



76139

## 1989 BATMOBILE™

LEGO and the LEGO logo are trademarks of the LEGO Group.  
©2019 The LEGO Group.



BATMAN and all related characters and elements  
© & ™ DC Comics and Warner Bros. Entertainment Inc.



WB SHIELD:  
© & ™ WBEI. (s19)

Source: 'The Building of the Batmobiles™' – from the DVD  
features of the Warner Brothers and 20th Century Fox releases

Source: Batmobile™ The Complete History by Mark Cotta Vaz

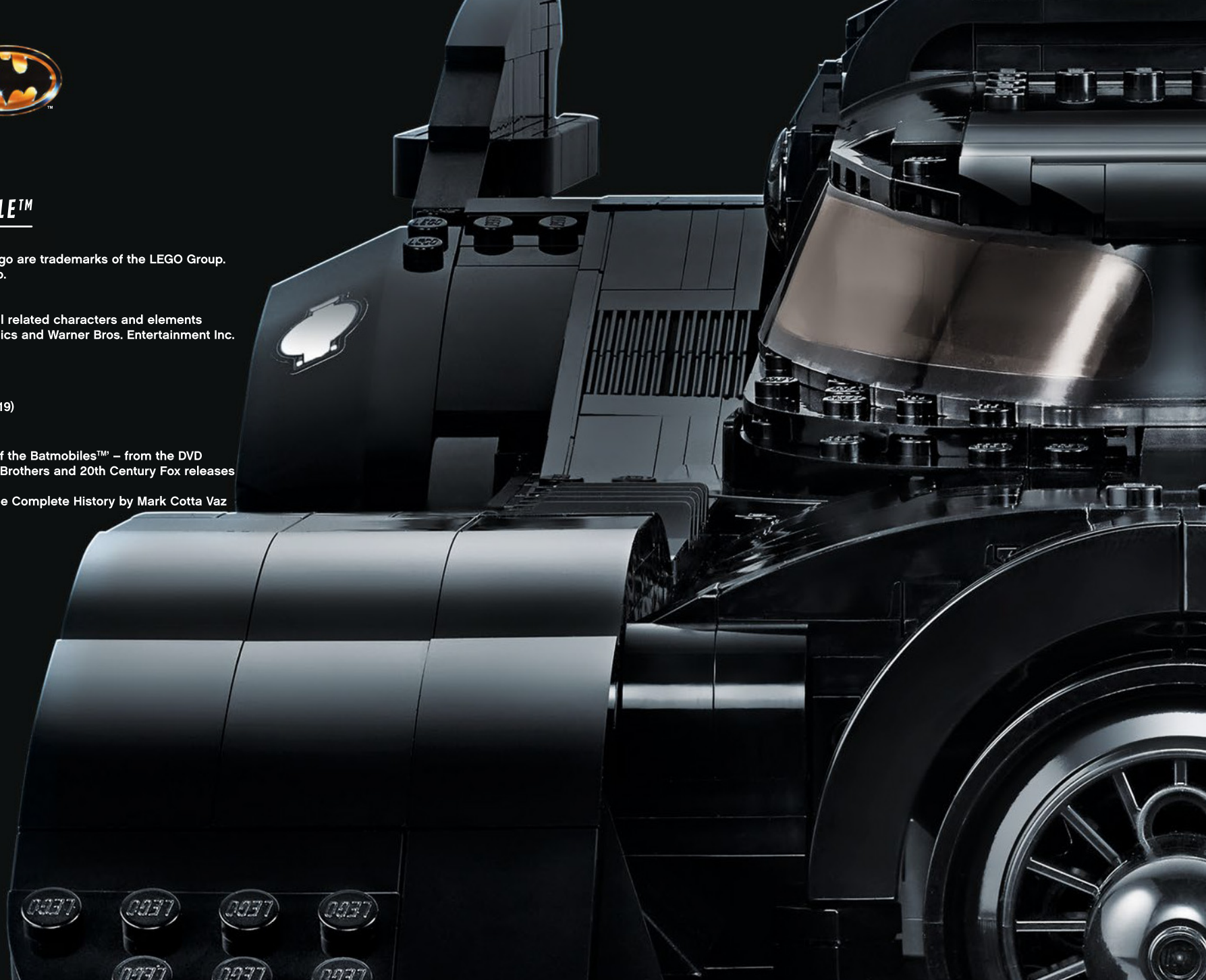

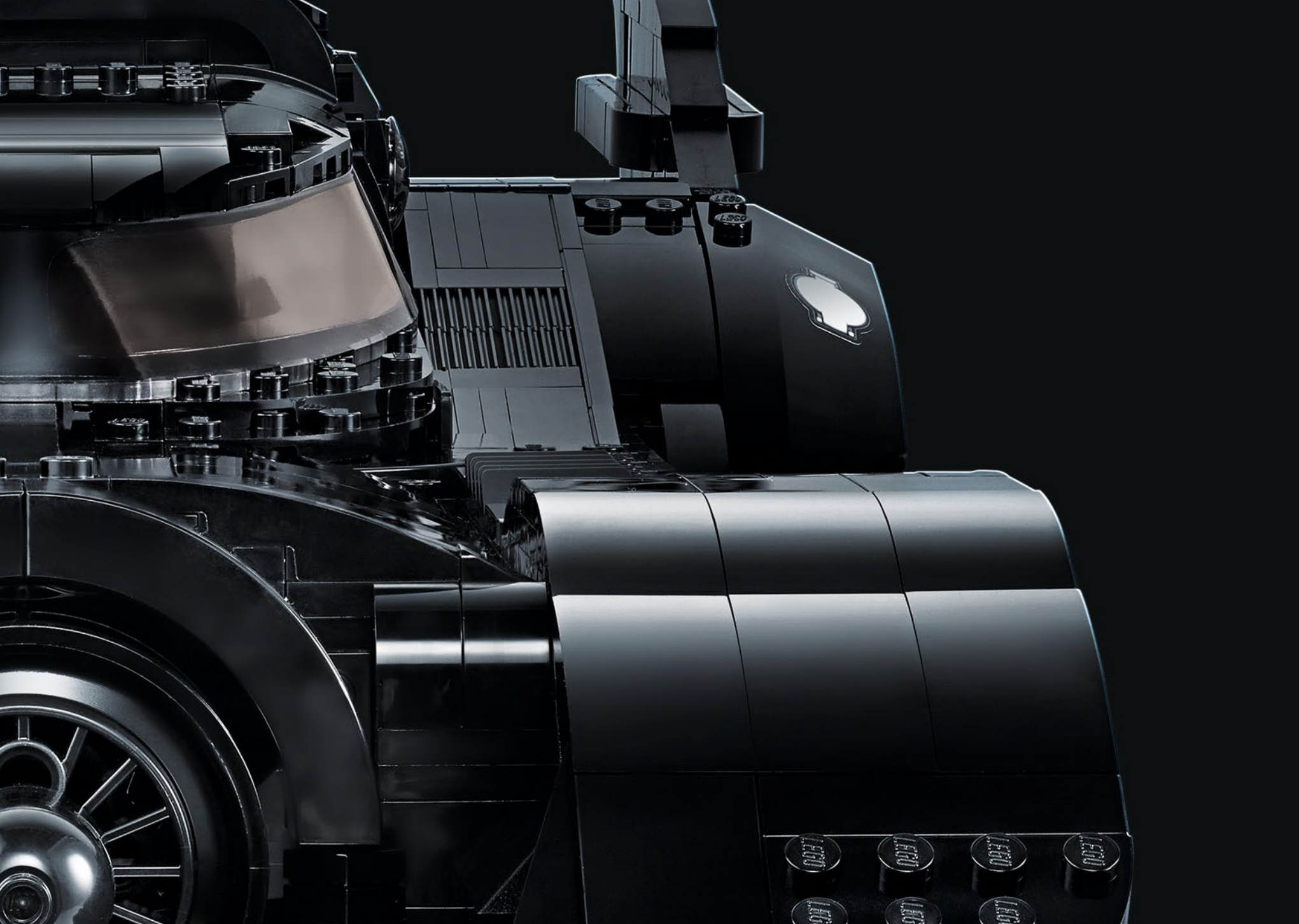

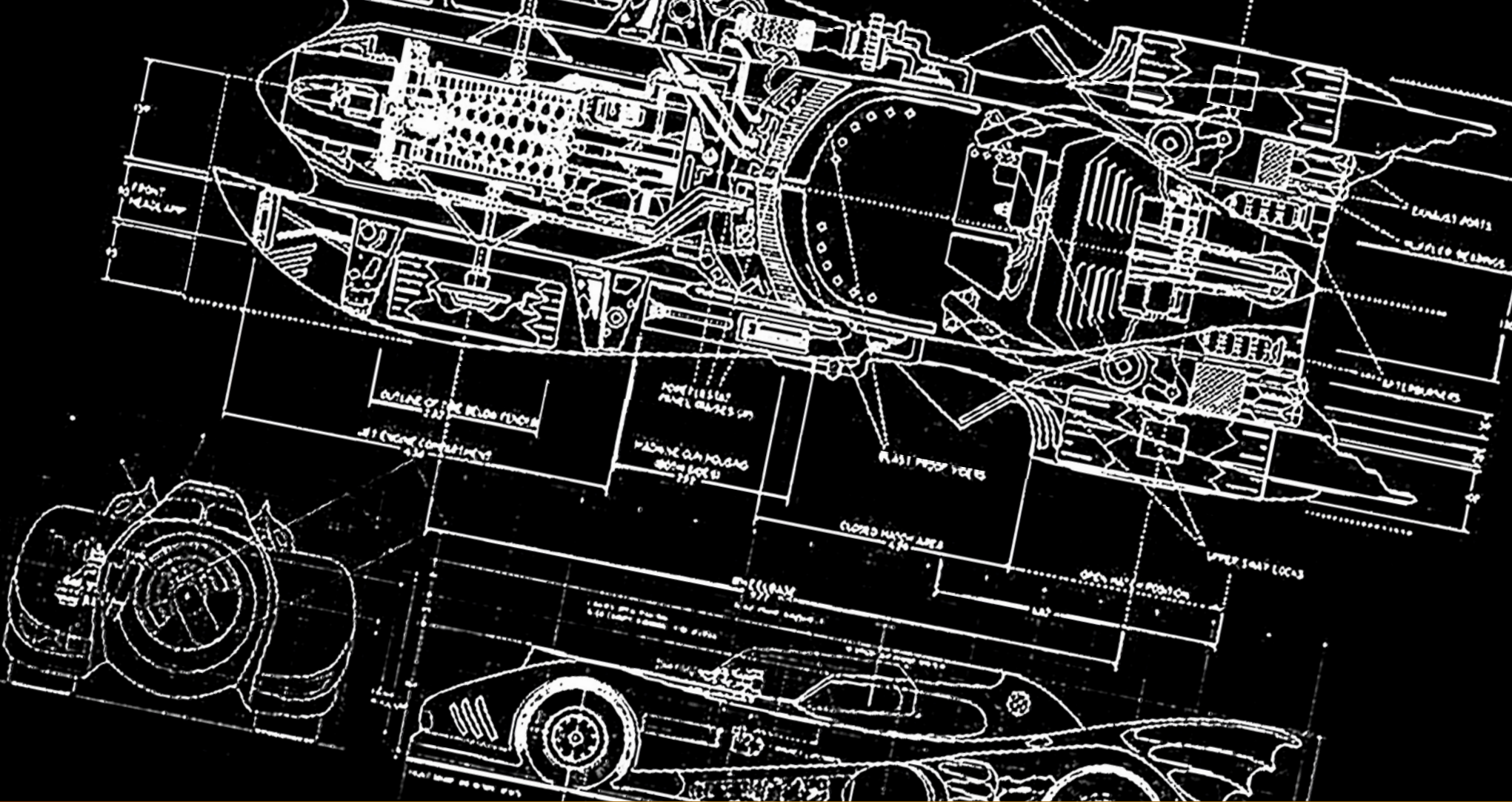

WHERE DOES HE GET THOSE WONDERFUL TOYS?"

– The JOKER™ (Batman™, 1989)

## THE INSPIRATION

For decades director Tim Burton has demonstrated his unique talent for and love of creating immersive and dark, relatable and beloved stories and characters like few others.

2019 marks the 30th anniversary of the release of the groundbreaking 1989 BATMAN™ movie. Its characters, sets and props brought us on a journey deep into a murky and mysterious new version of GOTHAM CITY™. An instant international phenomenon, it kickstarted a new era of Super Hero movies and set the bar for future generations of the ultimate Super Hero car – the BATMOBILE™.

In a collaboration with set designer Anton Furst and a team of creative designers, sheets of plywood, molded fiberglass, and some authentic car parts were transformed into not only the coolest Super Hero vehicle of its time, but an iconic character in its own right. It oozes the power, protection, darkness and destruction that still characterizes Batman to this day.

That is a legacy worth celebrating.



## THE DESIGN PROCESS

“We really enjoyed working with DC Comics and WARNER BROS™ to make this model come to life.

Our team of LEGO® designers wanted to make the most of one of the biggest brick-built LEGO cars we've ever released; they pushed the LEGO building system and their own skills, to new limits.

After researching every video, blueprint, screenshot and behind-the-scenes picture we could get our hands on, John Cuppage, Adam Grabowski, and Christopher Perron each worked on separate parts of the car, striving to get as close to the movie model as possible.”

– Jesper C. Nielsen, Design Manager

---

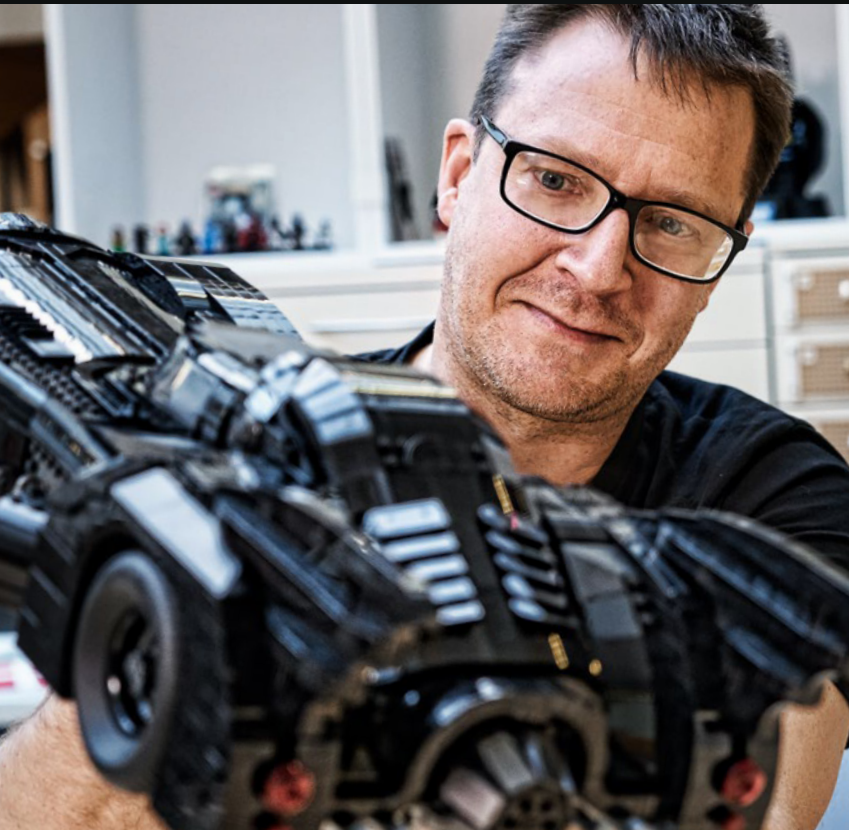



## CONCEPTUALIZING THE CAR

"I mostly worked on the first concept models, some of the functions and new elements. I built sketch models in different sizes based on existing LEGO® wheels, and we ended up using the tires from the 76023 The Tumbler (based on the vehicle from the BATMAN™ The Dark Knight Trilogy) as the rear tires.

My favorite features are the canopy, the sloped sides and steps to the cockpit. They set the stance and assertive personality of the car.

The 1989 movie is one of my earliest memories of Batman. I love the film and it was daunting to send photos of our work to Tim Burton before the model was finished!

I hope both he and the fans enjoy the final result as much as we do."

– John Cuppage, Senior Model Designer



**UPSIDE-DOWN HONDA™ CIVIC HEADLIGHTS PAINTED YELLOW**



**CURVED HEADLIGHTS REPLICATED ON THE LEGO® MODEL**



**CURVY WING DETAILS ON THE MOVIE MODEL**



**SIMILAR ANGLES WERE RECREATED ON THE LEGO MODEL**



## CURVES AND ANGLES

"We would tackle different sections at a time meaning we had to communicate very precisely what we needed room for, and to help each other to make it all fit. To ease this process, we sometimes all built together at one table (with the movie playing in the background).

The design is so iconic, and it's loved by fans everywhere – including us. You don't want to mess that up. We came up with some new building techniques to make the curves and angles blend together. 'How can we hinge this or attach that to match the original BATMOBILE™?' We'd look at one little shape and spend a full week trying to recreate it to get it just right!"

– *Chris Perron, Model Designer*

## PAYING TRIBUTE

"This was one of my favorite projects in my 12 years as a LEGO® designer.

I mainly worked on the chassis, the rear wings, the steering and the front. It's built to the same scale as The Tumbler, so they go together. We tried to create a model that gives you the same feeling as the movie model while making it stable and, not least, a great building experience for BATMAN™ and LEGO fans alike.

Tim Burton, Anton Furst and their team made it come alive. This is just our humble way of paying tribute to their vision and legacy."

– *Adam Grabowski, Senior Model Designer*



## IT'S ALL IN THE DETAILS

"Graphic Designer Ioana Popescu, Design Master Adam Corbally and I worked with the model and element designers to create graphic details for the BATMOBILE™ – brick-built details (printed elements) as well as stickers.

We researched reference images of the original Batmobile, especially the cockpit, to make every detail as authentic as possible.

For the BATMAN™ minifigure with the new dynamic cape element, we added a connection point design and printed the Batman logo on the cowl element. This way it seems like the cowl attaches to the torso, similar to how the costume appears in the film."

– Mark Tranter, Graphic Designer

## ONE-OF-A-KIND ELEMENTS

"For the new BATMAN™ cape and cowl, we wanted to emulate the movie costume's soft, 'rubber-like' materials and textures. At the time of the movie, this was unlike any suit Batman had ever worn before.

We wanted to find the perfect balance between the authentic look and our LEGO® DNA. One funny feature is that it is difficult for the Batman minifigure to turn his head. We think this is quite appropriate, as the actor apparently had a similar issue with the real costume!"

– Niels Milan Pedersen, Element Designer

"The biggest challenge for me was getting the windshield curves just right. It had to meet the Batman aesthetic requirements and still be strong enough to open and close the canopy. It took a few tries but now it fits naturally on the BATMOBILE™. And, of course, you can still use it with any other LEGO piece."

– Jaime Sanchez Potter, Element Designer



**PREDATOR &  
PROTECTOR...**







*IT'S NOT EXACTLY A NORMAL WORLD, IS IT?"*

— BATMAN™



## A DARK, BROODING VIGILANTE IN A TIMELESS UNIVERSE

The legacy of the CAPED CRUSADER™ is irrefutable. The year 2019 marks the 80th anniversary of his first appearance, in Detective Comics #27 from May 1939.

How does a hero stay true to character, yet adaptable enough to remain relevant in various incarnations and interpretations, through one of the most rapidly changing centuries in history?

GOTHAM CITY™ and its characters have continued to evolve to reflect the culture and society of each new generation of storytellers and filmmakers.

BRUCE WAYNE™ was always a complex character. He may have been born with the proverbial silver spoon in his mouth, but the childhood trauma of losing his parents to a seemingly random, vicious crime meant that nothing would ever come easy to him in life.

Wayne's alter ego BATMAN™ does not seek out fame or glory for his heroic actions – a common trait for all great heroes who have stood the test of time.

Batman does what he feels called to do to keep darkness at bay for those in need, only to disappear back into his own shadows with his BATCAVE™, BATSUIT™ and BATMOBILE™ as the ultimate shields against the world.

A hero shines most brightly in darkness, and Tim Burton is a master at creating rich, complex and beautiful darkness. In Burton's Batman movie, a deliberate mix of mismatched, classic and futuristic designs, architecture and styles brought the torment, extravagance and anarchy of the city to life as a surreal, timeless universe. These were the dark, miserable urban streets that left young Bruce an orphan and sealed his fate as the tormented, reclusive vigilante.

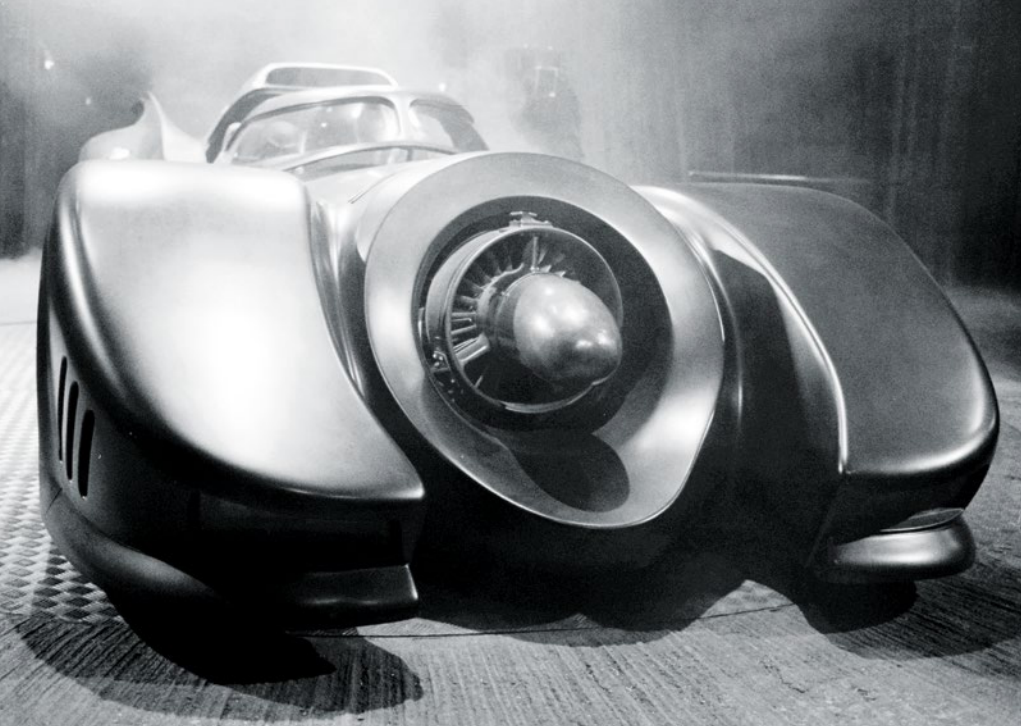

## STAYING TRUE TO A VISION

Fans of the BATMAN™ universe and movie critics were anxious to see Tim Burton's vision of the Dark Knight. Many feared the movie would continue down the light-hearted path set by earlier TV shows. But Tim Burton, Anton Furst and a dedicated team of prop and set designers were always aligned on a vision to bring back the brutality and complexity of the comic book universe. Their creative, yet faithful portrayal of the original hero eventually put every fear to rest.

The BATMOBILE™ was designed and built to roam and rule the crime-ridden streets of GOTHAM CITY™. As a symbol of order and justice in all the chaos, it can blend into the shadows, ready to shoot into action at a moment's notice when the city's citizens are in danger.

A sleek, aggressive exterior was achieved with parts and inspiration from modern as well as classic cars and jet fighter planes. The result: a torpedo of a vehicle with enough muscle to protect its hero, save the occasional damsel in distress and, of course, stop villains.

It is the perfect representative of a world that still inspires us to explore our own darkness, spark our curiosity and creativity, and discover our heroic instincts.





***...AND NOW I'VE GOTTA GO TO WORK."***

**– BRUCE WAYNE™**

With 24 bags containing 3.5 kg of bricks – almost 3,300 pieces – it's time to build your own piece of the BATMAN™ universe and let it take its rightful place in your memorabilia collection, living room, office or BATCAVE™.

---



76139

## BATMOBILE™ 1989

LEGO et le logo LEGO sont des marques de commerce du Groupe LEGO.  
©2019 The LEGO Group.



BATMAN and all related characters and elements  
© & ™ DC Comics and Warner Bros. Entertainment Inc.



WB SHIELD:  
© & ™ WBEI. (s19)

Source : The Building of the Batmobiles™ – extraits du DVD,  
films de Warner Brothers et de 20th Century Fox

Source : Batmobile™: The Complete History, par Mark Cotta Vaz



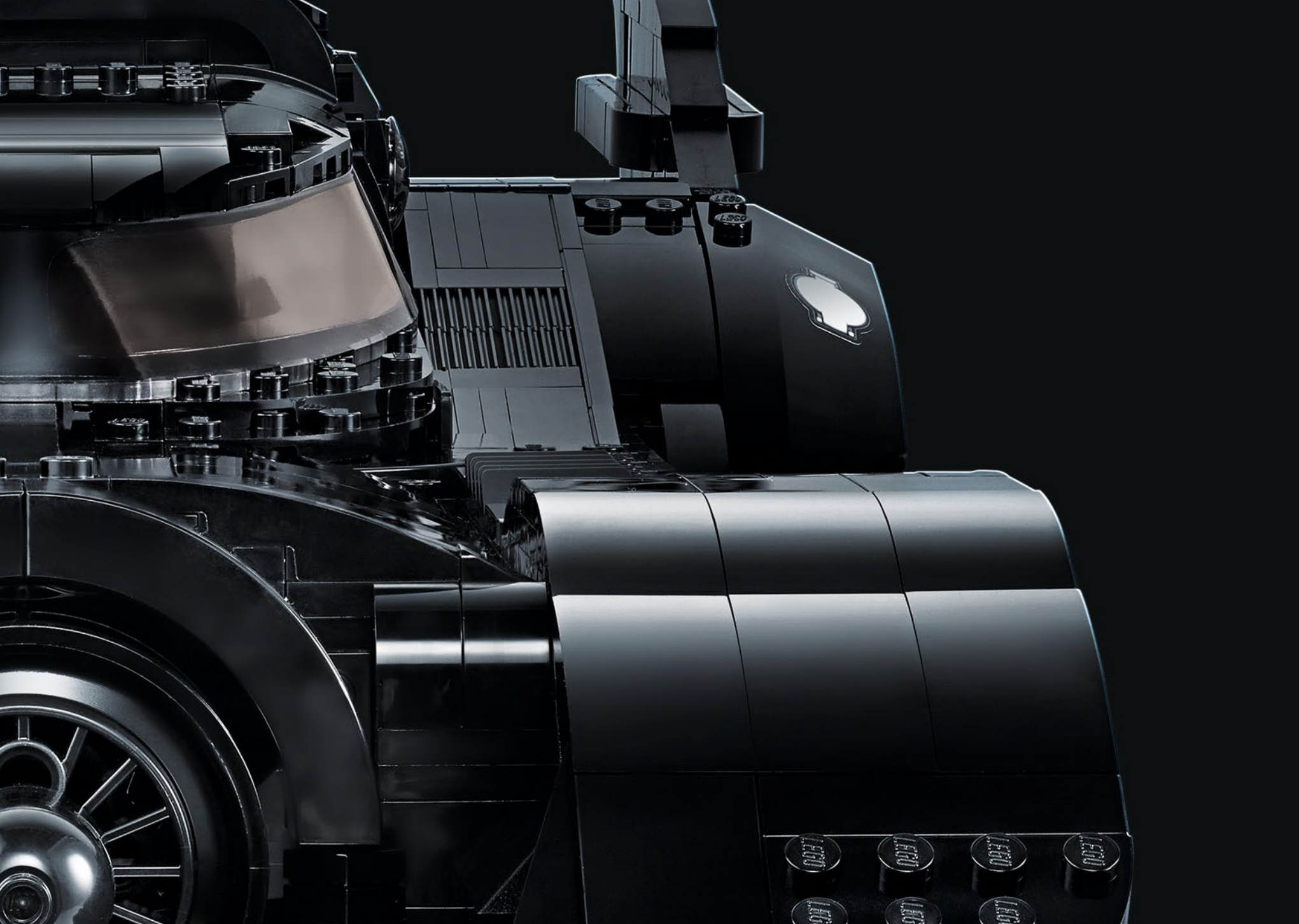

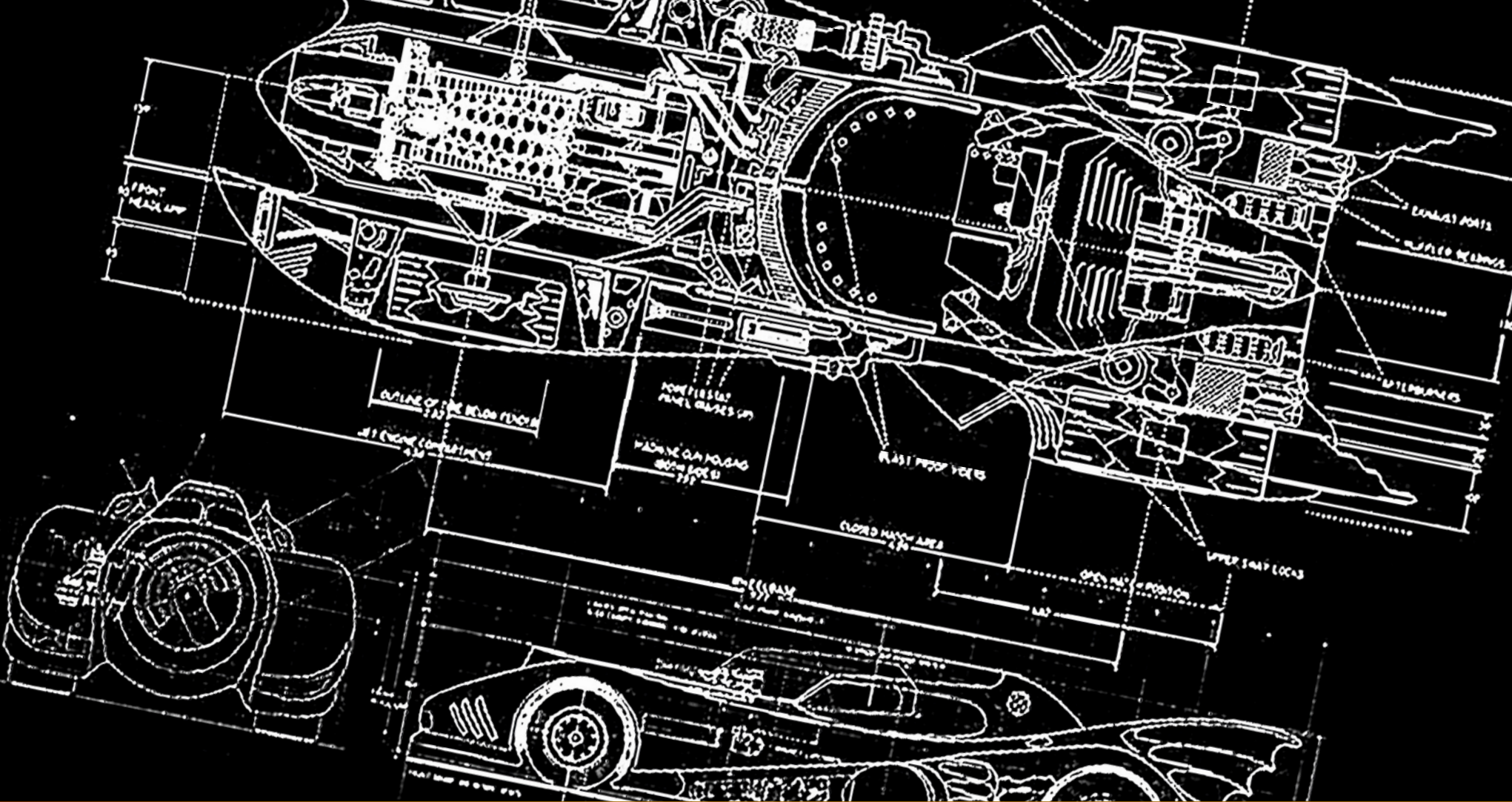

OÙ TROUVE-T-IL CES FANTASTIQUES JOUETS?"

— le Joker™ (Batman™, 1989)

## L'INSPIRATION

Depuis des décennies, le réalisateur Tim Burton a su démontrer son talent unique et son amour pour la création d'histoires passionnantes, immersives et sombres et de personnages peu communs.

L'année 2019 marque le 30e anniversaire de la sortie du révolutionnaire film Batman™ de 1989. Ses personnages, ses décors et ses accessoires nous ont plongés dans les profondeurs d'une nouvelle version de GOTHAM CITY™, obscure et mystérieuse. Ce phénomène international instantané a donné le coup d'envoi à une nouvelle ère de films de superhéros et a servi de référence

pour les futures générations de la voiture de superhéros par excellence : la Batmobile™.

En collaboration avec le concepteur de décors Anton Furst et une équipe de concepteurs artistiques, des feuilles de contreplaqué, des fibres de verre moulées et certaines pièces d'automobile authentiques ont été transformées non seulement en la voiture de superhéros la plus cool de son époque, mais également en un personnage emblématique à part entière. Cette voiture incarne la puissance, la protection, la noirceur et la destruction qui caractérisent encore Batman à ce jour. C'est un héritage qui mérite d'être célébré.



## LE PROCESSUS DE CONCEPTION

« Nous avons vraiment aimé travailler avec DC COMICS et WARNER BROS™ pour donner vie à ce modèle.

Notre équipe de concepteurs LEGO® souhaitait tirer le meilleur parti de l'une des plus grandes voitures en briques LEGO jamais mises sur le marché, repoussant les limites du système de construction LEGO et de leurs propres compétences.

Après avoir examiné l'ensemble des vidéos, des plans, des captures d'écran et des photos dans les coulisses que nous avons sous la main, John Cuppage, Adam Grabowski et Christopher Perron ont travaillé sur des parties distinctes de la voiture, s'efforçant de se rapprocher autant que possible du modèle du film. »

– Jesper C. Nielsen, responsable de la conception

---

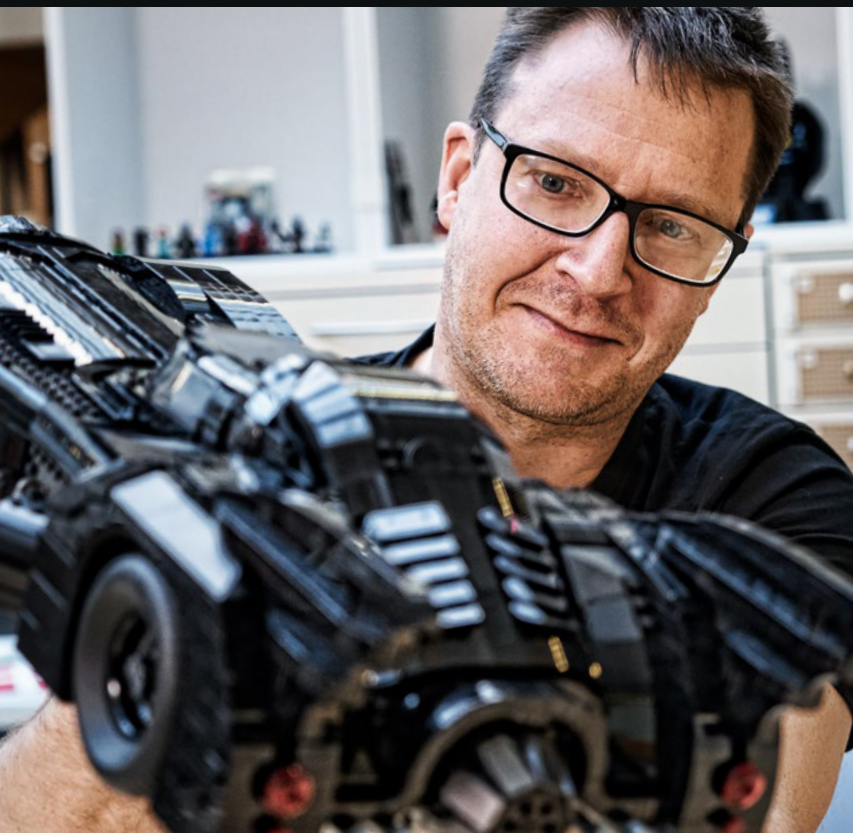



## CONCEPTUALISATION DE LA VOITURE

« J'ai principalement travaillé sur les premiers modèles de concept, certaines fonctions et de nouveaux éléments.

J'ai créé des esquisses de modèles de différentes tailles en me basant sur les roues LEGO® existantes, et nous avons fini par utiliser les pneus du Tumbler 76023 (inspirés du véhicule de la trilogie de Batman™, Le Chevalier noir) comme pneus arrière.

Mes éléments préférés sont le toit, les côtés inclinés et le cockpit, qui confèrent à la voiture son attitude et sa personnalité affirmée.

Le film de 1989 est l'un de mes premiers souvenirs de Batman. J'adore le film, et c'était intimidant d'envoyer des photos de notre travail à Tim Burton avant que le modèle soit fini! J'espère que lui et les fans apprécieront le résultat final autant que nous. »

– John Cuppage, concepteur principal de modèles



**PHARES PEINTS EN JAUNE D'UNE HONDA™ CIVIC À L'ENVERS**



**PHARES COURBÉS REPRODUITS SUR LE MODÈLE LEGO®**

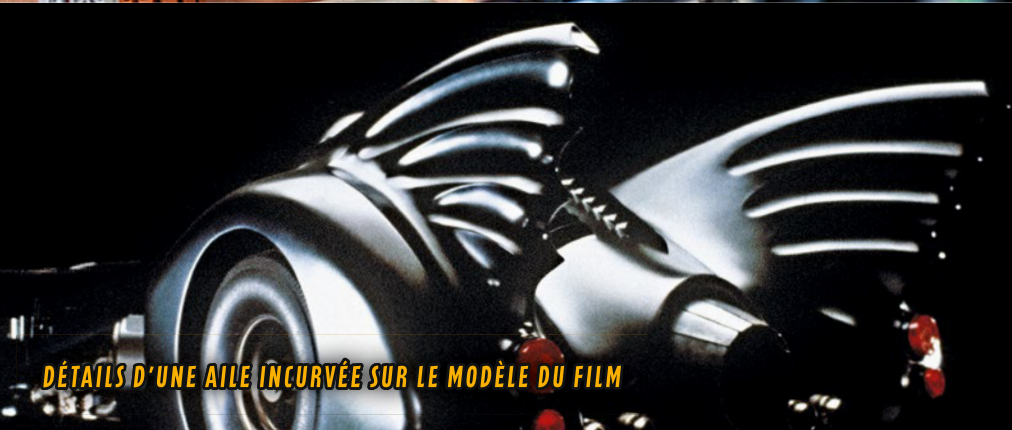

**DÉTAILS D'UNE AILE INCURVÉE SUR LE MODÈLE DU FILM**



**DES ANGLES SEMBLABLES ONT ÉTÉ RECRÉÉS SUR LE MODÈLE LEGO®**



## COURBES ET ANGLES

« Comme nous travaillions sur différentes parties à la fois, nous devons nous dire précisément de quel espace nous avons besoin et nous entraider pour que tout soit bien assemblé. Pour faciliter ce processus, parfois, nous construisions tout sur la même table (en écoutant le film comme toile de fond).

Il s'agit d'un design si emblématique, aimé par les fans de partout dans le monde (y compris nous-mêmes). Nous ne voulions rien gâcher. Nous avons trouvé de nouvelles techniques de construction pour combiner les courbes et les angles. Nous nous demandions comment ajouter telle charnière ou telle pièce pour que notre modèle corresponde à la Batmobile™ originale. Nous examinions une petite forme, et nous pouvions passer une semaine entière à essayer de la recréer parfaitement! »

– *Chris Perron, concepteur de modèles*

## RENDRE HOMMAGE

« Au cours de mes 12 années en tant que concepteur LEGO®, ce fut l'un de mes projets préférés.

J'ai surtout travaillé sur le châssis, les ailes arrière, la direction et le devant du véhicule. Il est construit à la même échelle que le Tumbler, donc ils vont de pair. Nous avons essayé de concevoir un modèle inspirant les mêmes sentiments que le modèle du film tout en le rendant stable et, surtout, de créer une excellente expérience de construction tant pour les fans de Batman™ que pour ceux de LEGO.

Tim Burton, Anton Furst et leur équipe lui ont donné vie. Nous rendons donc humblement hommage à leur vision et à leur héritage. »

– *Adam Grabowski, concepteur principal de modèles*



## CHAQUE DÉTAIL COMPTE

« Les graphistes Ioana Popescu et Adam Corbally et moi-même avons travaillé avec les concepteurs de modèles et d'éléments afin de créer des détails graphiques pour les briques de la Batmobile™ (éléments imprimés) ainsi que des autocollants.

Nous avons cherché des images de référence de la Batmobile originale, notamment du cockpit, pour rendre tous les détails aussi authentiques

que possible. Pour la figurine de Batman™ dotée du nouvel élément de cape dynamique, nous avons ajouté un point d'ancrage et un imprimé du logo de Batman sur le capuchon. Ainsi, le capuchon semble rattaché au torse, un peu comme le costume que nous voyons dans le film. »

– Mark Tranter, graphiste

## ÉLÉMENTS UNIQUES

« Pour la nouvelle cape et le nouveau capuchon de Batman™, nous avons voulu imiter les textures et les matériaux lisses et "caoutchouteux" du costume du film. À l'époque du film, cela ne ressemblait à aucun autre costume que Batman avait porté.

Nous voulions trouver l'équilibre parfait entre le look authentique et notre ADN LEGO®. Ce qui est amusant, c'est que la figurine de Batman a de la difficulté à tourner la tête. Nous trouvions cela tout à fait approprié, car l'acteur semble éprouver le même problème avec le vrai costume! »

– Niels Milan Pedersen, concepteur d'éléments

« Le plus grand défi pour moi était de recréer parfaitement les courbes du pare-brise du véhicule. Celui-ci devait répondre aux exigences esthétiques de Batman et être assez solide pour que le toit puisse s'ouvrir et se fermer. Il nous a fallu quelques essais, mais maintenant, il convient parfaitement à la Batmobile™. Et bien sûr, vous pouvez l'utiliser avec n'importe quelle autre pièce LEGO. »

– Jaime Sanchez Potter, concepteur d'éléments



**PRÉDATEUR ET  
PROTECTEUR ...**







*CE N'EST PAS VRAIMENT UN MONDE NORMAL, SI?"*

— Batman™



## UN JUSTICIER SOMBRE ET TOURMENTÉ DANS UN UNIVERS INTEMPOREL

L'héritage du Justicier masqué est indéniable. L'année 2019 marque le 80e anniversaire de sa première apparition, dans le numéro 27 de la bande dessinée Detective Comics de mai 1939.

Comment un héros a-t-il pu rester fidèle à son personnage tout en s'adaptant suffisamment afin de demeurer pertinent dans diverses personifications et interprétations, au cours des siècles de l'histoire ayant évolué le plus rapidement?

GOTHAM CITY™ et ses personnages ont continué d'évoluer afin de refléter la culture et la société de chaque nouvelle génération de conteurs et de cinéastes.

Bruce Wayne™ a toujours été un personnage complexe. Il est peut-être né avec la proverbiale cuillère d'argent dans la bouche, mais ayant subi un traumatisme d'enfance dû à la perte de ses parents en raison d'un crime odieux, apparemment arbitraire, sa vie ne serait jamais facile.

Batman™, l'alter ego de Bruce Wayne, ne cherche pas à acquérir la gloire ni la célébrité pour ses actes héroïques, et il s'agit d'une caractéristique commune de tous les grands héros ayant résisté à l'épreuve du temps. Batman fait ce qu'il se sent appelé à faire pour préserver des ténèbres les personnes dans le besoin, mais c'est pour mieux se réfugier dans l'ombre de sa Batcave™, de son Batsuit™ et de sa Batmobile™, qui sont de précieux boucliers contre le monde.

Un héros brille toujours plus dans l'obscurité, et Tim Burton est passé maître dans l'art de créer des ténèbres intenses, complexes et magnifiques. Dans le film Batman de Tim Burton, un amalgame délibéré de designs, d'éléments architecturaux et de styles disparates, classiques et futuristes donne vie à la ville tourmentée, extravagante et anarchique de cet univers surréaliste et intemporel. C'est au cœur des rues sombres et misérables de cette ville que Bruce est devenu orphelin et que son destin de justicier solitaire et tourmenté a été scellé.

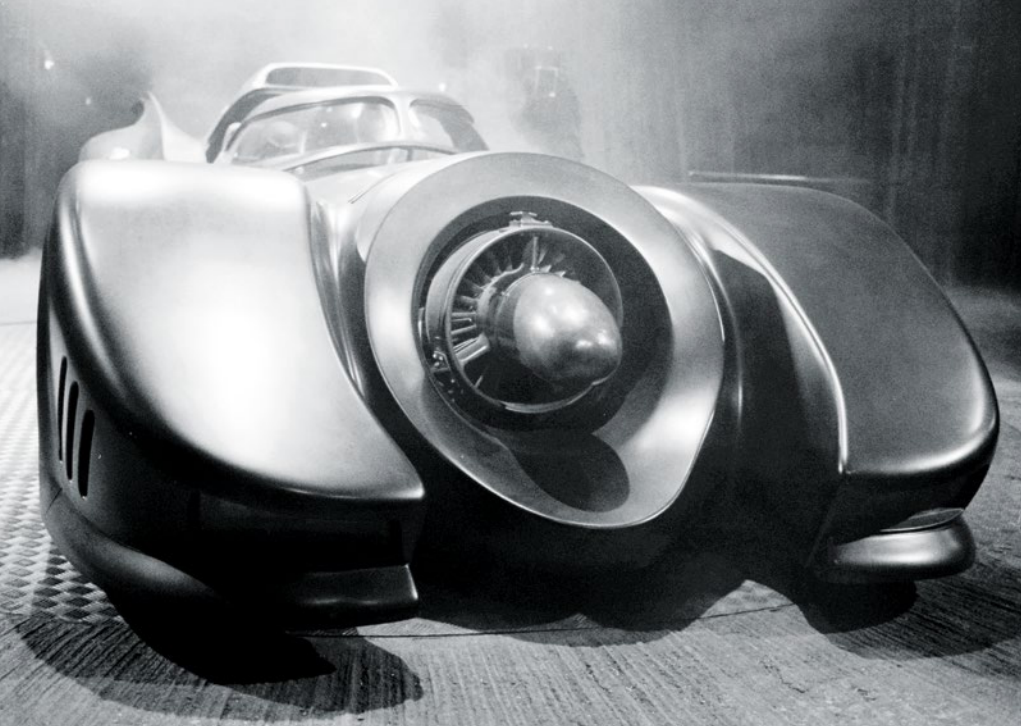

## RESTER FIDÈLE À UNE VISION

Les fans de l'univers de Batman™ et les critiques de films avaient hâte de découvrir la vision du Chevalier noir de Tim Burton. Bien des gens craignaient que le film continue d'adopter le ton joyeux des émissions de télévision précédentes. Mais Tim Burton, Anton Furst et une équipe spécialisée de concepteurs d'accessoires et de décors s'étaient toujours entendus sur la même vision : celle de ressusciter la brutalité et la complexité de l'univers de la bande dessinée. Leur représentation créative, mais fidèle du héros original, ont fini par apaiser les craintes.

La Batmobile™ a été conçue et construite pour patrouiller et régner dans les rues souillées par le crime de GOTHAM CITY™. Tel un symbole de l'ordre et de la justice dans le chaos, elle se fond dans les ténèbres, prête à passer à l'action à tout moment lorsque des citoyens de la ville sont en danger.

Son extérieur élégant et agressif a été réalisé à l'aide de pièces et d'idées inspirées des voitures modernes et classiques et des avions de combat. Le résultat : un véhicule explosif, assez puissant pour protéger son héros, sauver la demoiselle en détresse et, bien sûr, combattre les méchants.

Il représente parfaitement un monde qui éveille notre curiosité et notre créativité et qui nous incite à explorer nos propres ténèbres et à développer nos instincts de héros.





**... ET MAINTENANT, JE DOIS TRAVAILLER."**

**– Bruce Wayne™**

Avec vos 24 sacs contenant 3,5 kg de briques (presque 3 300 pièces), il est temps de créer votre propre œuvre de l'univers de Batman™ et de lui laisser la place qui lui revient dans votre collection de souvenirs, votre salon, votre bureau ou votre Batcave™.

---



76139

## 1989 BATMOBILE™

LEGO y el logotipo de LEGO son marcas registradas de The LEGO Group.  
©2019 The LEGO Group.



BATMAN and all related characters and elements  
© & ™ DC Comics and Warner Bros. Entertainment Inc.



WB SHIELD:  
© & ™ WBEI. (s19)

Fuente: The Building of the Batmobiles™, de los extras de los DVD  
publicados por Warner Brothers y 20th Century Fox

Fuente: Batmobile™: The Complete History, de Mark Cotta Vaz



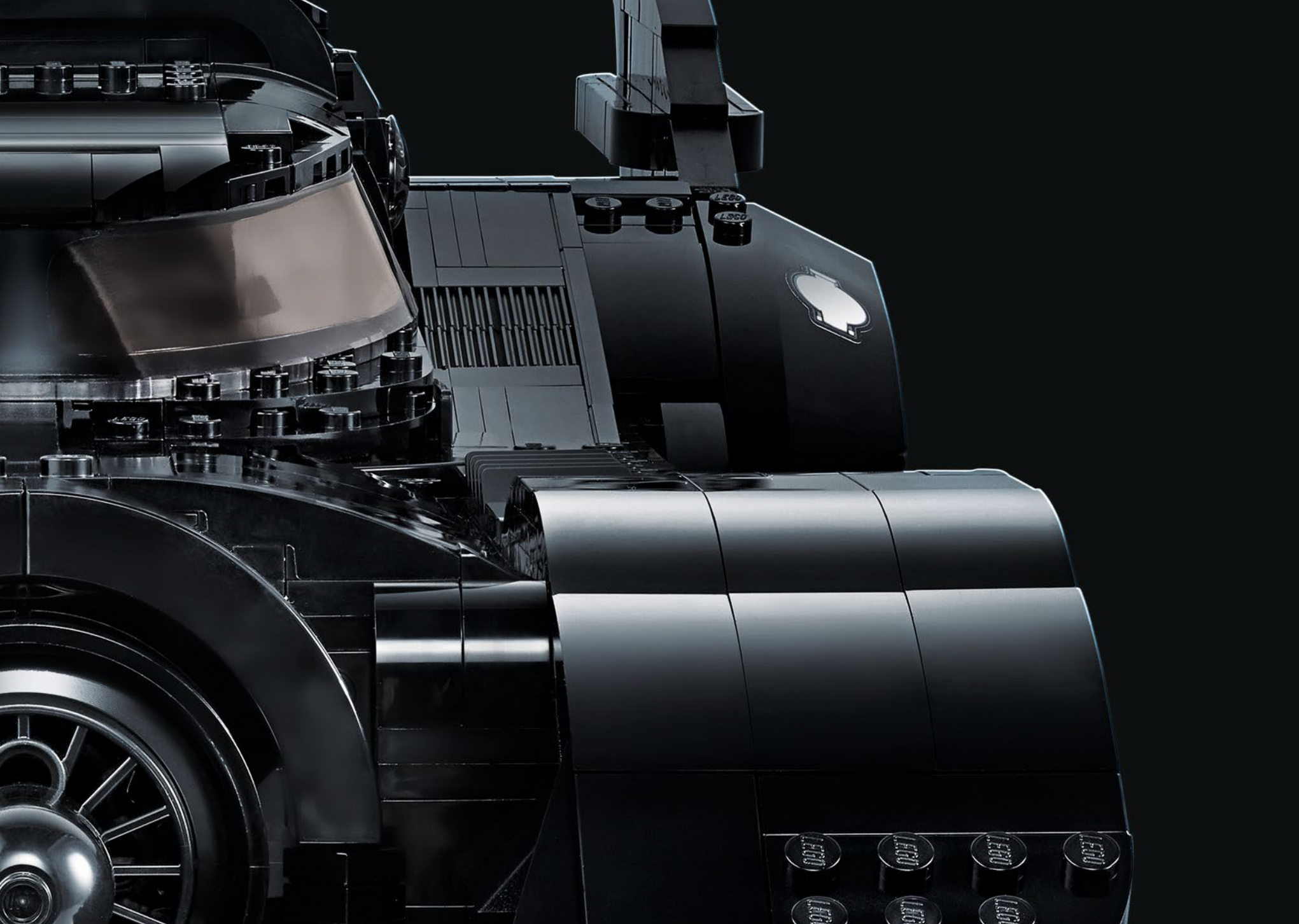

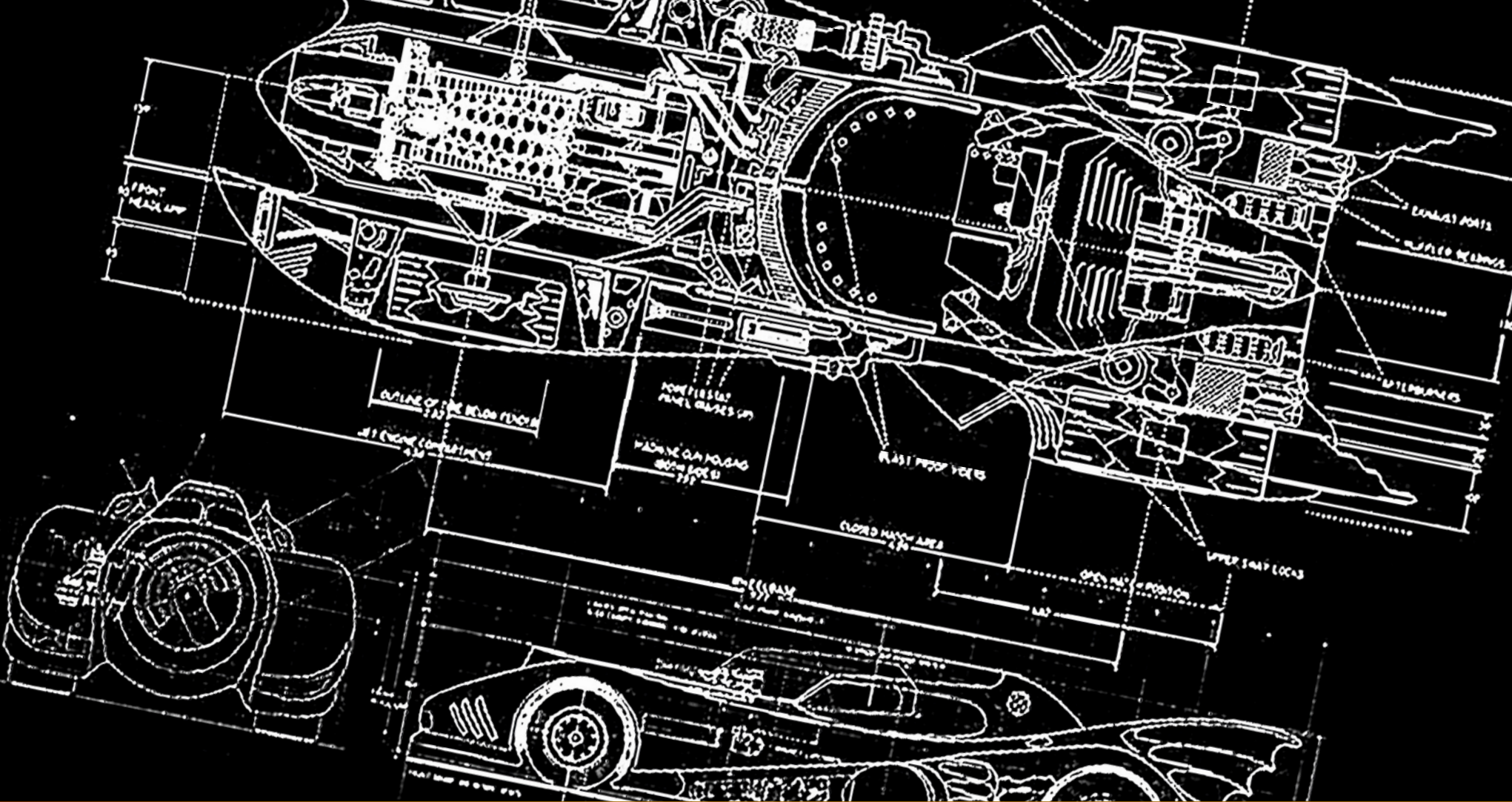

¿DE DÓNDE SACARÁ ESA MARAVILLA DE JUGUETES?"

– The Joker™ (Batman™, 1989)

## LA INSPIRACIÓN

Durante décadas, el director Tim Burton ha demostrado un singular talento, así como su pasión por crear historias y personajes cautivadores y oscuros con quienes llegas a identificarte y que se ganan el afecto del público.

En 2019 se cumplen 30 años del estreno de la revolucionaria Batman™ de 1989. Sus personajes, decoraciones y objetos de utilería nos permitieron adentrarnos en lo más profundo de una nueva versión de GOTHAM CITY™, más oscura y misteriosa. Fue un éxito internacional instantáneo que dio comienzo a una nueva era de películas de superhéroes y sentó las bases de las futuras

generaciones del mejor auto que puede tener un superhéroe: el Batmobile™.

En colaboración con el escenógrafo Anton Furst y un equipo de creativos diseñadores, unas cuantas láminas de madera contrachapada, un poco de fibra de vidrio moldeada y algunas piezas de autos de verdad se transformaron no solo en el vehículo más padre para un superhéroe de su tiempo, sino también en un personaje icónico por derecho propio. Irradia la potencia, la protección, la oscuridad y la destrucción que todavía hoy caracterizan a Batman. Es un legado que vale la pena celebrar.



## EL PROCESO DE DISEÑO

“Realmente disfrutamos trabajando con DC COMICS y WARNER BROS™ para hacer realidad este modelo.

Los miembros del equipo de diseñadores de LEGO® querían sacar el máximo provecho de uno de los autos de bricks LEGO más grandes que hayamos lanzado nunca; traspasaron las fronteras del sistema de construcción LEGO y también las de sus propias habilidades.

Después de analizar cada video, plano, captura de pantalla y fotografía tras bambalinas que pudimos obtener, John Cuppage, Adam Grabowski y Christopher Perron trabajaron cada uno en diferentes partes del auto, esforzándose por acercarse tanto como fuera posible al modelo de la película”.

– Jesper C. Nielsen, jefe de diseño

---

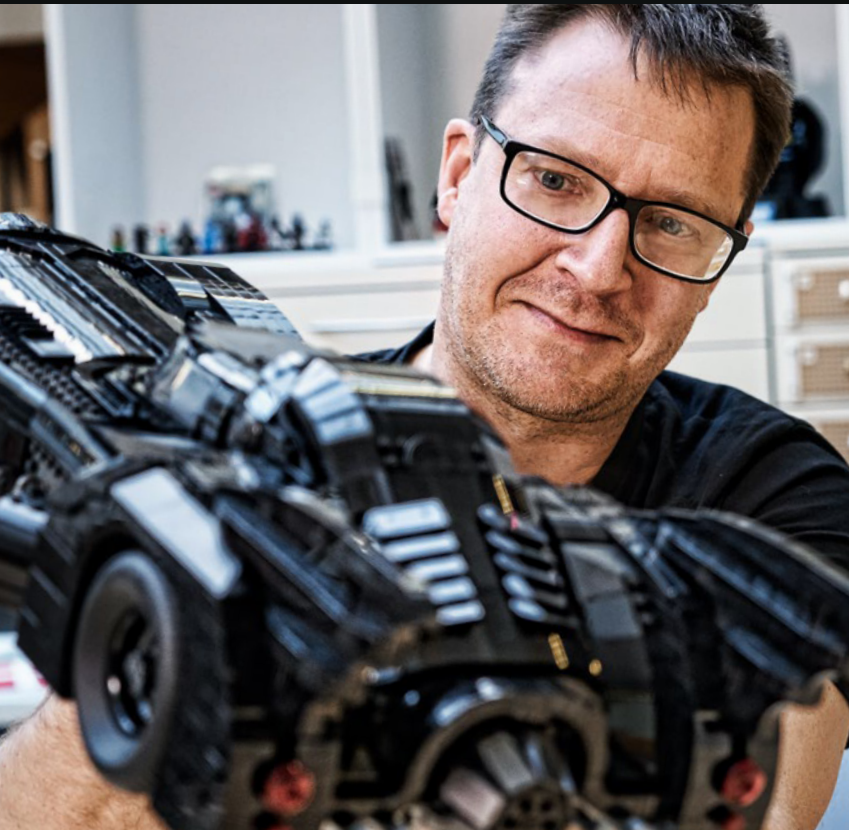



## LA CONCEPCIÓN DEL AUTO

“Trabajé sobre todo en los primeros prototipos del modelo, algunas de las funciones y unos cuantos elementos nuevos. Construí modelos preliminares de diferentes tamaños basados en las llantas LEGO® que tenemos y acabamos usando las ruedas del Tumbler (76023), basado en el vehículo que usa Batman™ en la trilogía de El Caballero Oscuro, como llantas traseras.

Mis rasgos favoritos son la cubierta, los paneles laterales inclinados y los escalones que dan acceso a la cabina. Determinan la actitud y la personalidad asertiva del auto.

La película de 1989 es uno de mis primeros recuerdos de Batman. ¡Me encanta el film y fue un poco abrumador enviarle fotos de nuestro trabajo a Tim Burton antes de que el modelo estuviera terminado!

Espero que el resultado final les guste tanto a él y a los fans como nos gusta a nosotros”.

– John Cuppage, diseñador sénior de modelos



**FAROS DELANTEROS DE UN HONDA™ CIVIC VOLTEADOS, PINTADOS DE AMARILLO**



**FAROS DELANTEROS CURVADOS, REPRODUCIDOS EN EL MODELO LEGO®**



**DETALLE DE LAS ALETAS AERODINÁMICAS DEL MODELO DE LA PELÍCULA**



**SE RECREARON ÁNGULOS SIMILARES PARA EL MODELO LEGO®**



## CURVAS Y ÁNGULOS

“Trabajábamos en diferentes secciones al mismo tiempo, por lo que teníamos que comunicar con mucha precisión para qué necesitábamos espacio y ayudarnos entre nosotros para que todas las piezas encajaran. Para facilitar ese proceso, a veces construíamos todos juntos en la misma mesa (con la película de fondo).

Es un diseño inconfundible que todos los fans del mundo adoran, incluidos nosotros. Hay que pisar con cuidado en ese terreno. Se nos ocurrieron algunas técnicas de construcción novedosas para que las curvas y los ángulos se integraran bien. ‘¿Cómo podemos poner aquí una bisagra o conectar aquello para que quede como en el Batmobile™ original?’. ¡Nos concentrábamos en una pequeña forma y nos pasábamos una semana entera tratando de recrearla para que quedara perfecta!”.

– Chris Perron, diseñador de modelos

## UN HOMENAJE

“Este fue uno de los proyectos que más me han gustado en los 12 años que llevo como diseñador en LEGO®.

Trabajé principalmente en el chasis, las aletas traseras, la dirección y el frente. Está hecho a la misma escala que el Tumbler, así que se complementan. Intentamos crear un modelo que te hiciera sentir lo mismo que el modelo de la película, que fuera estable y, no menos importante, que representara una excelente experiencia de construcción tanto para los fans de Batman™ como para los de LEGO.

Tim Burton, Anton Furst y su equipo fueron quienes lograron que cobrara vida. Esta no es más que una humilde forma de rendir homenaje a su visión y legado”.

– Adam Grabowski, diseñador sénior de modelos



## EL SECRETO ESTÁ EN LOS DETALLES

“La diseñadora gráfica Ioana Popescu, el maestro de diseño Adam Corbally y yo trabajamos con los diseñadores de modelos y elementos para crear los detalles gráficos del Batmobile™: tanto los que se construyen con bricks (elementos impresos) como las calcomanías.

Estudiamos numerosas imágenes de referencia del Batmobile original, especialmente de la cabina, para que todos los detalles se apegaran a la realidad

tanto como fuera posible. Para la minifigura de Batman™ con la nueva capa dinámica, agregamos un punto de conexión al diseño e imprimimos el logotipo de Batman en el elemento de la capucha. De esta manera, parece que la capucha está unida al torso, tal como sucede en el caso del traje que luce el personaje en la película”.

– Mark Tranter, diseñador gráfico

## ELEMENTOS A LA MEDIDA

“Para la nueva capa y capucha de Batman™, queríamos emular los materiales flexibles y las texturas del traje de la película, que parecía estar hecho de goma. Cuando se estrenó el film, el traje de Batman no se parecía a ningún otro que hubiera usado antes.

Queríamos encontrar el equilibrio perfecto entre el realismo estético y el ADN de LEGO®. Un detalle curioso es que a la minifigura de Batman le resulta difícil girar la cabeza. Creemos que es muy acertado, ¡ya que el protagonista parecía tener un problema similar con el traje de verdad!”.

– Niels Milan Pedersen, diseñador de elementos

“Para mí, el mayor desafío fue lograr que las curvas del parabrisas quedaran perfectas. Tenían que cumplir los requisitos estéticos de Batman y, aun así, ser lo suficientemente fuertes como para soportar la apertura y el cierre de la cubierta de la cabina. Nos tomó varios intentos, pero ahora se ajusta con mucha naturalidad en el Batmobile™. Y, cómo no, puedes usarla con cualquier otra pieza LEGO”.

– Jaime Sanchez Potter, diseñador de elementos



**DEPREDADOR Y  
PROTECTOR...**







*TAMPOCO EL MUNDO ES DEMASIADO NORMAL"*

– Batman™



## UN OSCURO Y MELANCÓLICO VIGILANTE EN UN UNIVERSO SIN EDAD

El legado del Cruzado de la Capa es irrefutable. En 2019 se cumplen 80 años de su primera aparición, en el número 27 de Detective Comics, publicado en mayo de 1939.

¿Cómo logra un héroe mantenerse fiel a su carácter, adaptándose al mismo tiempo lo suficiente como para seguir siendo relevante en diferentes encarnaciones e interpretaciones, a lo largo de uno de los siglos de más rápida evolución de la historia?

GOTHAM CITY™ y sus personajes se han ido desarrollando para reflejar la cultura y la sociedad de cada nueva generación de narradores y cineastas.

Bruce Wayne™ siempre ha sido un personaje complejo. Puede haber nacido con la proverbial cuchara de plata en la boca, pero el trauma infantil de perder a sus padres a causa de un crimen aparentemente aleatorio y despiadado le anunció que nada le sería fácil en la vida.

El *alter ego* de Wayne, Batman™, no busca fama ni gloria por sus acciones heroicas: un rasgo común a todos los grandes héroes que han soportado el paso del tiempo. Batman hace lo que se siente destinado a hacer para mantener la oscuridad a raya y ayudar a quienes o necesitan, para luego desaparecer entre sus propias sombras, con su Batcave™, su Batsuit™ y su Batmobile™ como infranqueables escudos contra el mundo.

En la oscuridad es donde más brilla un héroe, y Tim Burton es un genio a la hora de crear la más profunda, compleja y hermosa oscuridad. En la película Batman de Burton, una mezcla de diseños, arquitecturas y estilos clásicos y futuristas deliberadamente dispares dio vida al tormento, la extravagancia y la anarquía de la ciudad en un universo surrealista y extemporáneo. Fueron esas oscuras calles de miseria urbana las que dejaron huérfano al joven Bruce y sellaron su destino como el atormentado y solitario vigilante.

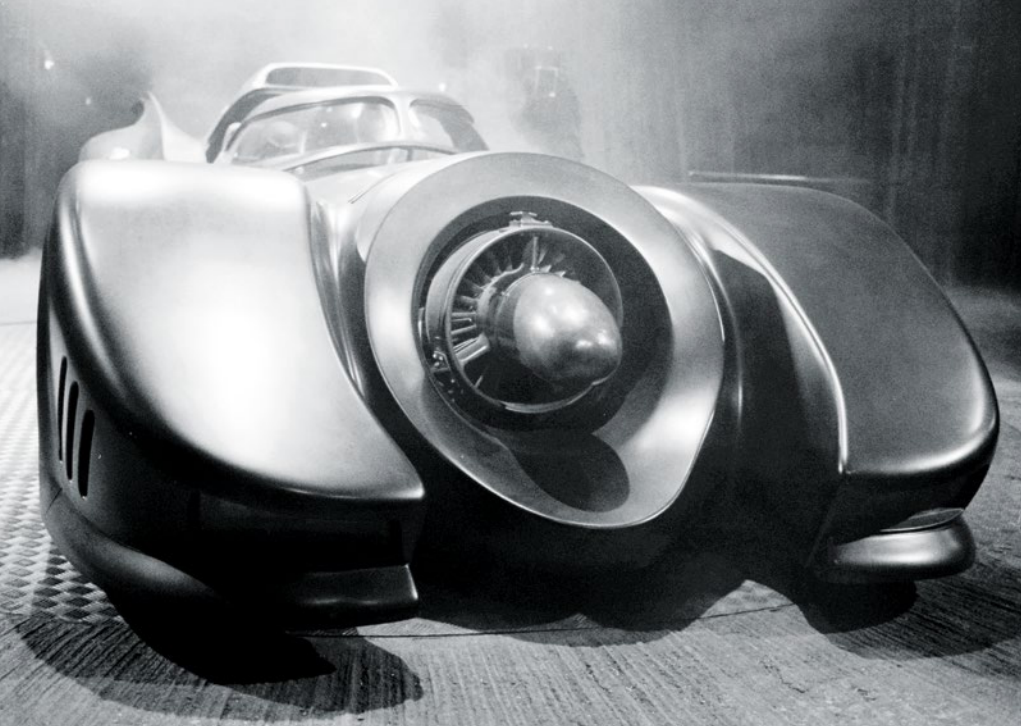

## LA FIDELIDAD A UNA VISIÓN

Los fans del universo de Batman™ estaban tan ansiosos como los críticos cinematográficos por contemplar la visión de Tim Burton sobre el Caballero Oscuro. Muchos temían que la película siguiera los cómicos pasos de la antigua serie para televisión. Pero Tim Burton, Anton Furst y un equipo de talentosos diseñadores de utilería y escenógrafos se mantuvieron firmes en su visión de traer de regreso la brutalidad y complejidad del universo de los cómics. Su representación del héroe original, creativa a la vez que fiel, puso definitivamente fin a todo temor.

El Batmobile™ se diseñó y construyó para recorrer y dominar las calles de GOTHAM CITY™, plagadas de delincuencia. Símbolo de orden y justicia en medio del caos, puede confundirse con las sombras, listo para entrar en acción en el momento en que los ciudadanos se encuentren en peligro.

Su elegante y agresivo exterior se logró con piezas e ideas basadas en autos modernos y clásicos, así como en aviones de combate. El resultado: un torpedo de vehículo con suficiente potencia como para proteger a su héroe, salvar a la ocasional damisela en apuros y, por supuesto, detener a los villanos.

Es el perfecto representante de un mundo que todavía nos invita a explorar nuestra propia oscuridad, despierta nuestra curiosidad y creatividad, y saca a relucir nuestros instintos heroicos.





**... Y AHORA TENGO QUE IRME A TRABAJAR™**

**– Bruce Wayne™**

Con 24 bolsas y un total de 3,5 kg de bricks (casi 3300 piezas), es momento de construir tu propia muestra del universo de Batman™ y dejar que tome el lugar que le corresponde en tu colección de objetos memorables, sala, oficina o Batcave™.

---



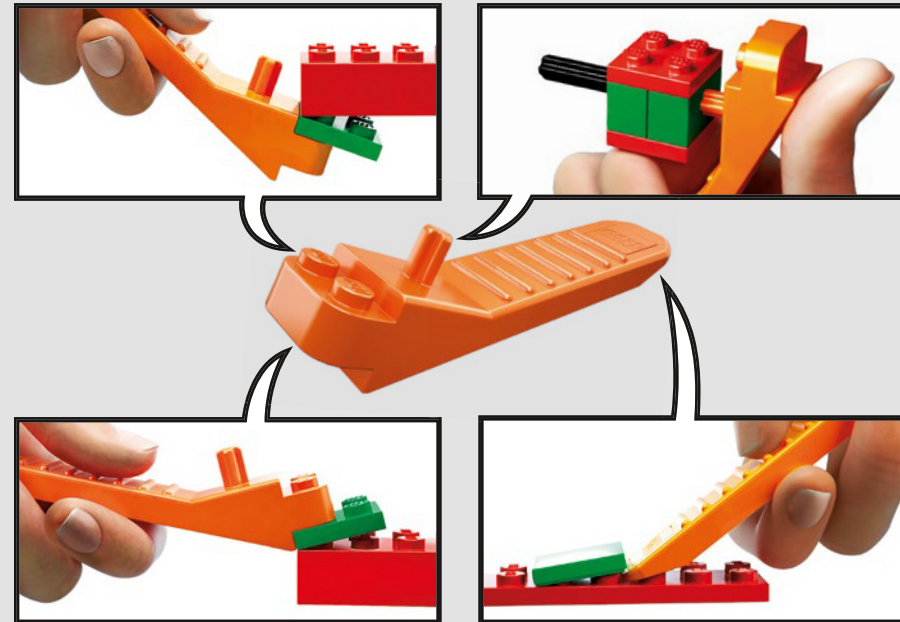

[LEGO.com/brickseparator](https://LEGO.com/brickseparator)

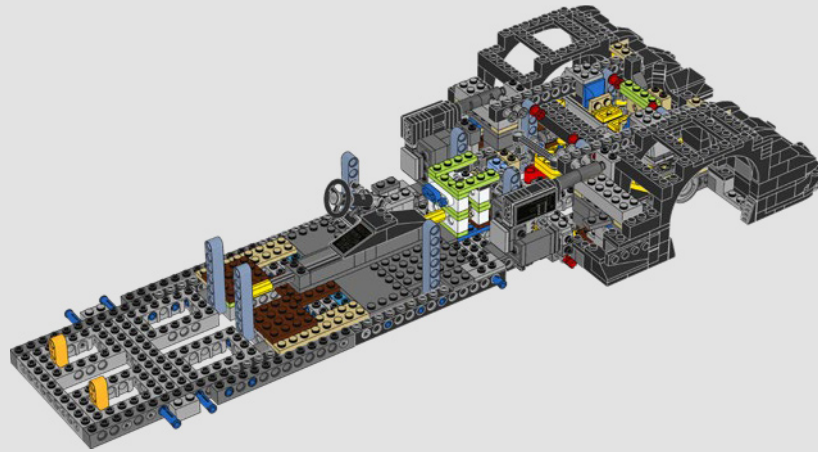
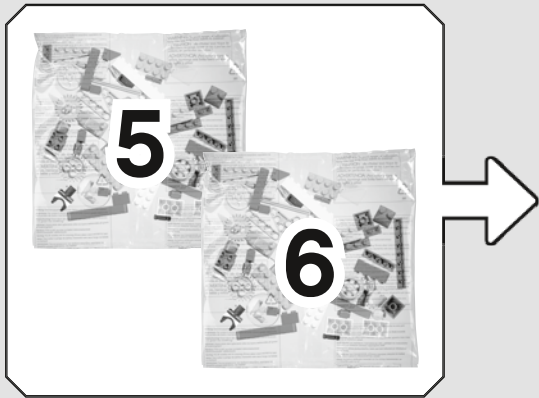
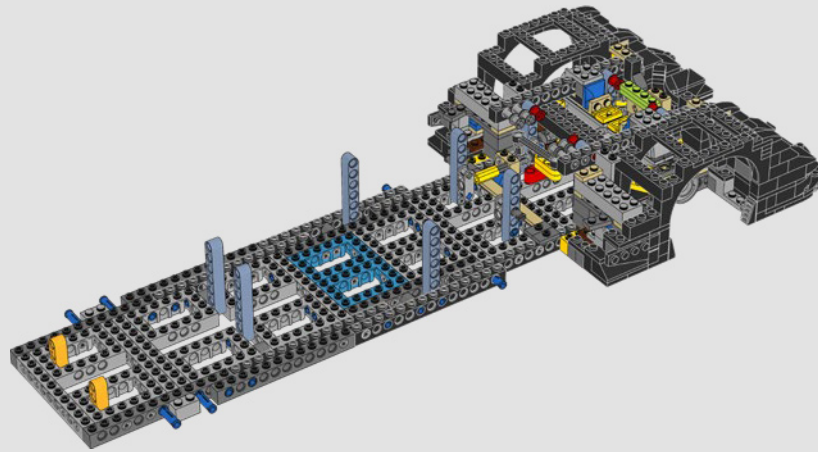
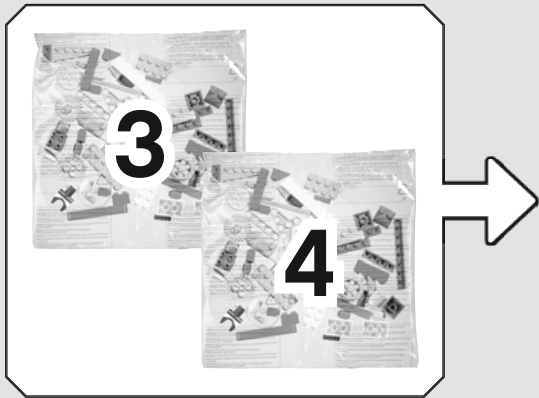
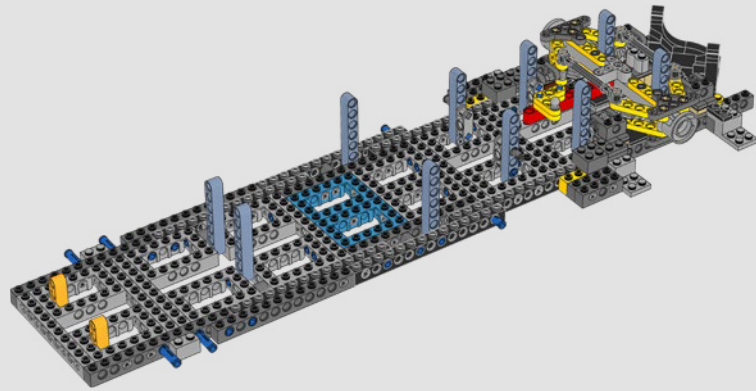
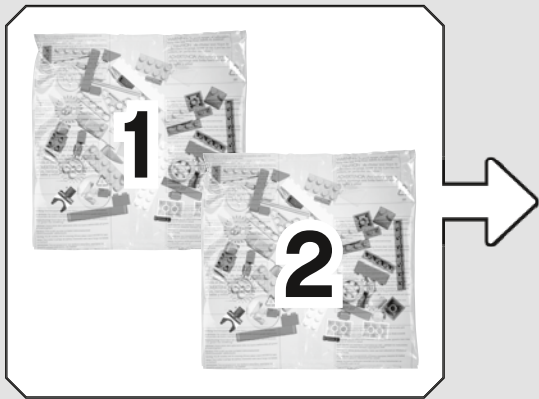

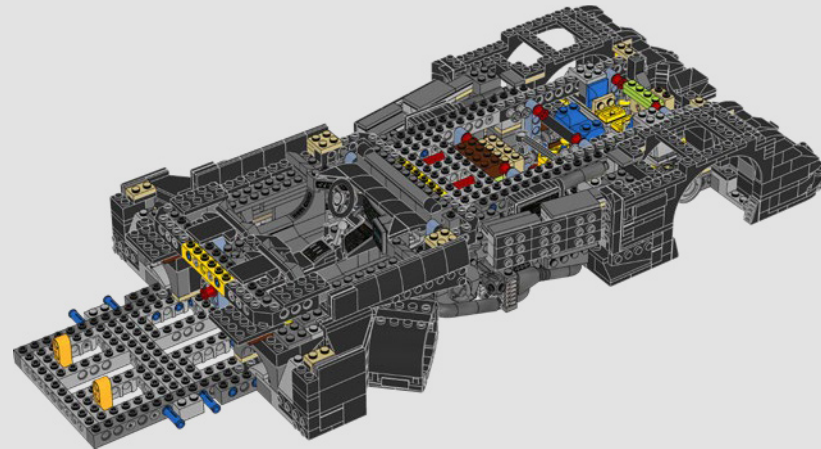
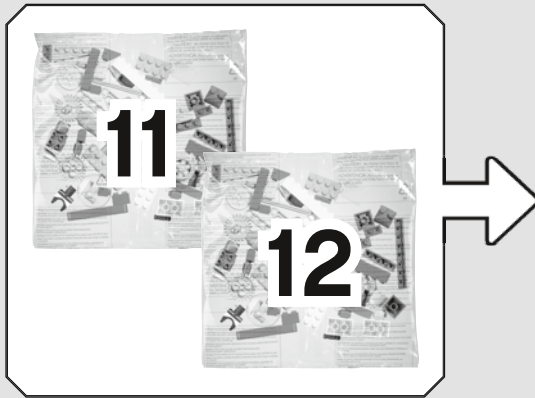
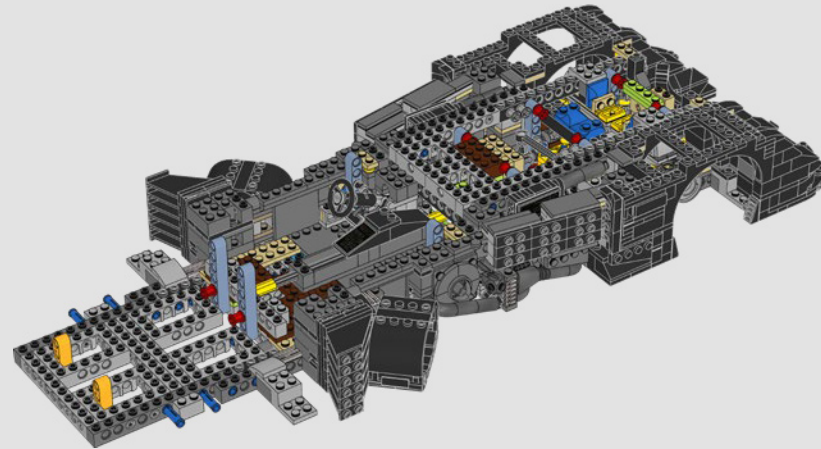
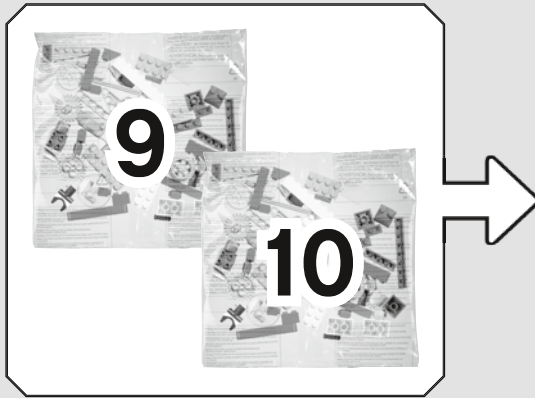
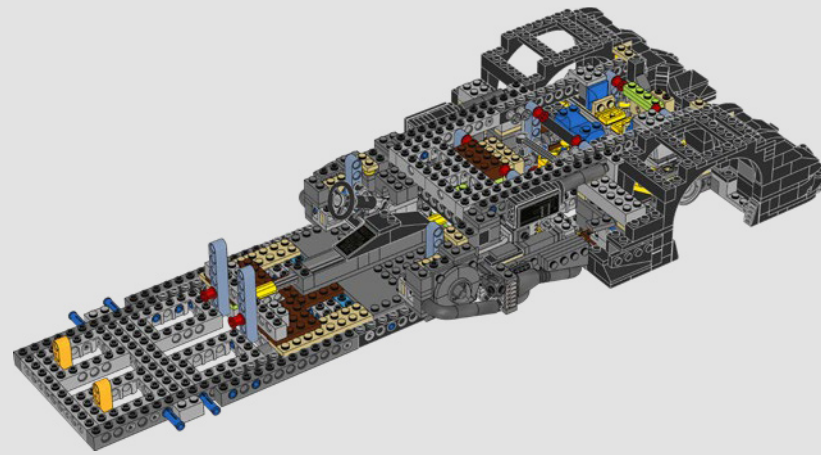
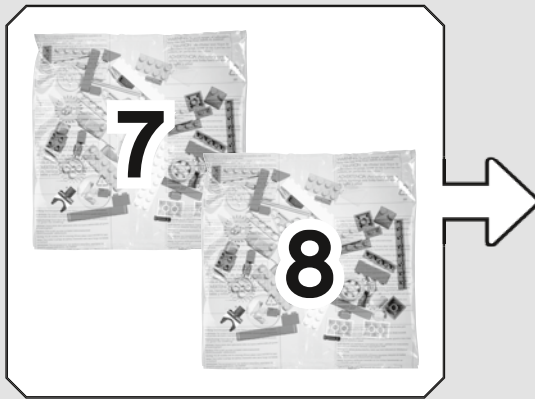

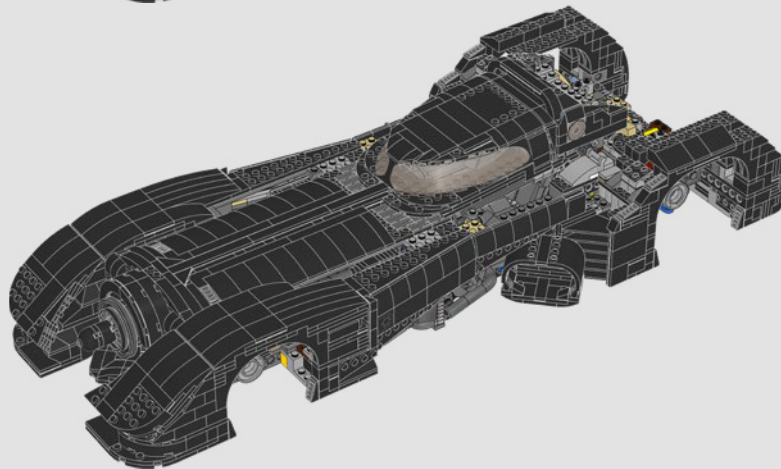
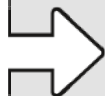
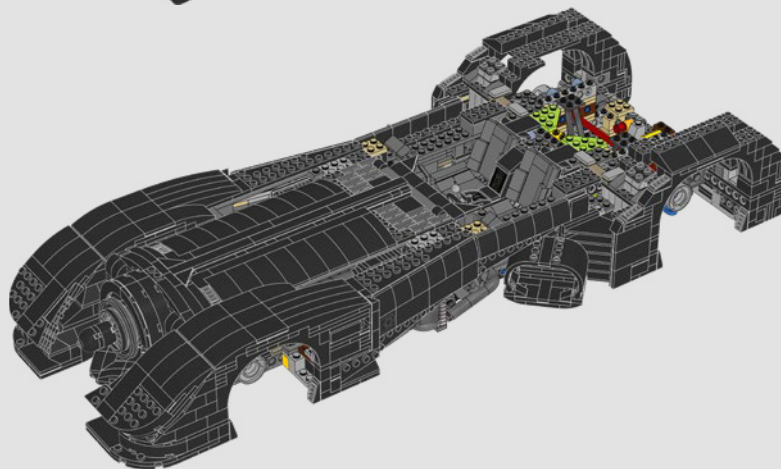
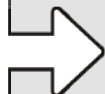
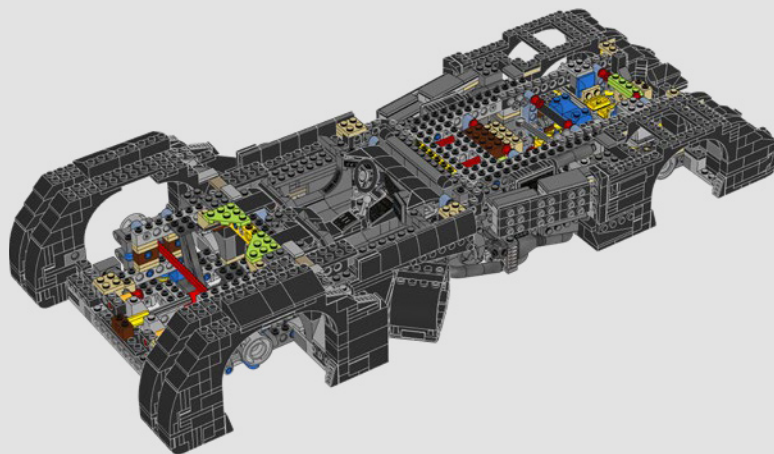
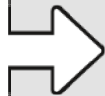

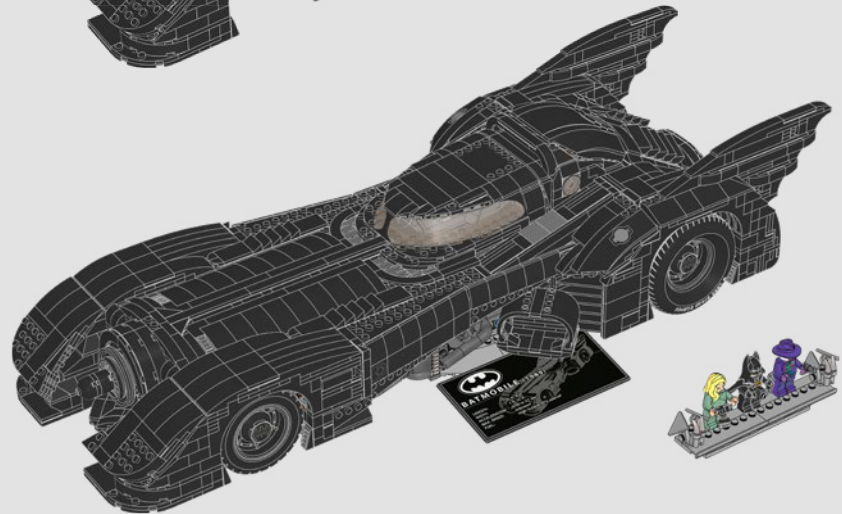
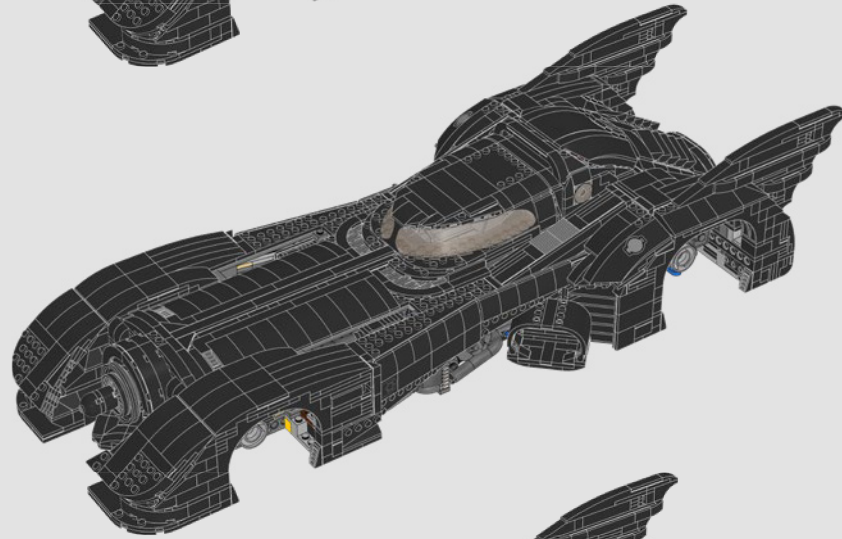
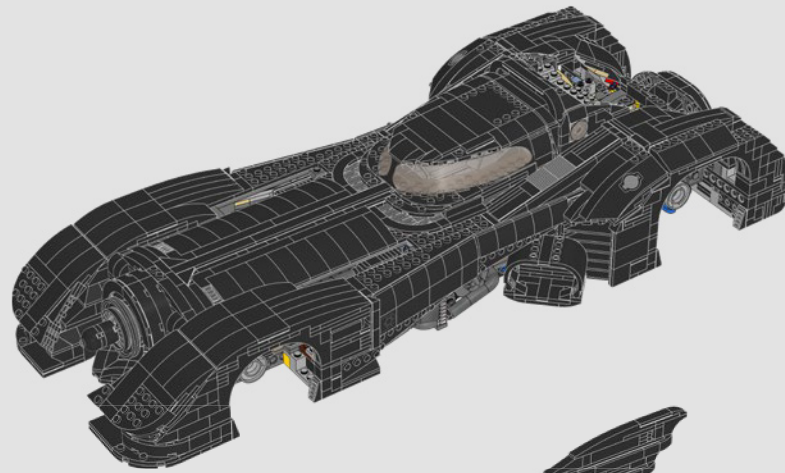

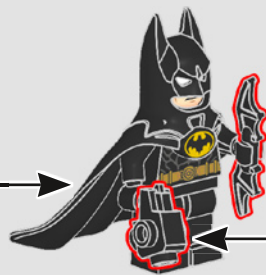
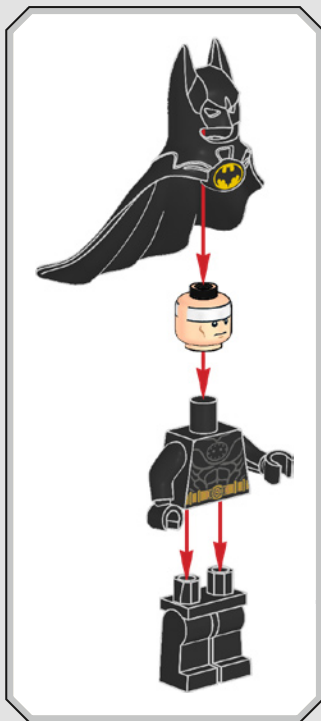
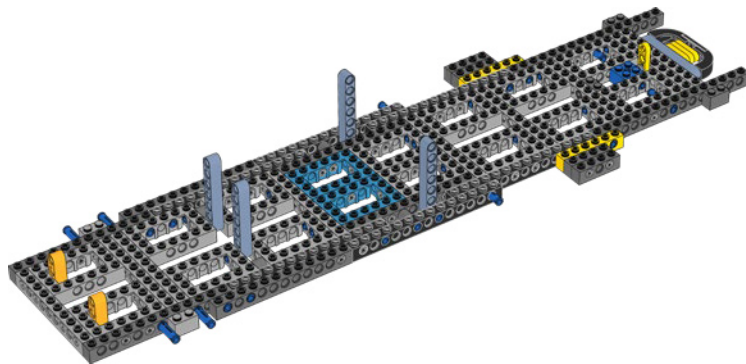
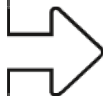
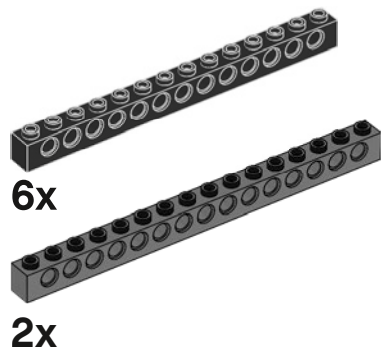



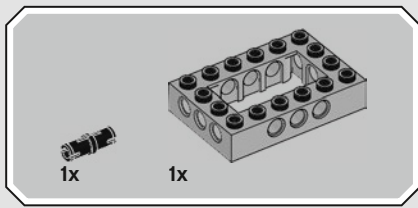

1

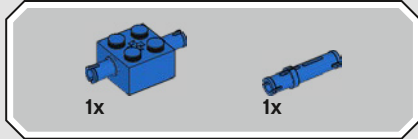
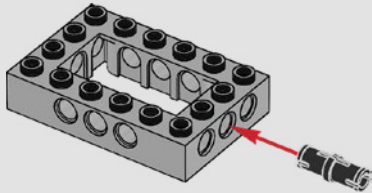

2

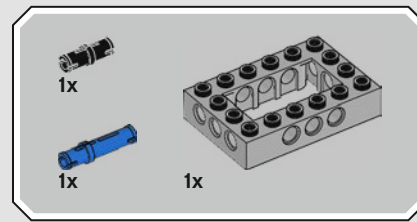
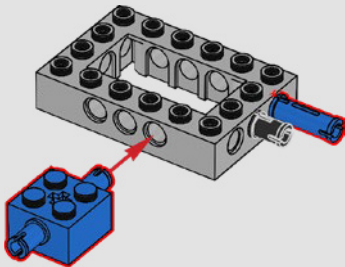

3

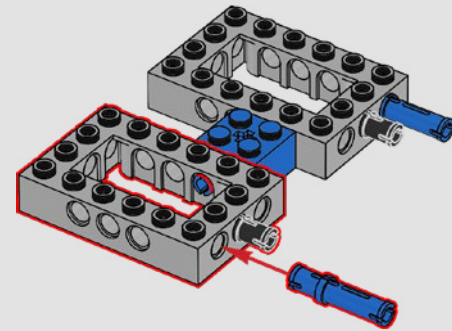

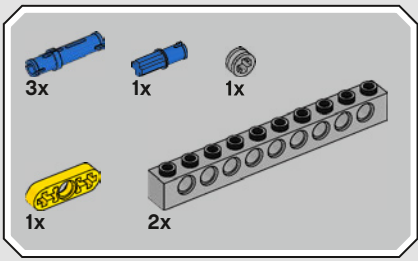

4

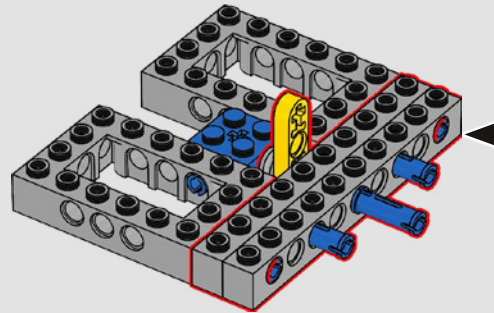
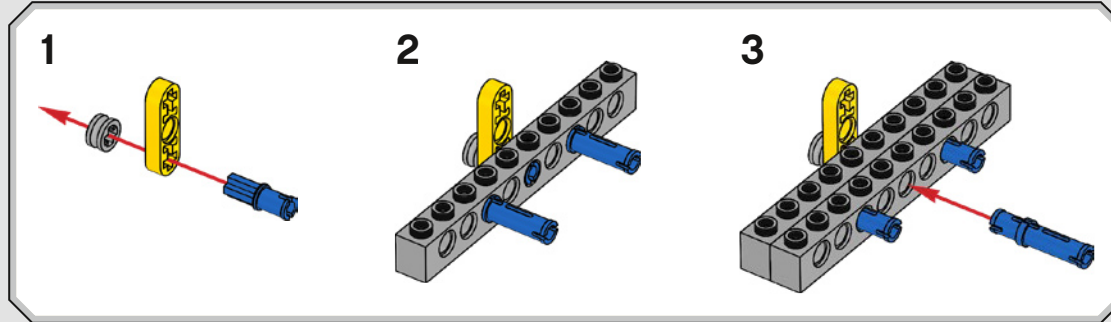

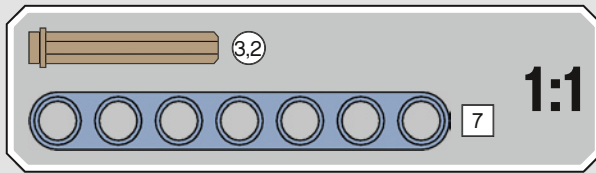
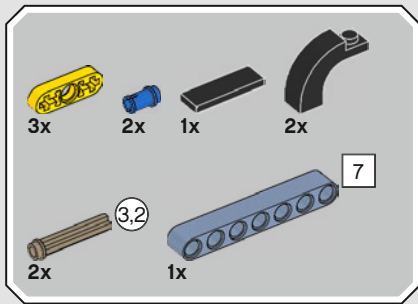

5

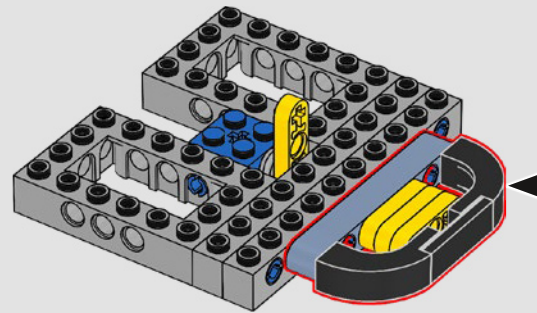
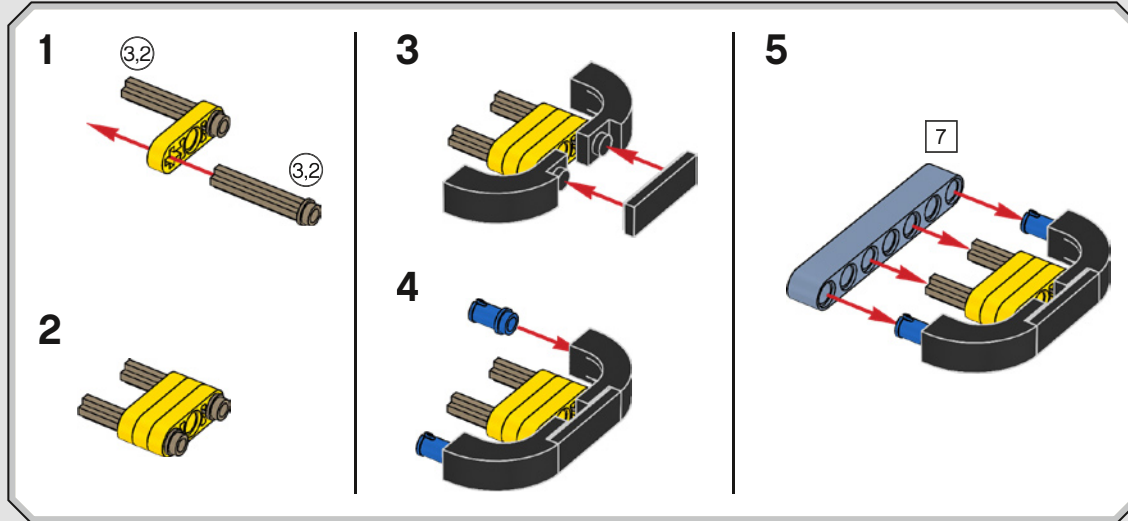

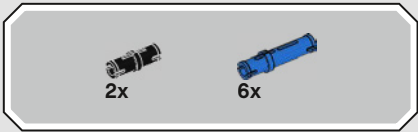

6

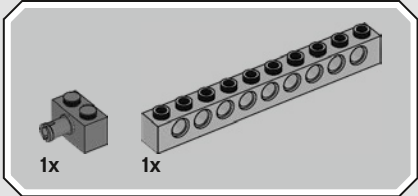
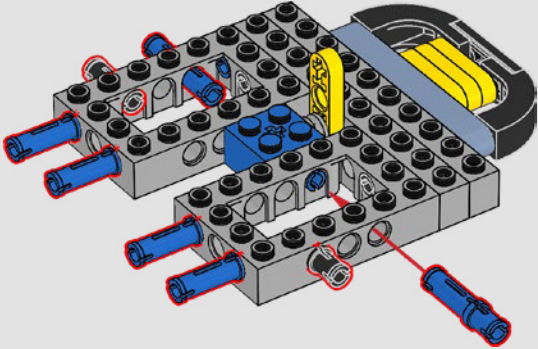

7

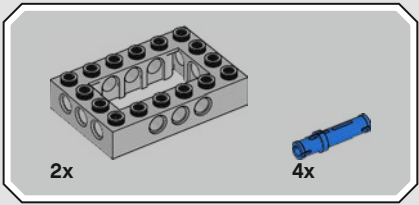
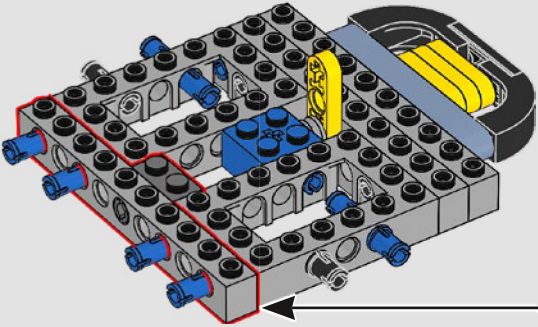
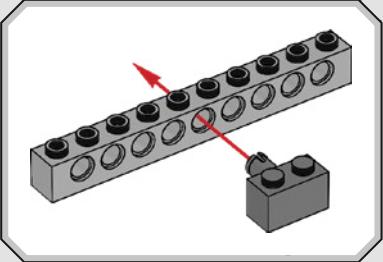

8

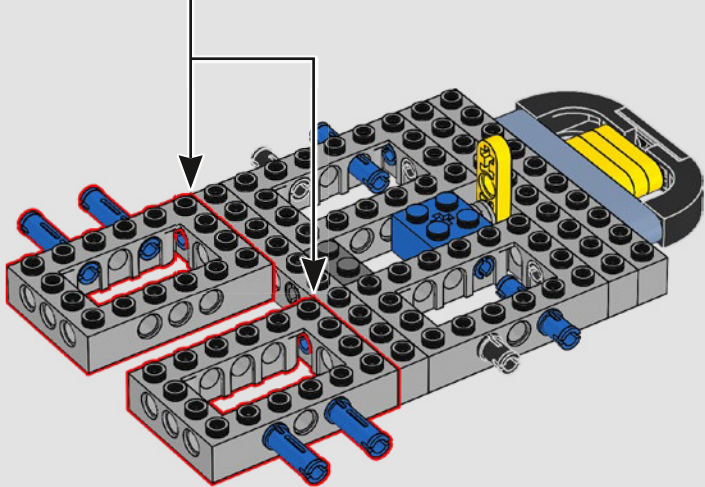
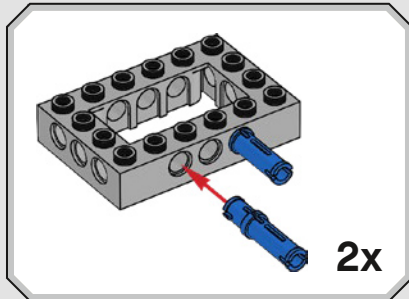

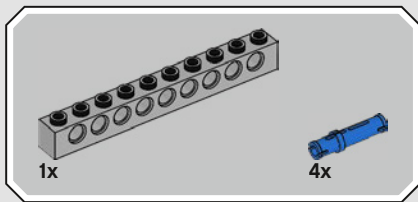

9

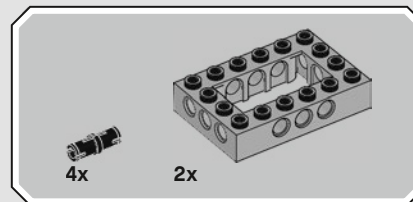
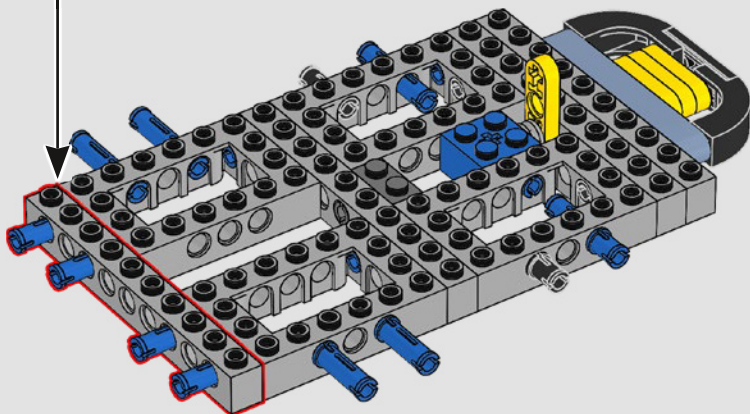
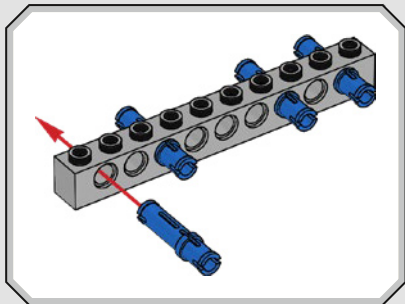

10

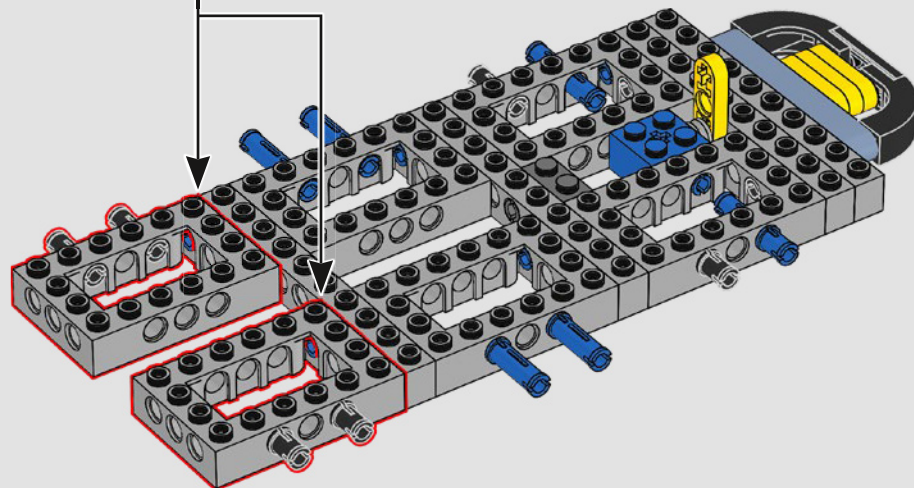
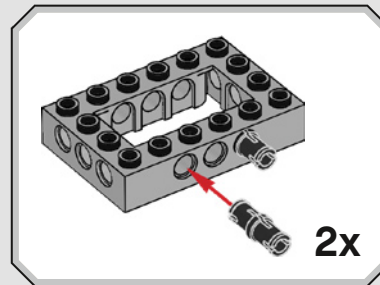

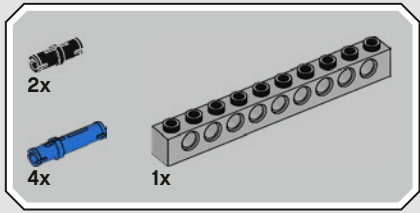

11

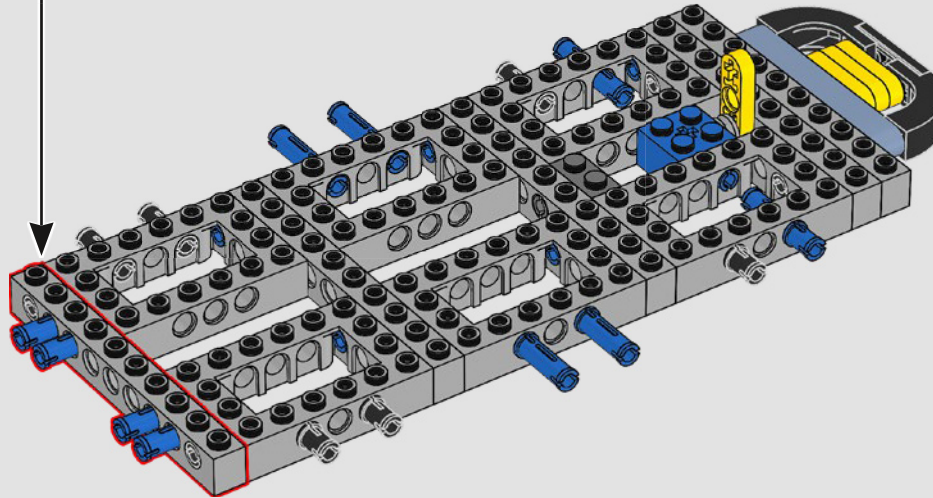
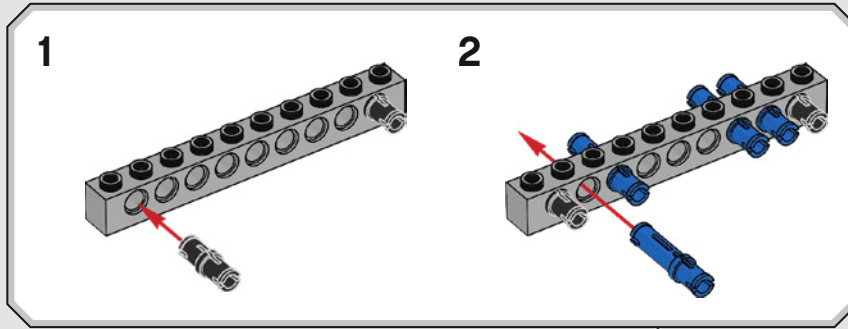

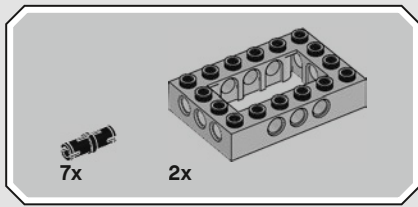

12

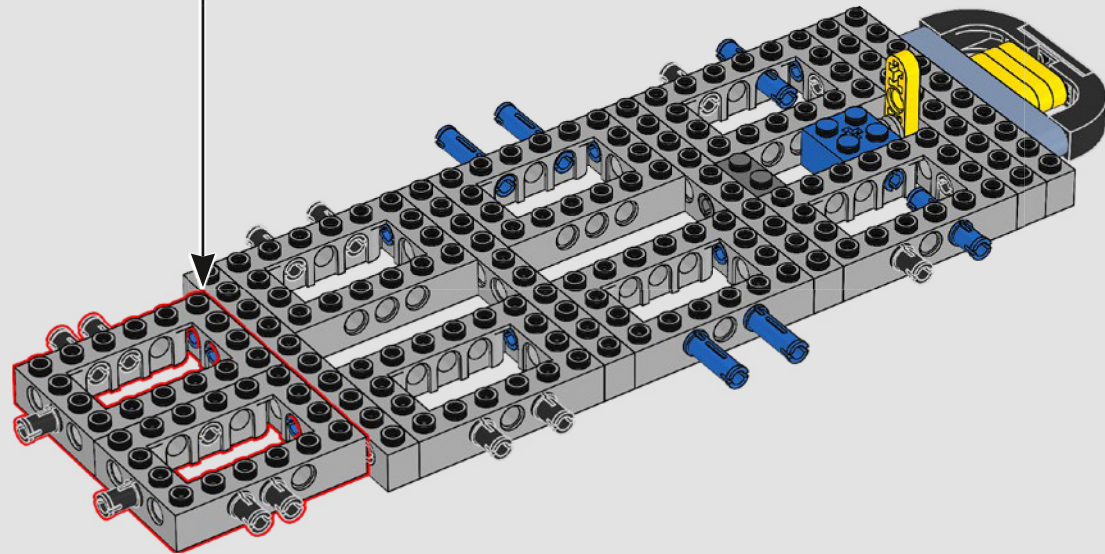
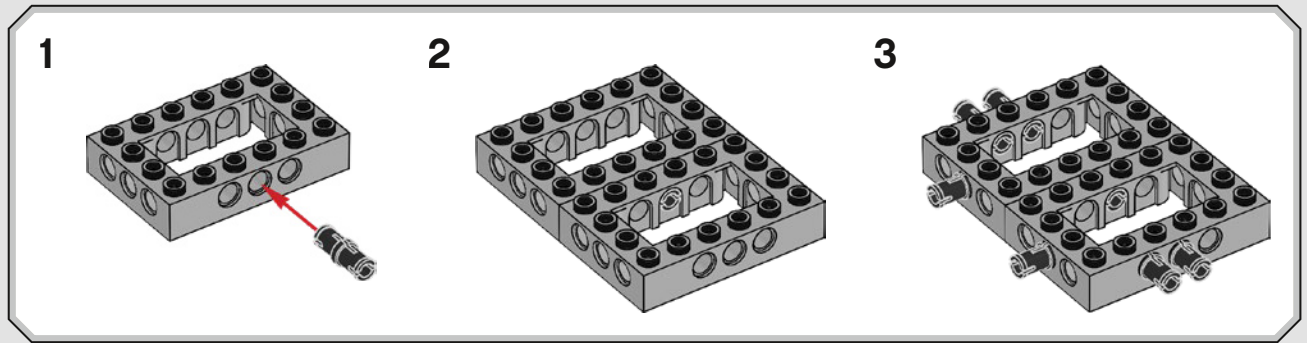

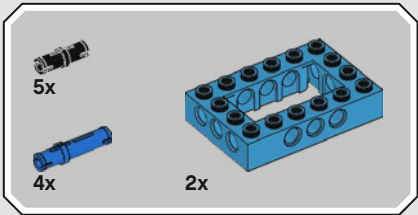

13

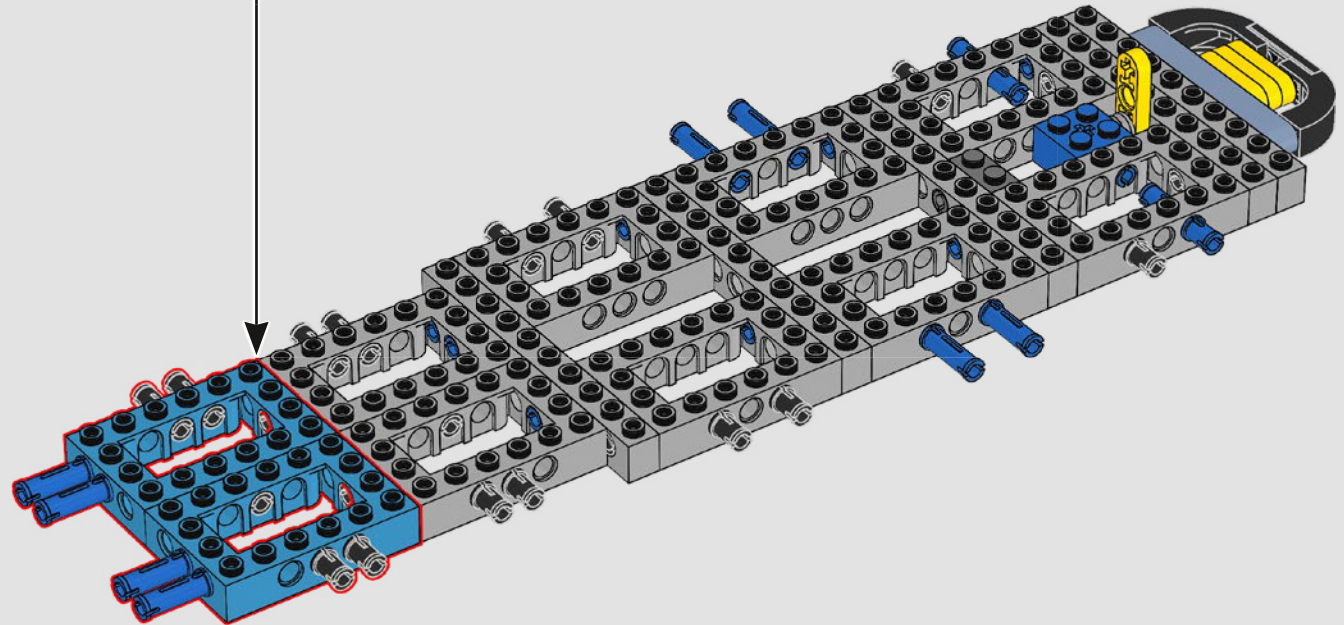
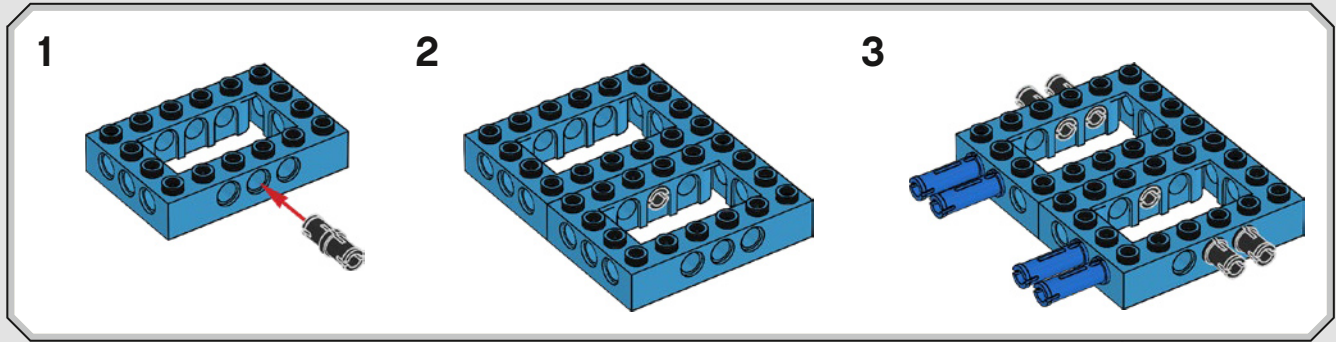



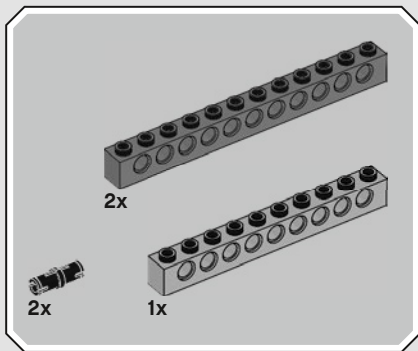

14

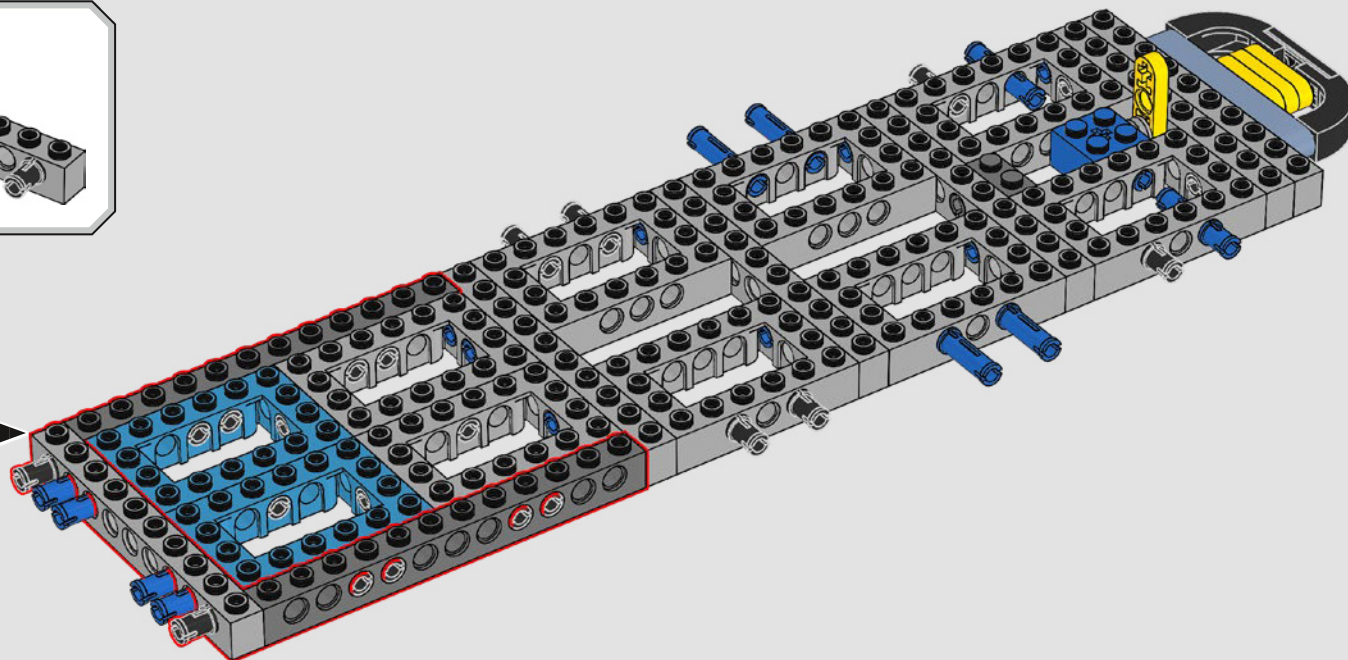
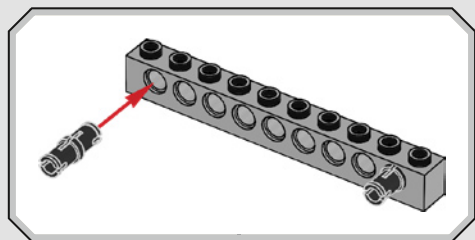

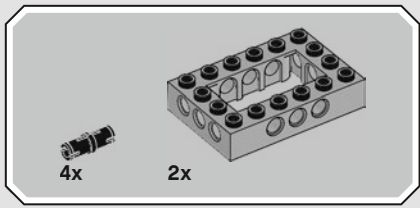

15

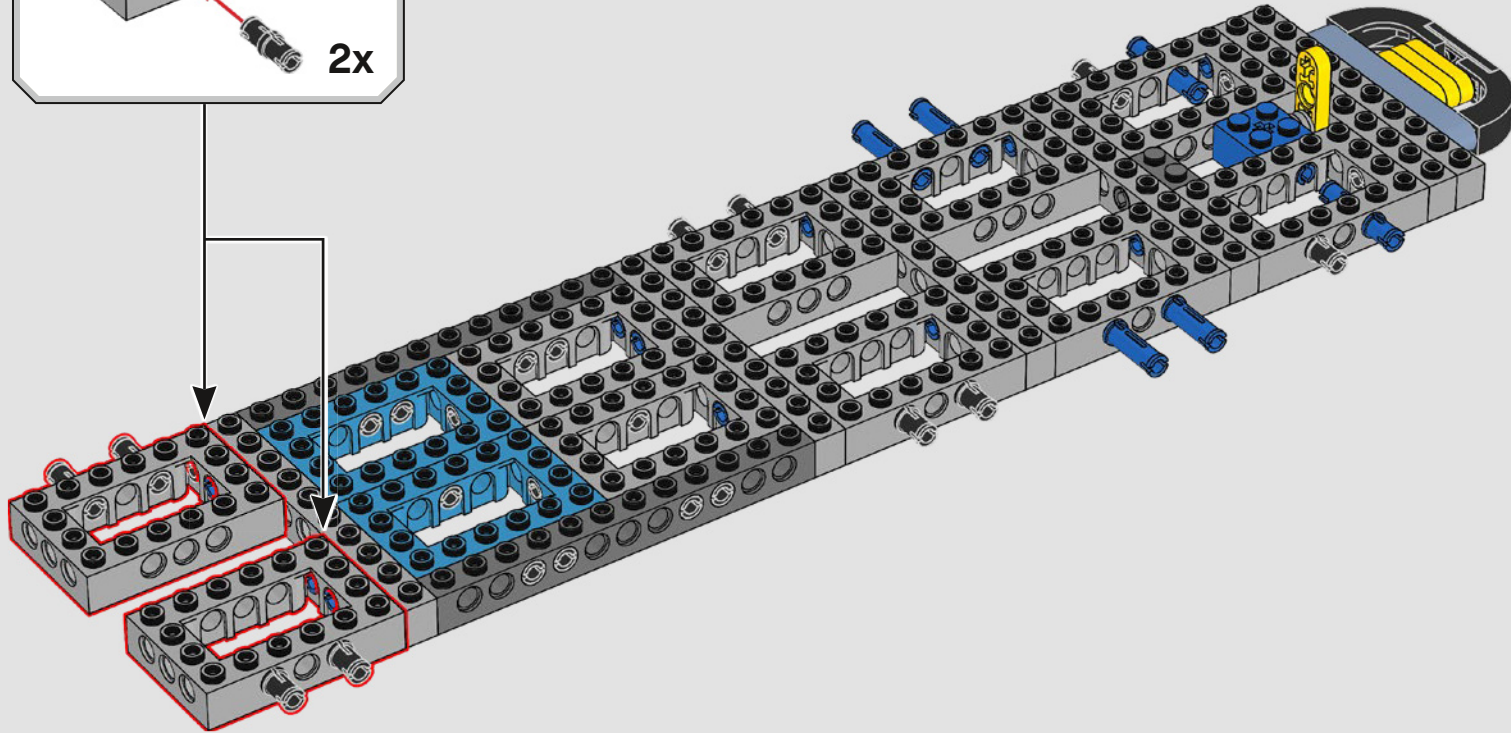
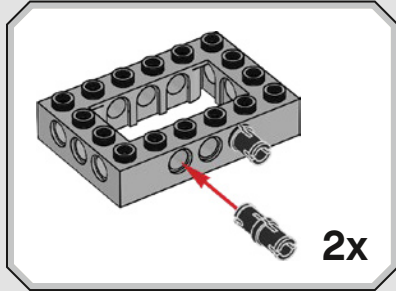

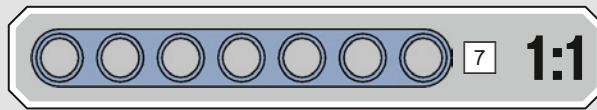
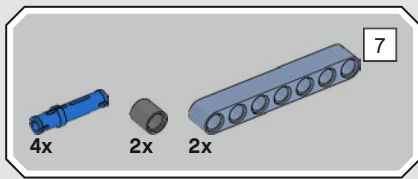

16

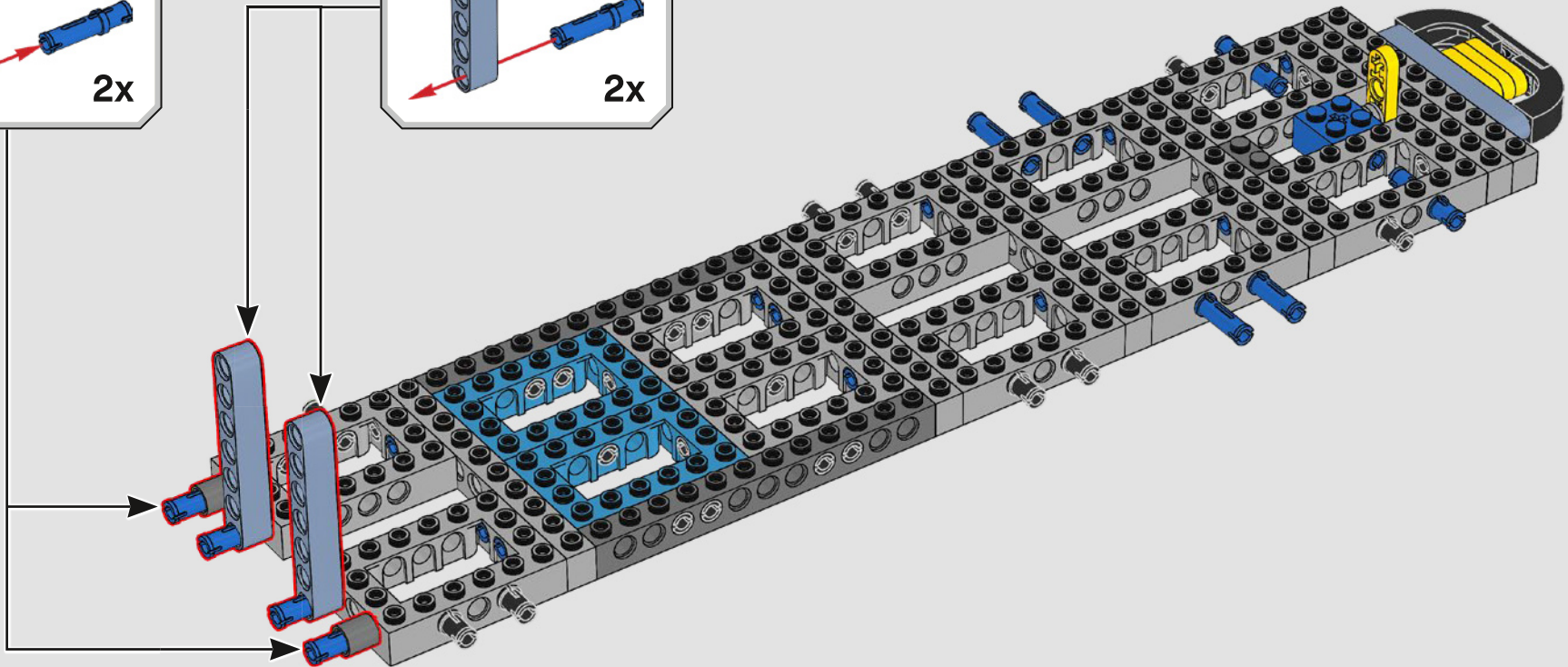
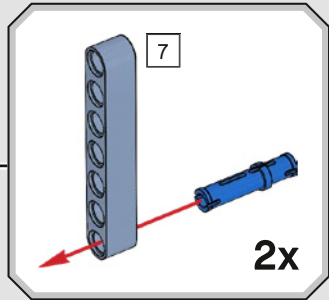
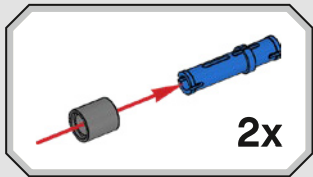

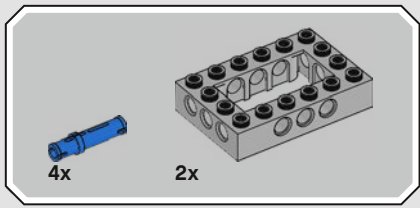

17

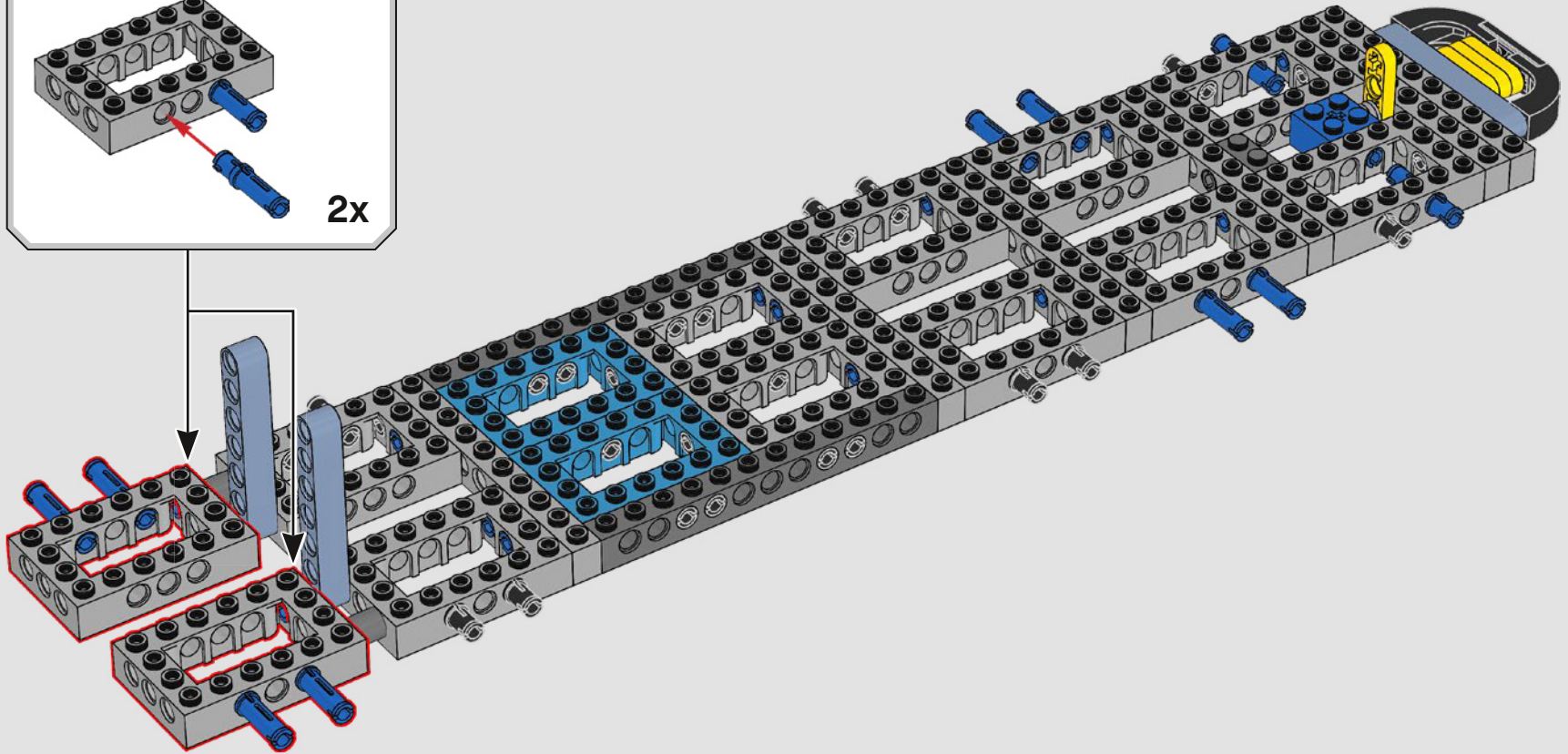
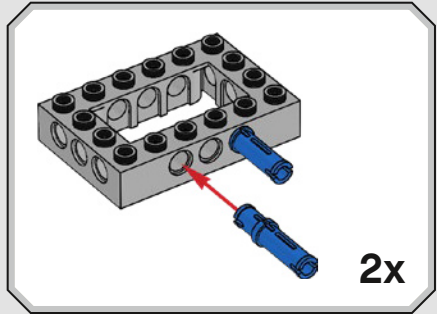

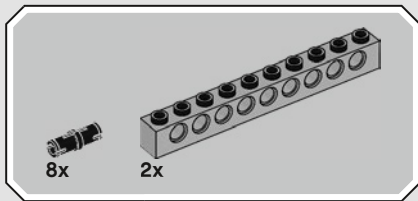

18

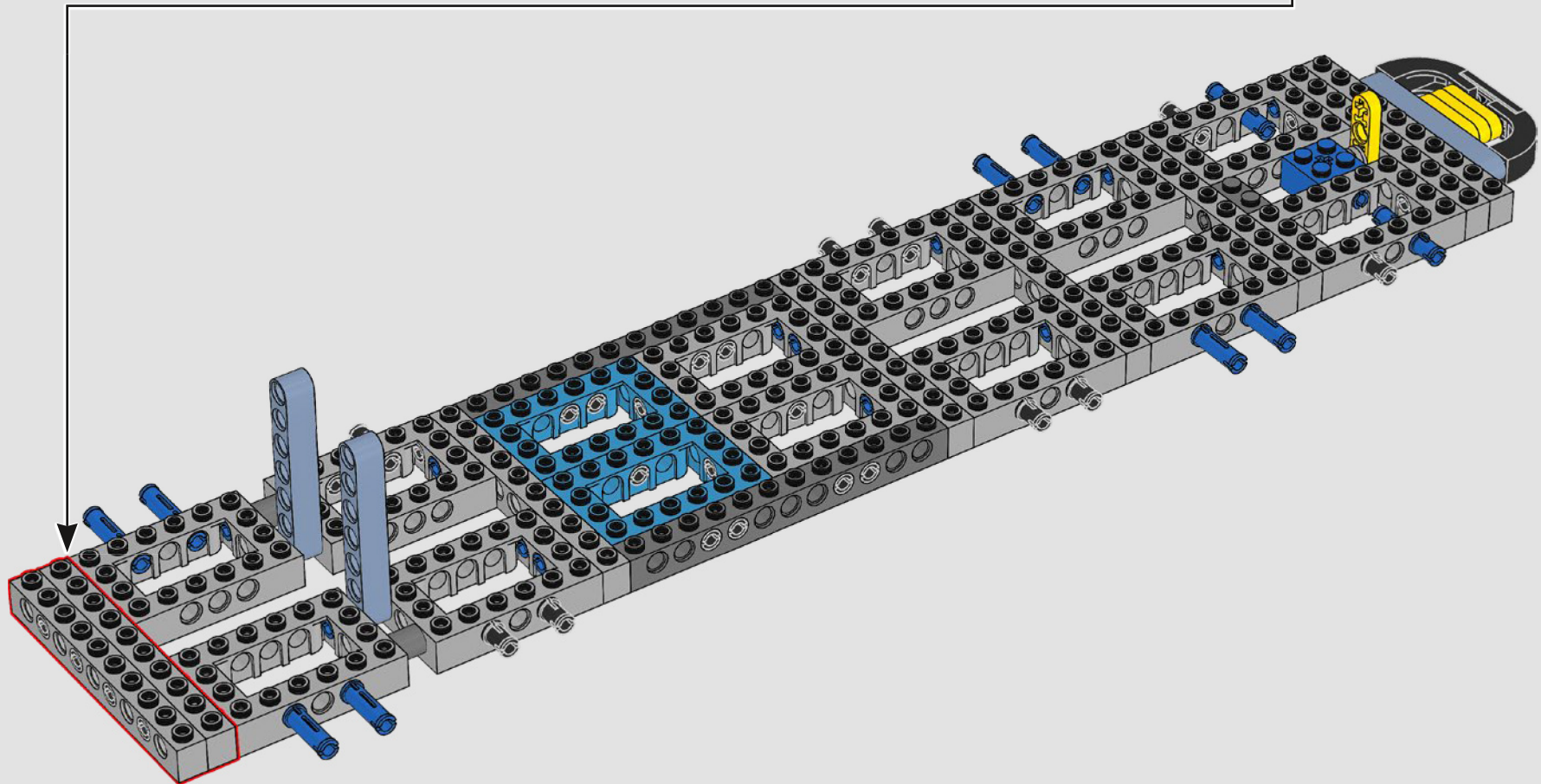
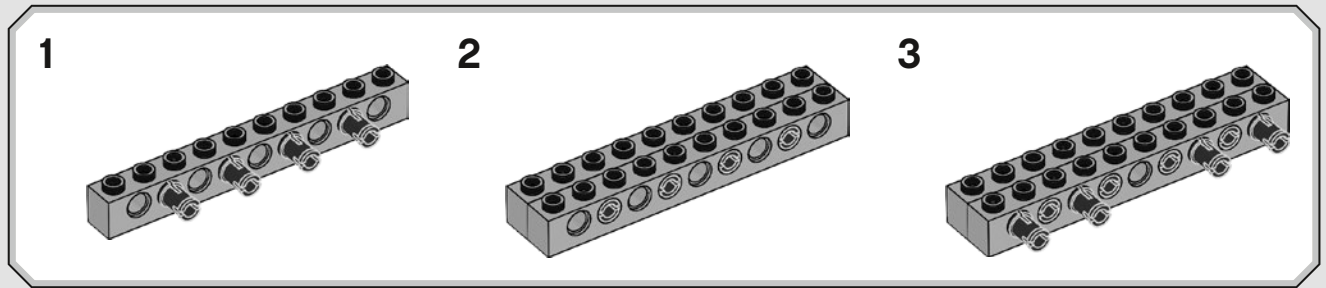

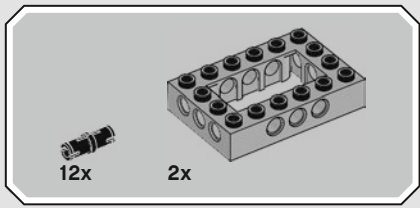

19

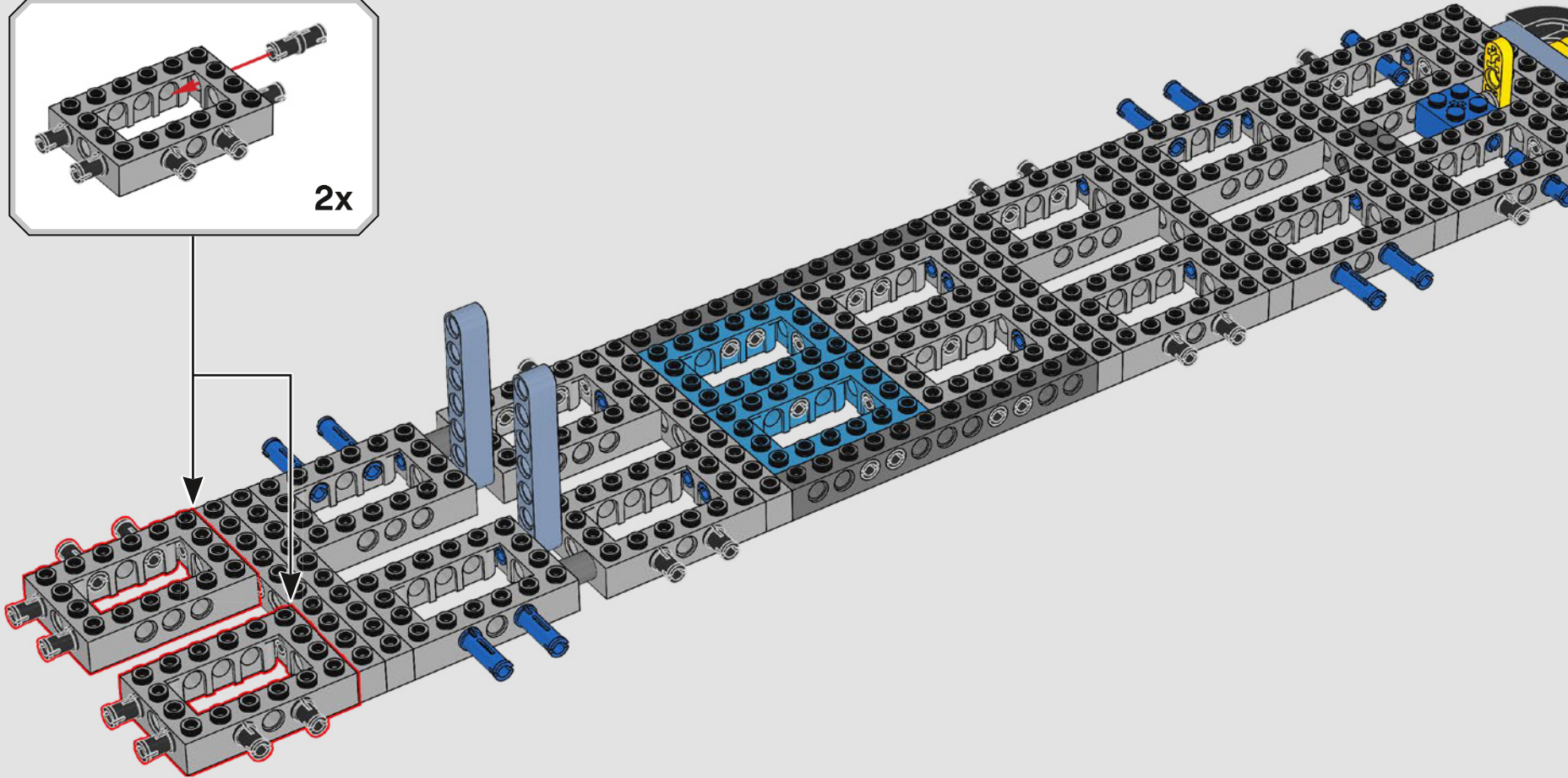
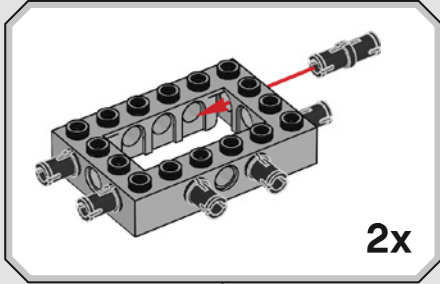

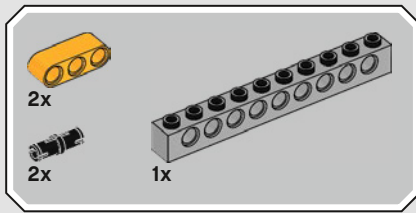

20

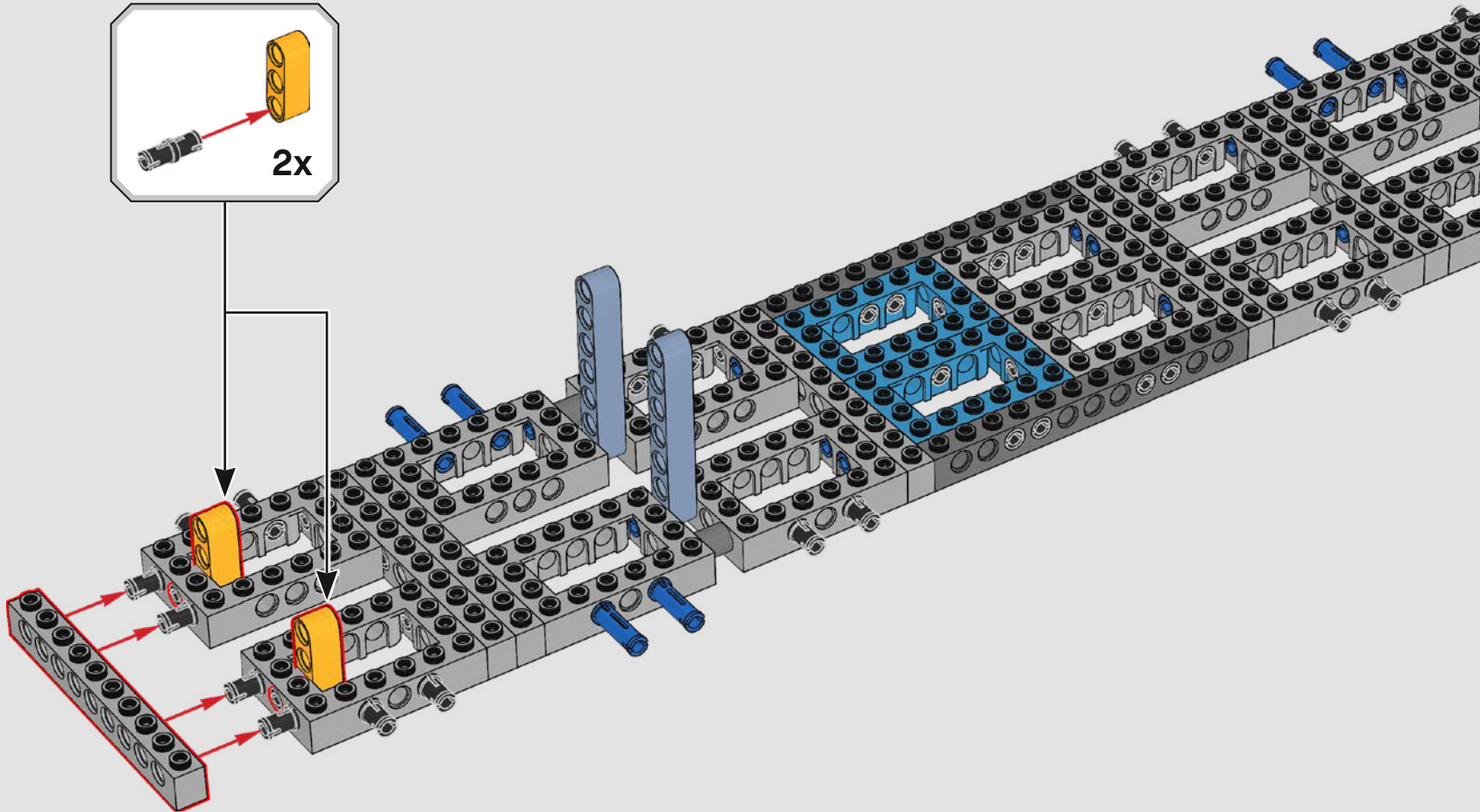
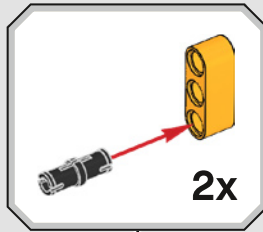

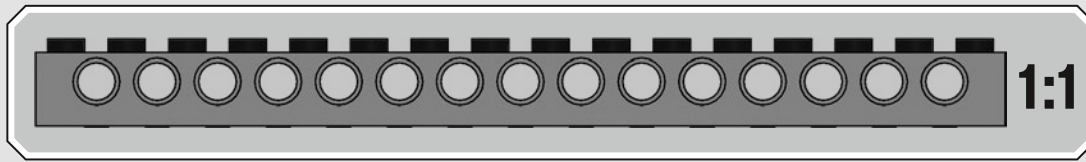
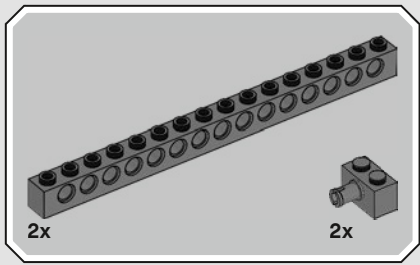

21

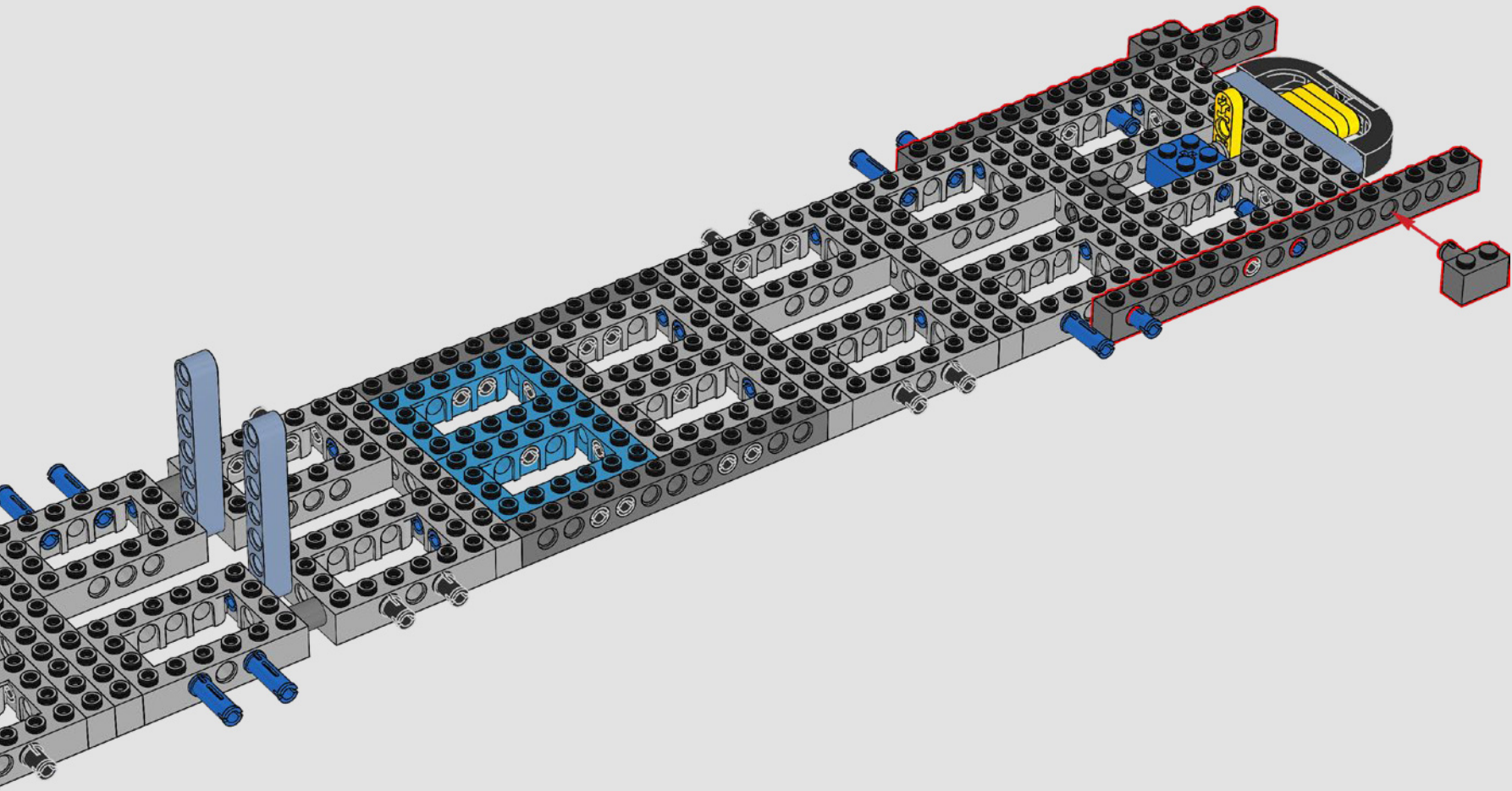



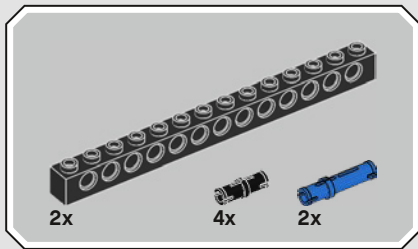

22

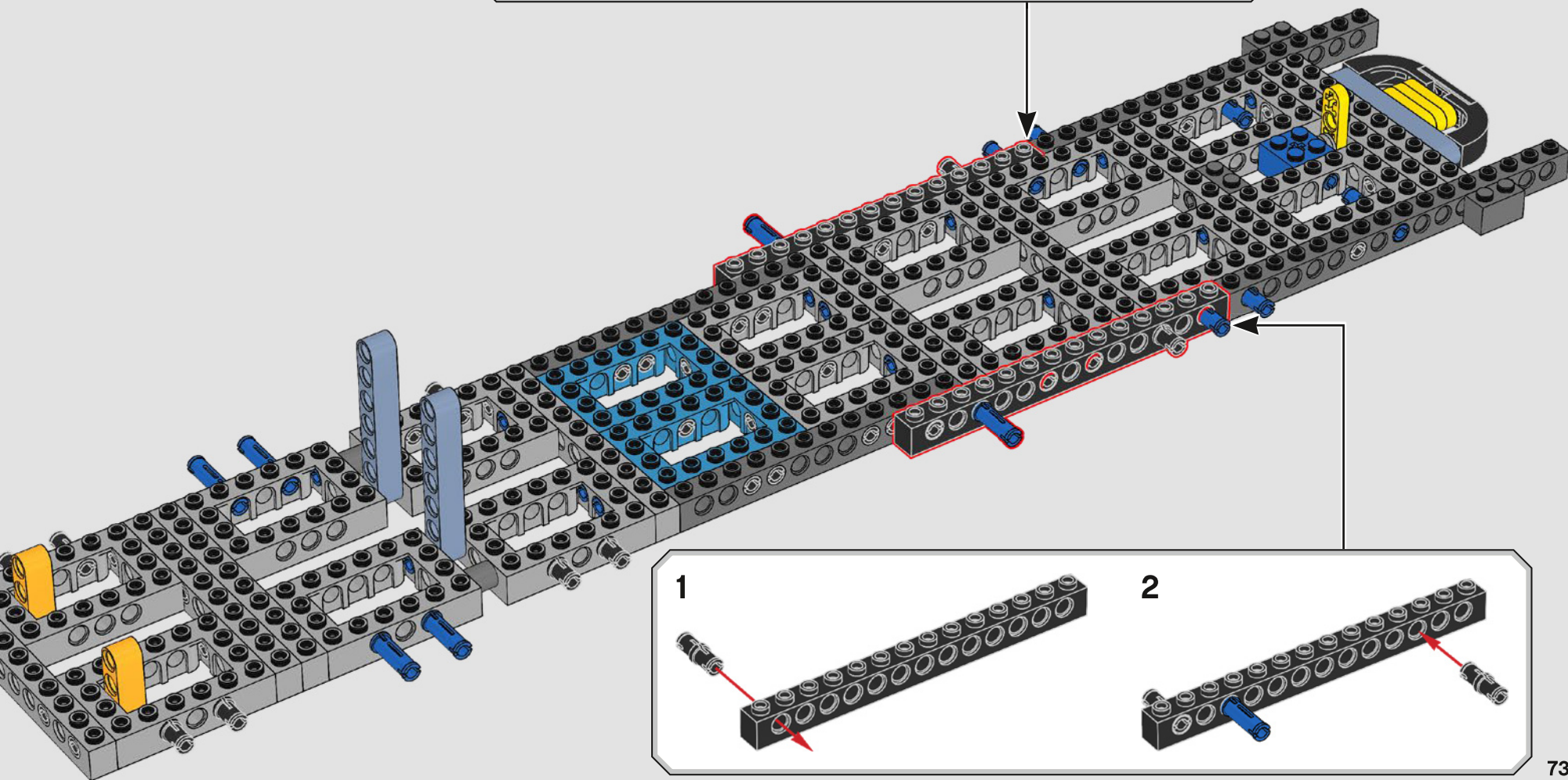
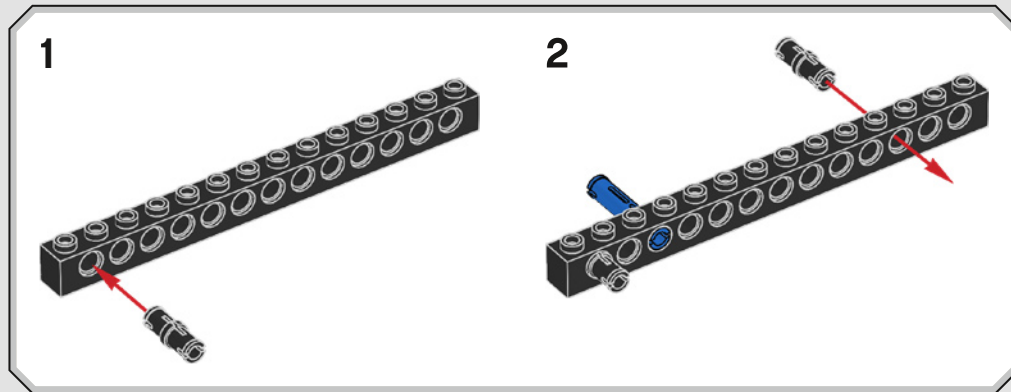

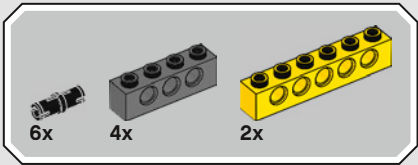

23

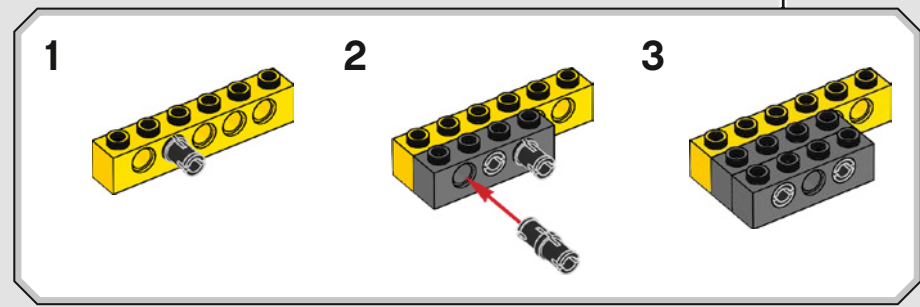
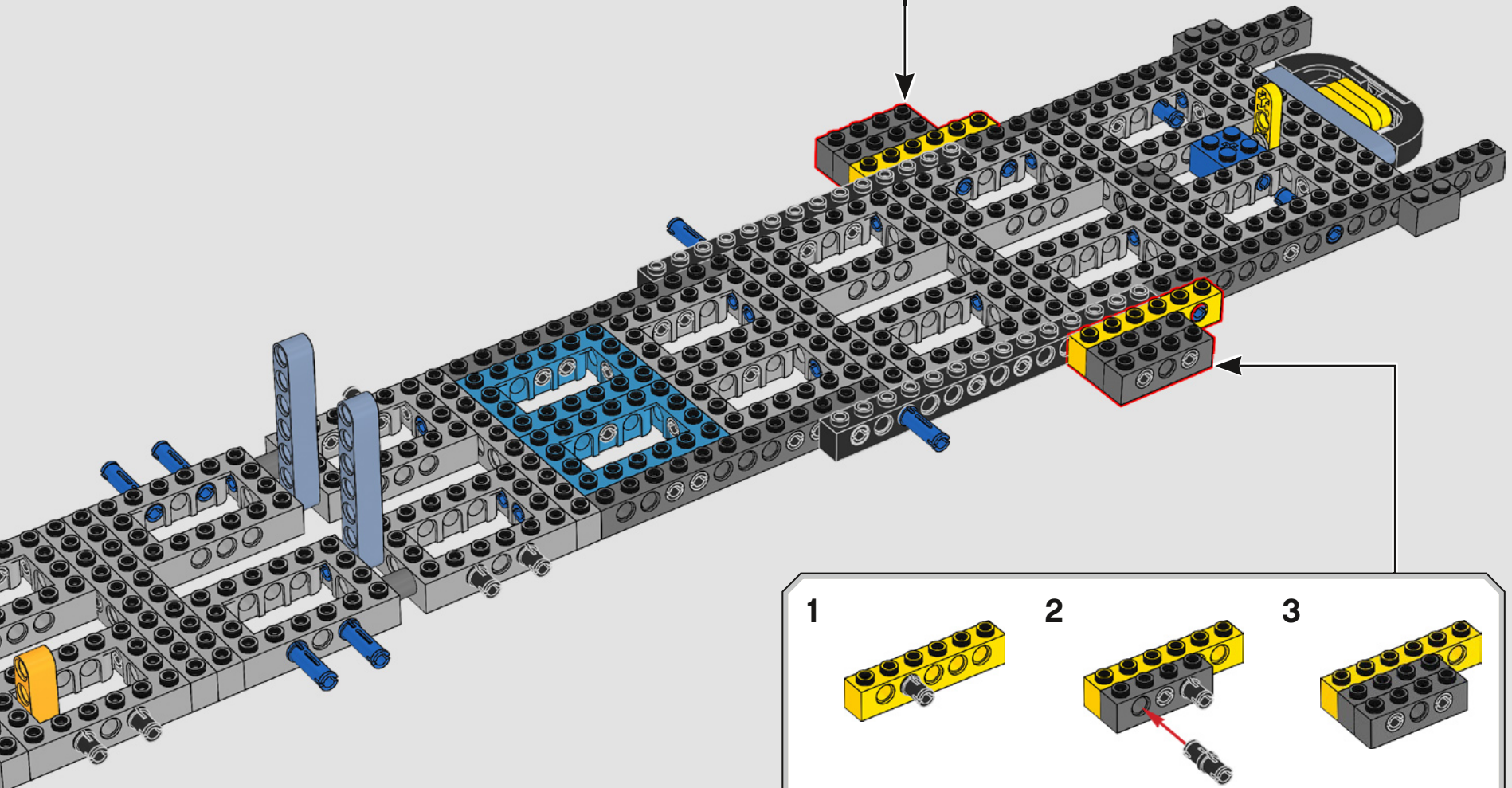
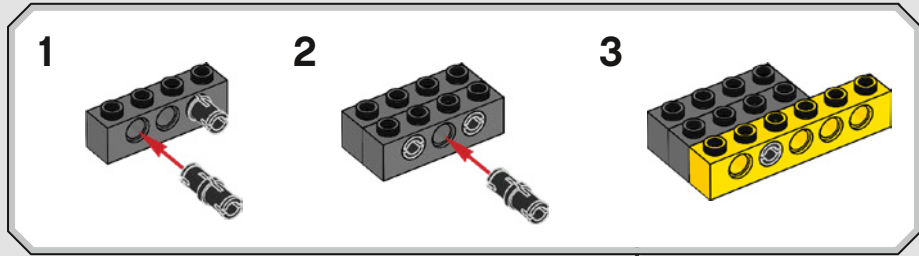

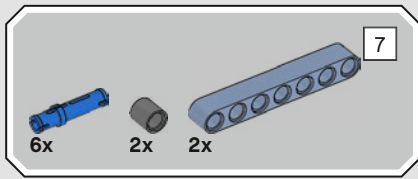

24

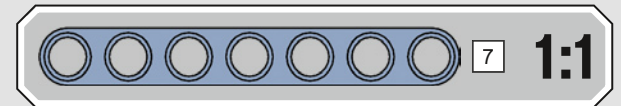
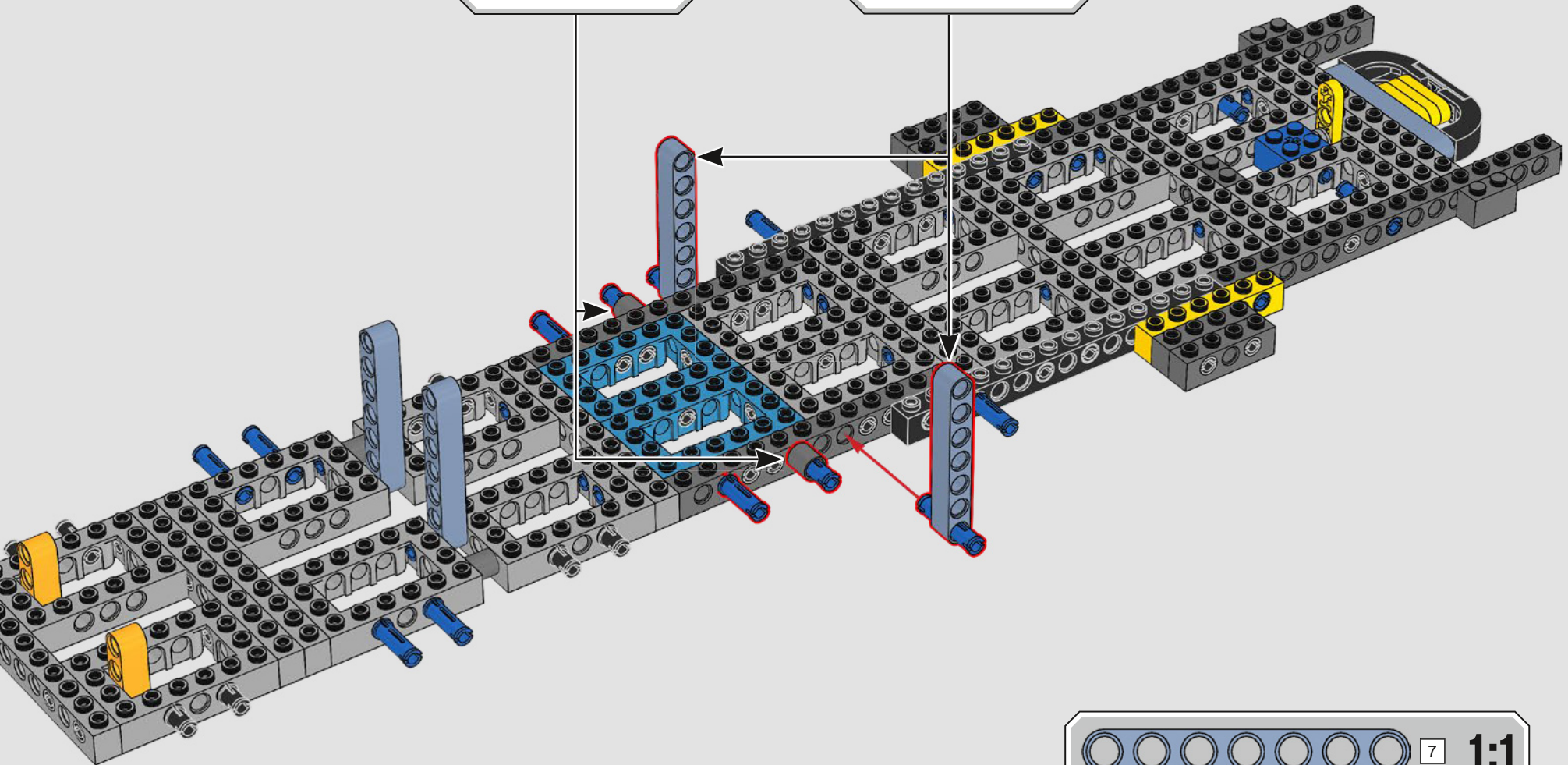
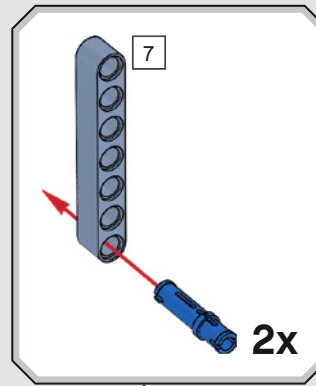
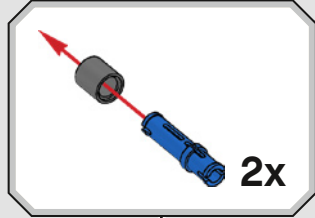

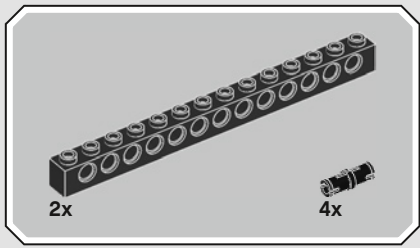

25

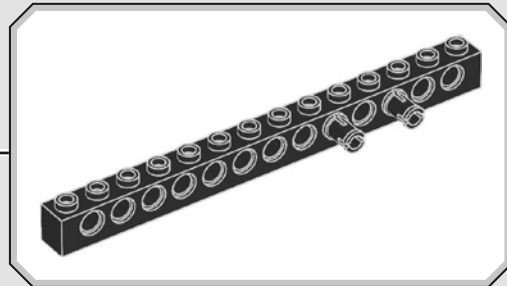
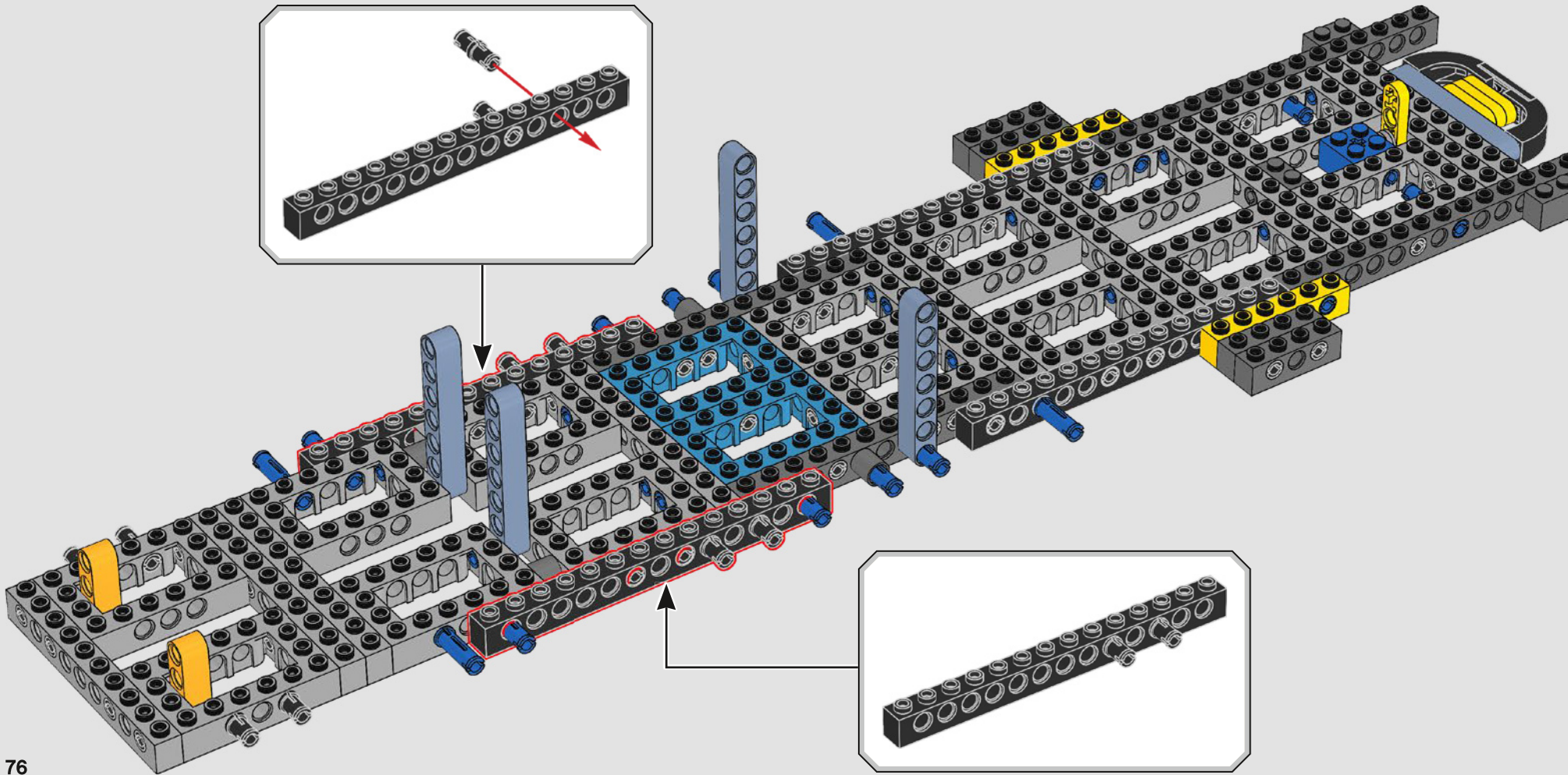
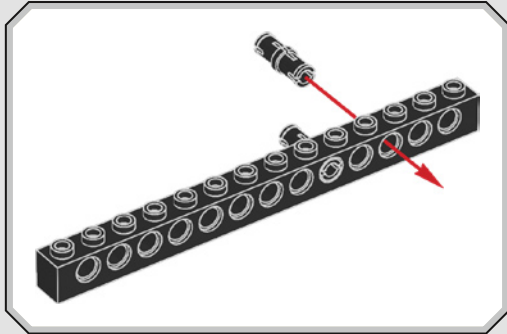

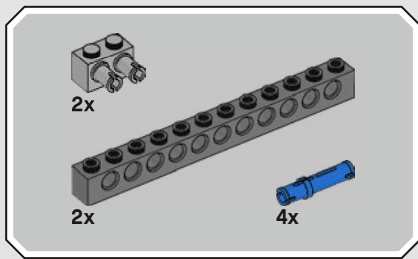

26

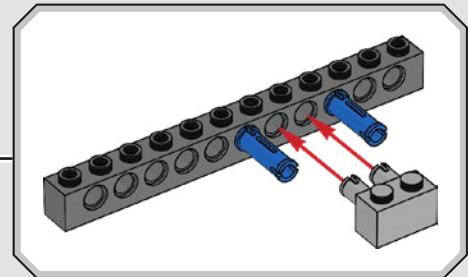
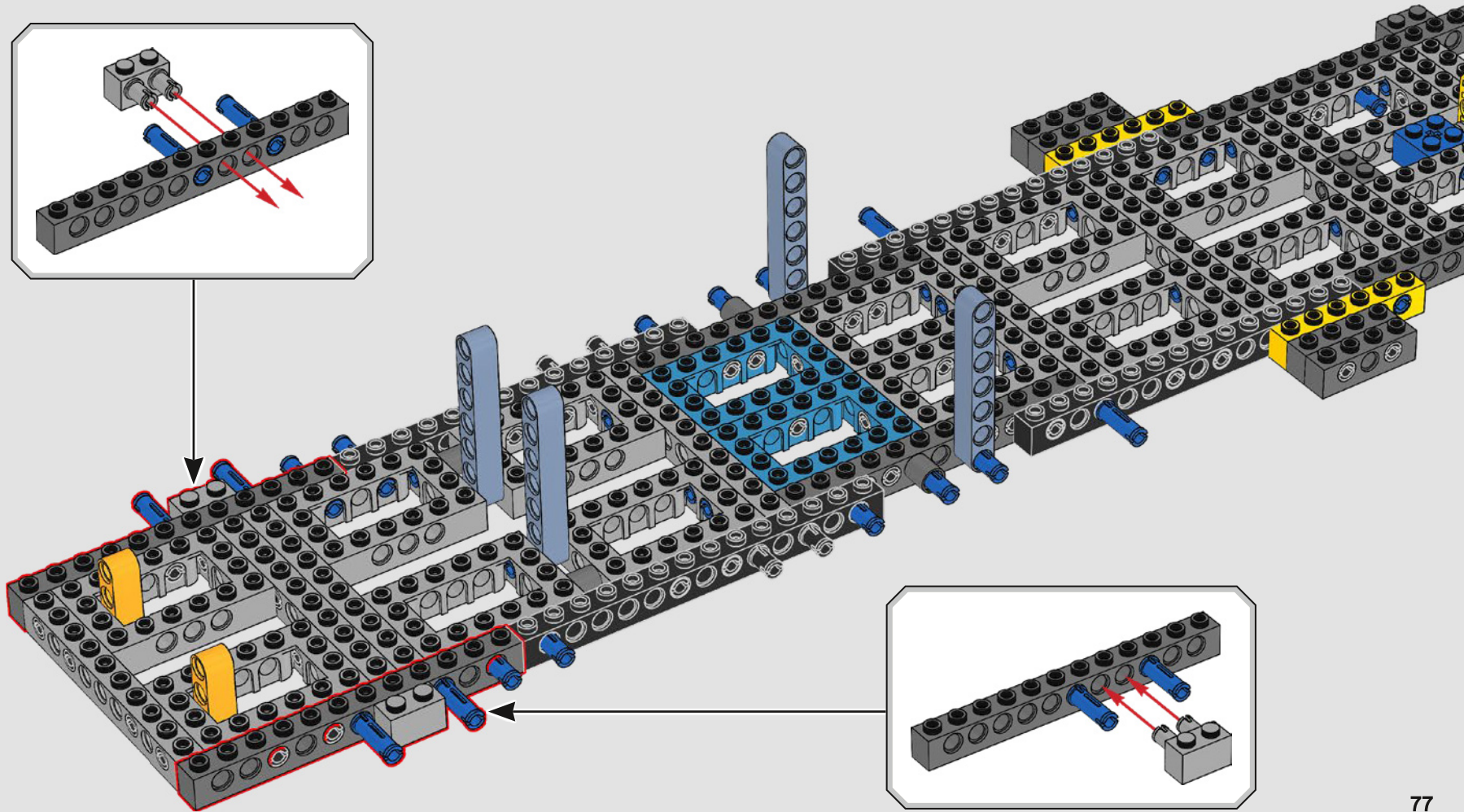
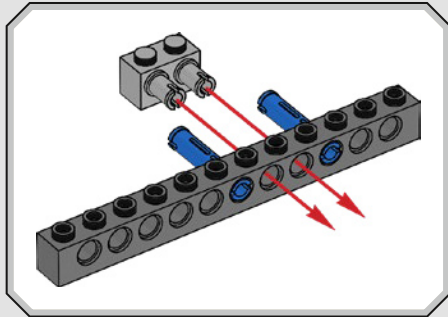

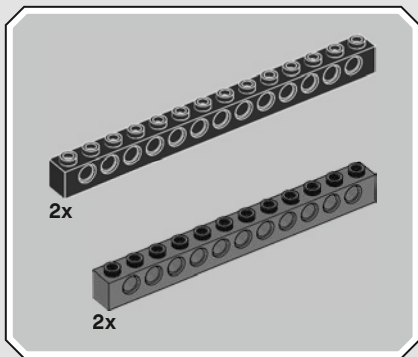

27

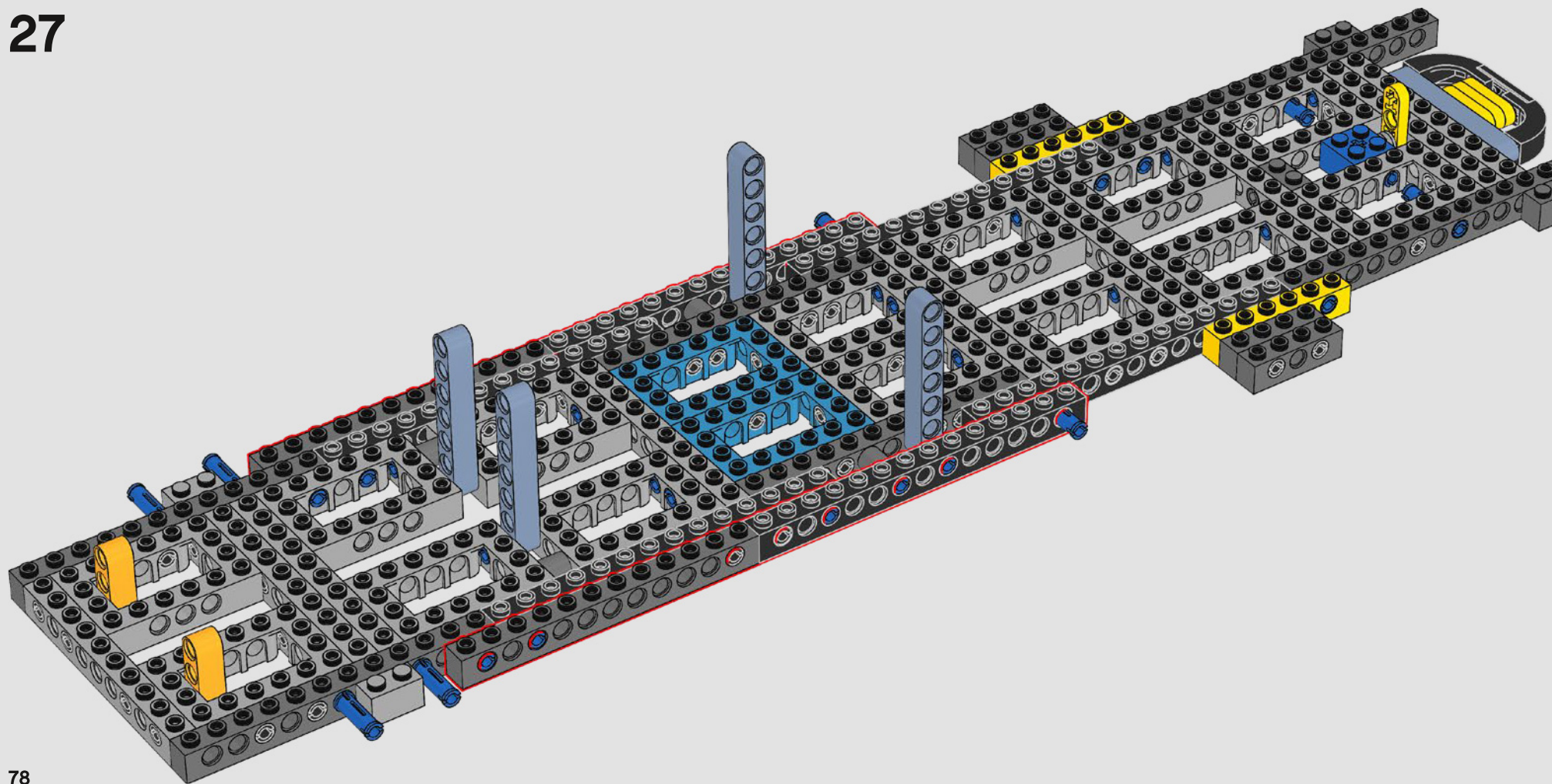

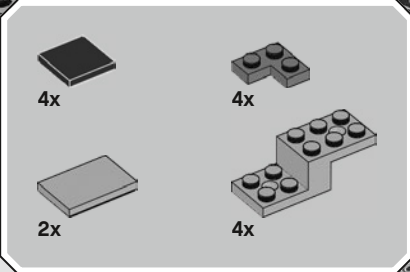
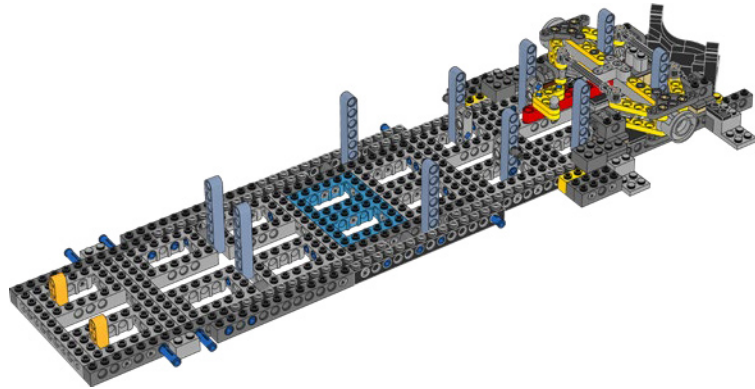
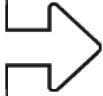

28

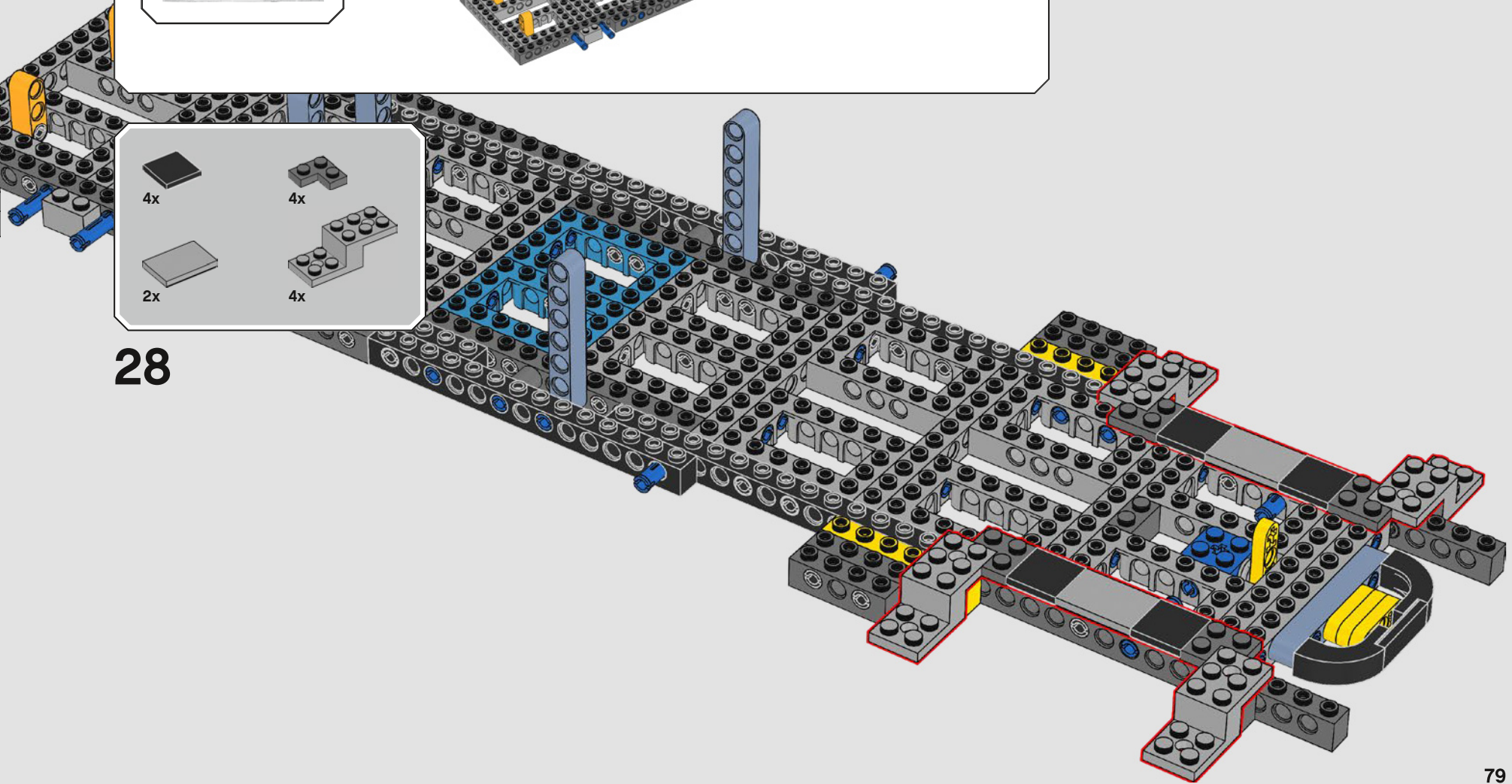

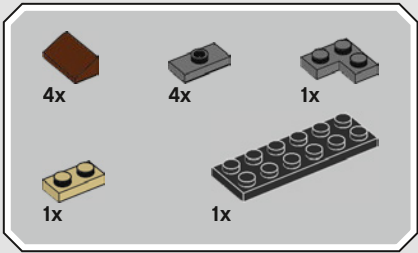

# 29

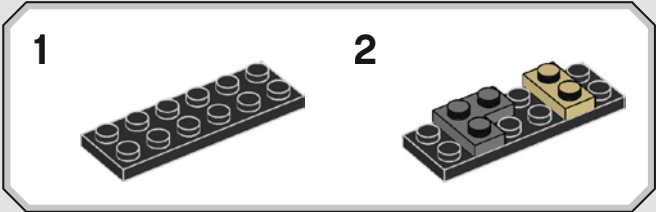
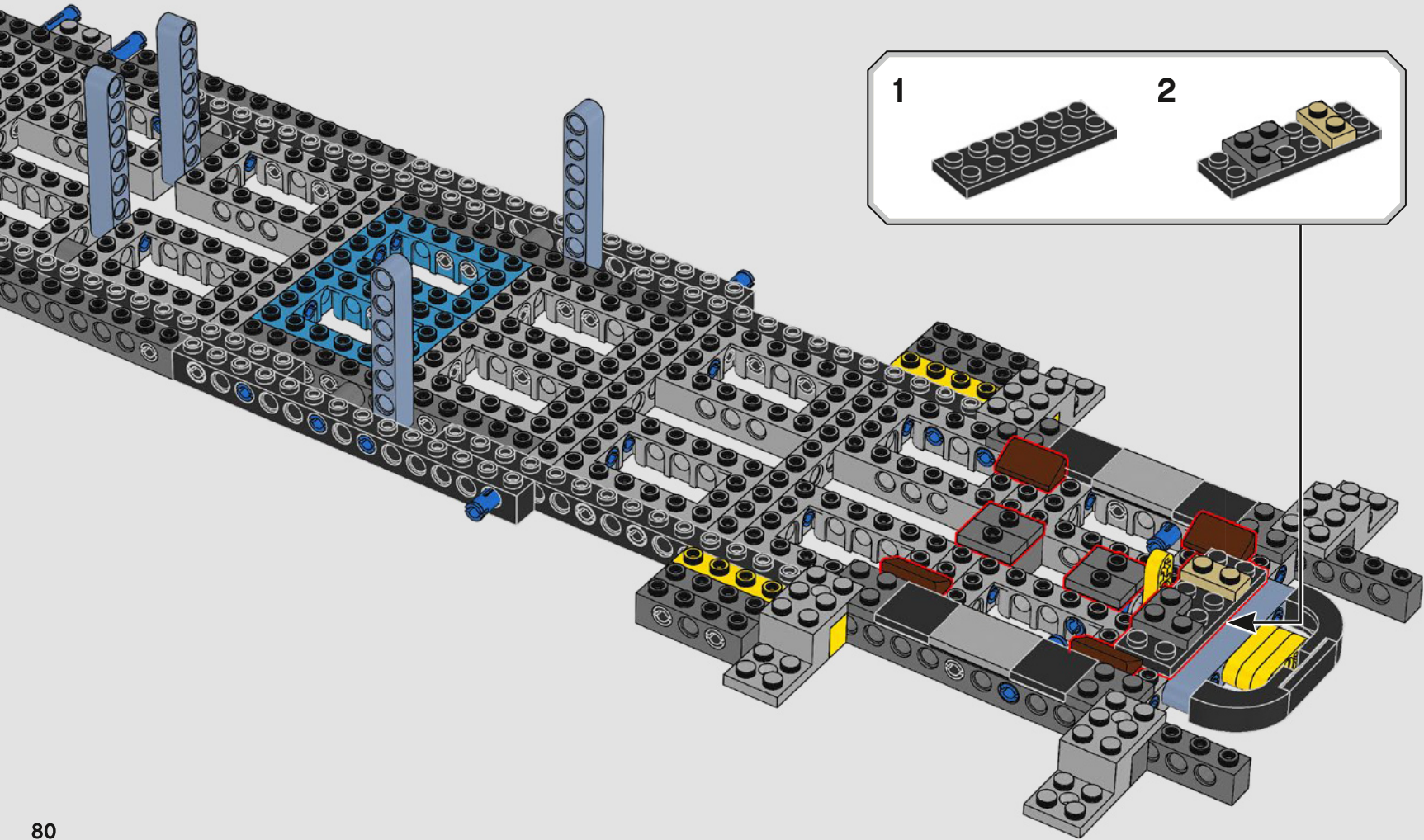



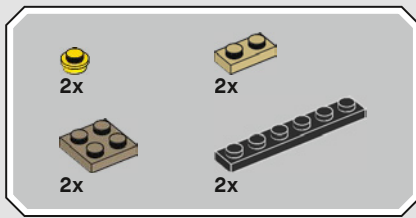

30

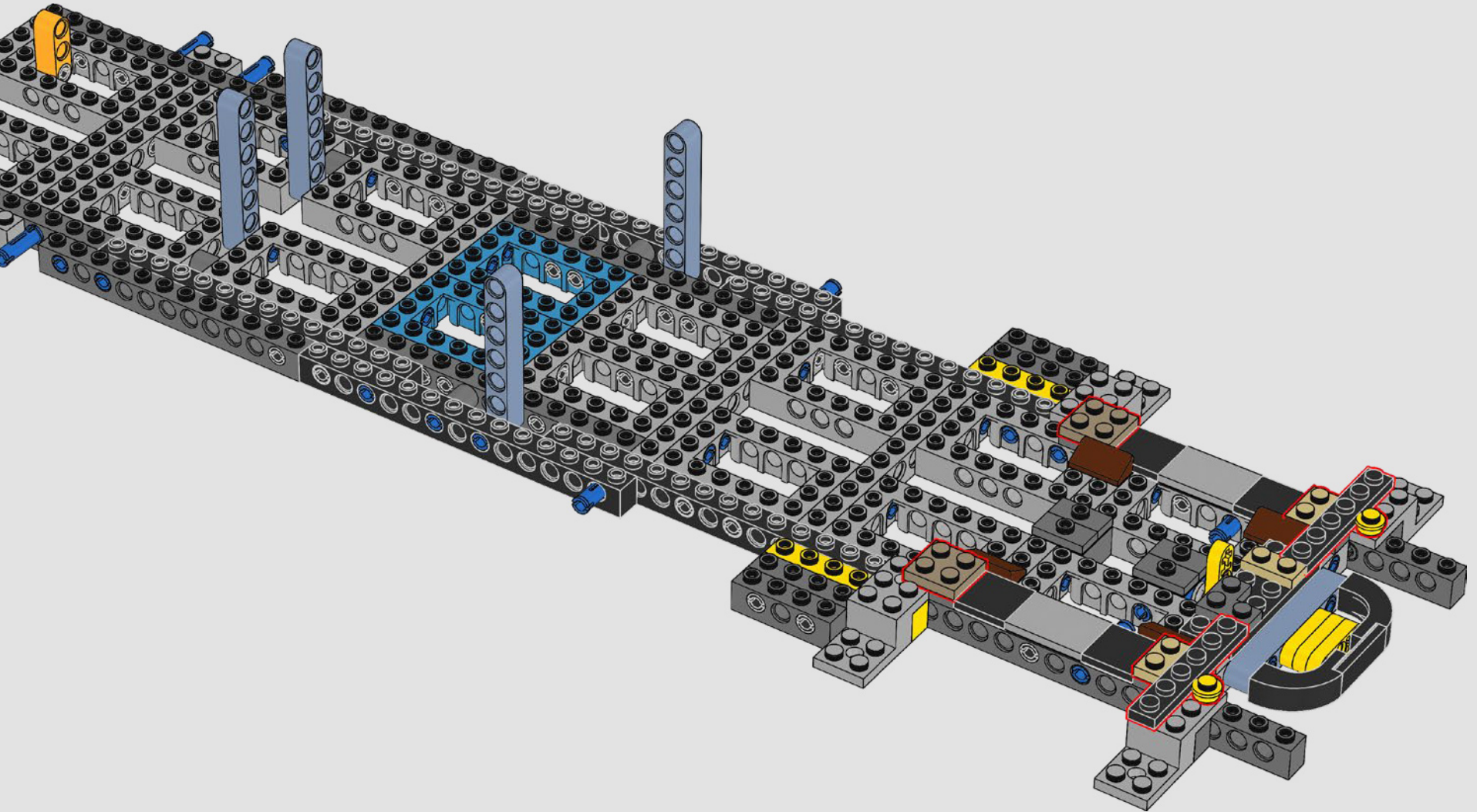

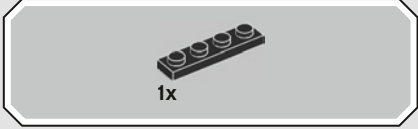
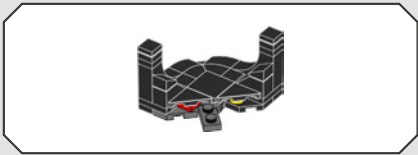

31

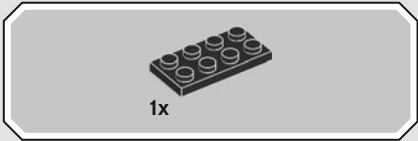
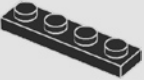

32

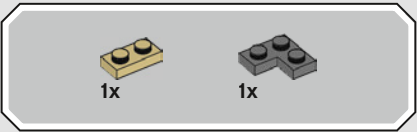
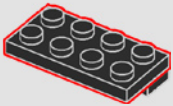

33

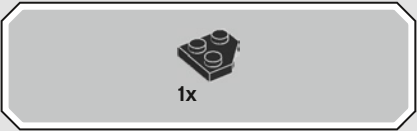
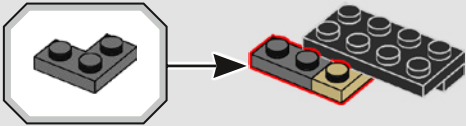

34

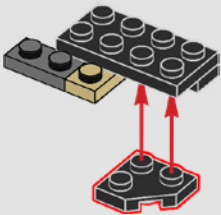

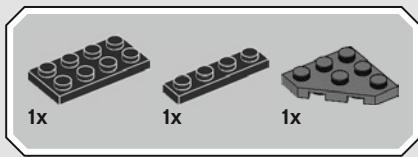

35

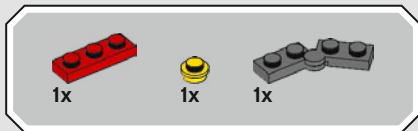
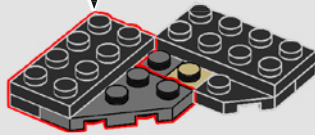
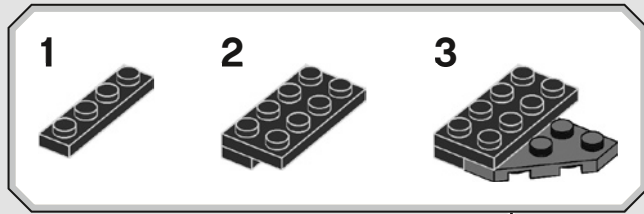

36

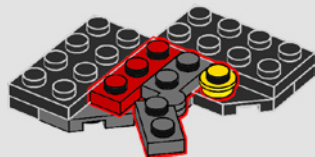

37

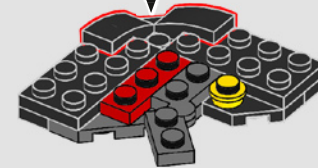
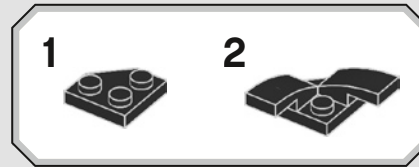

38

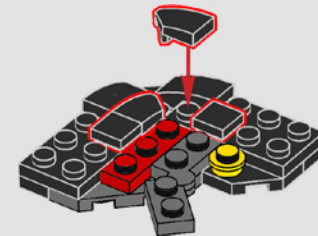

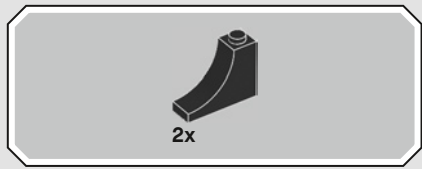

39

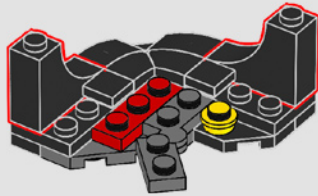

40

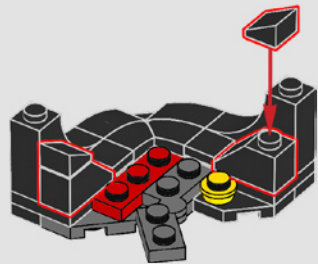

41

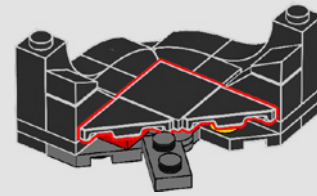

42

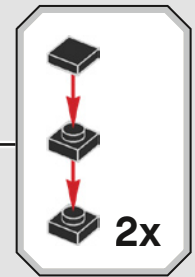
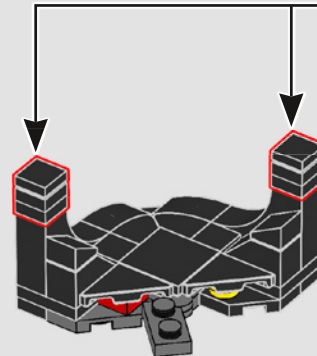

43

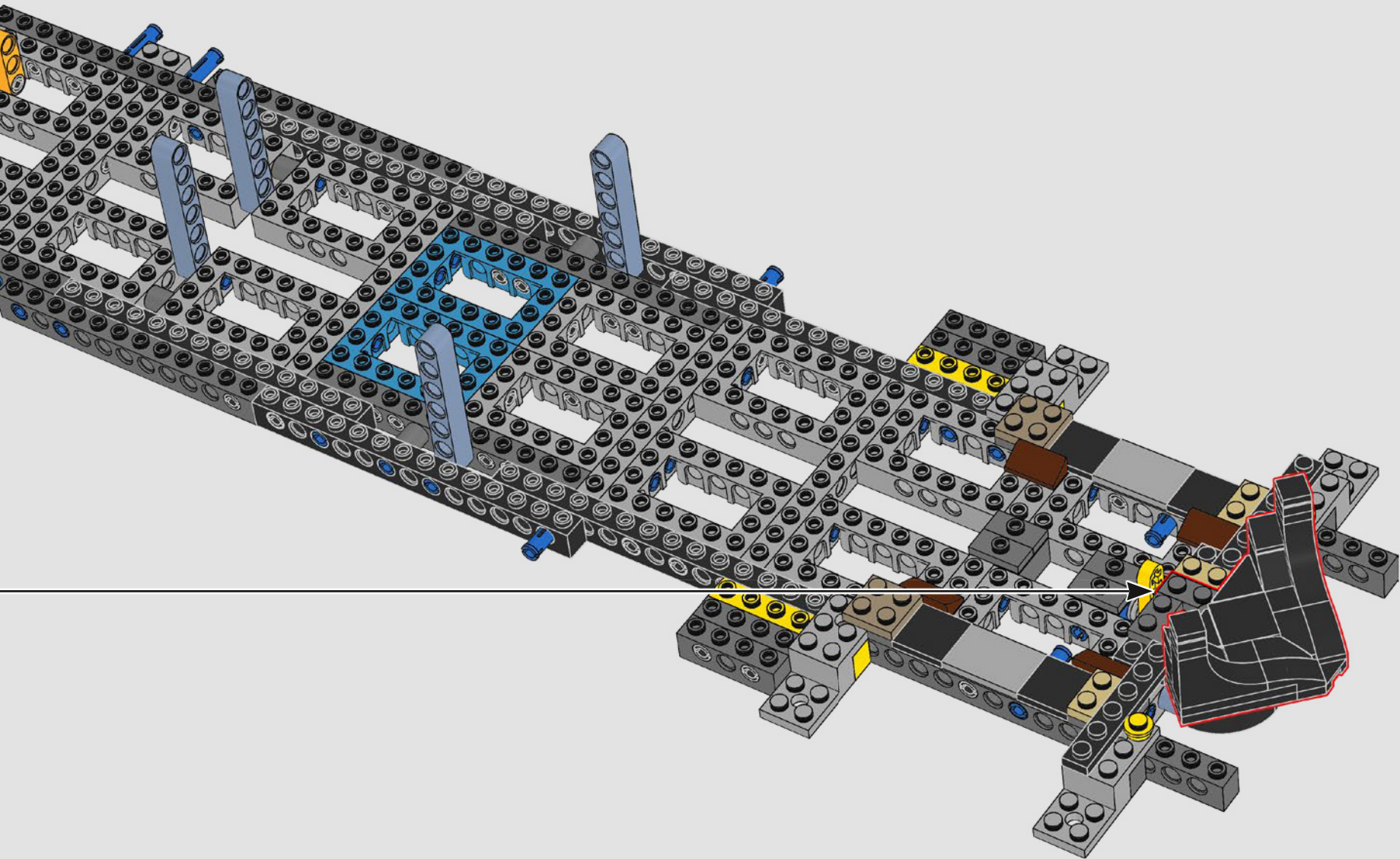

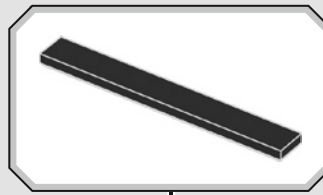
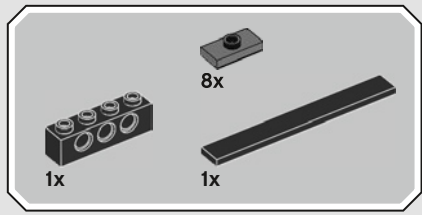

44

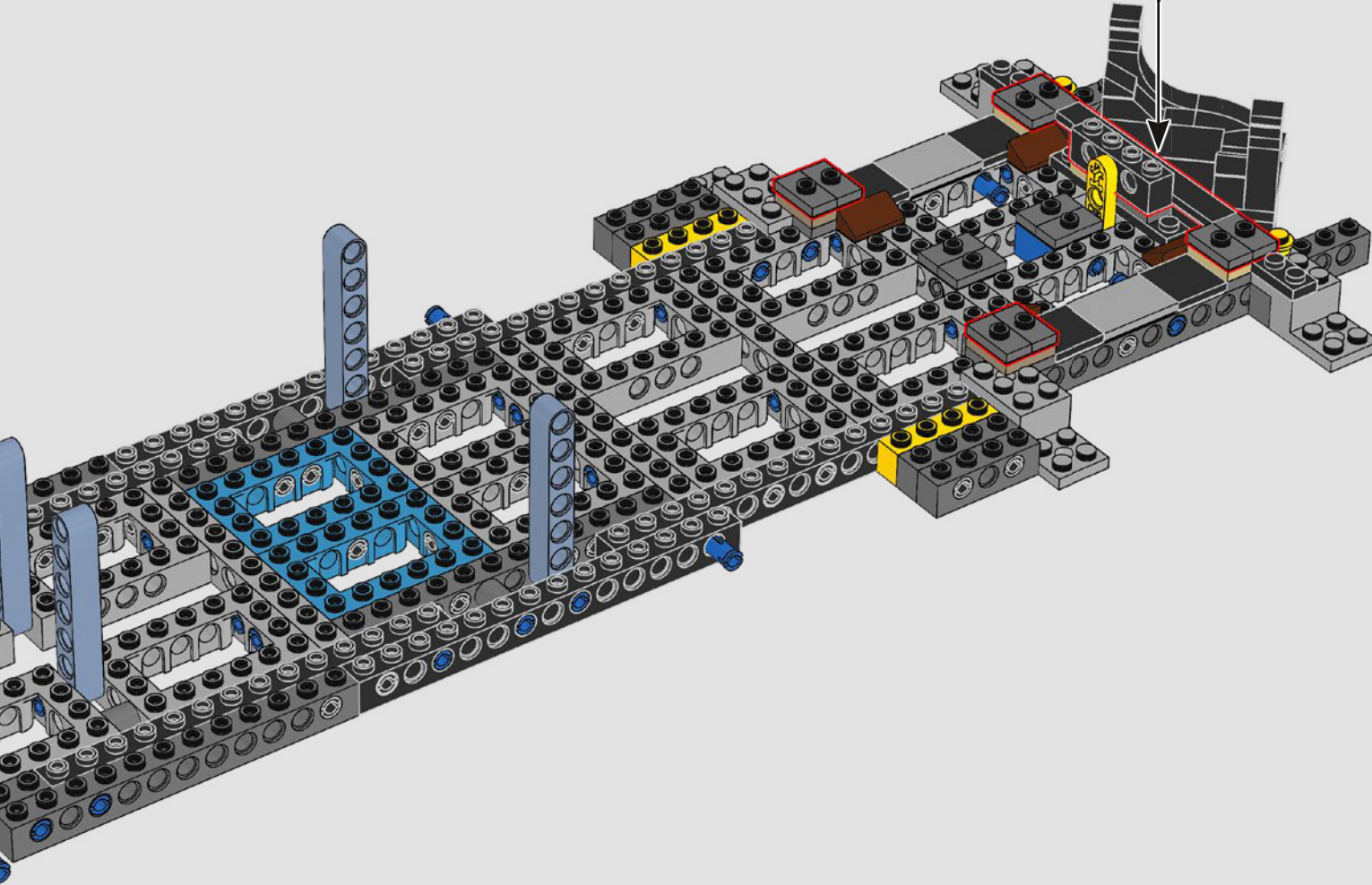

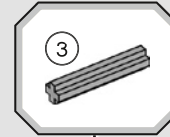
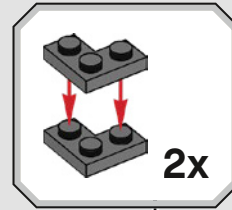
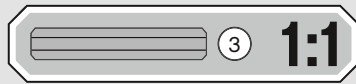
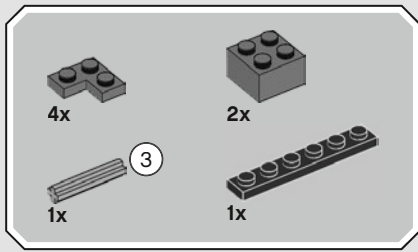

45

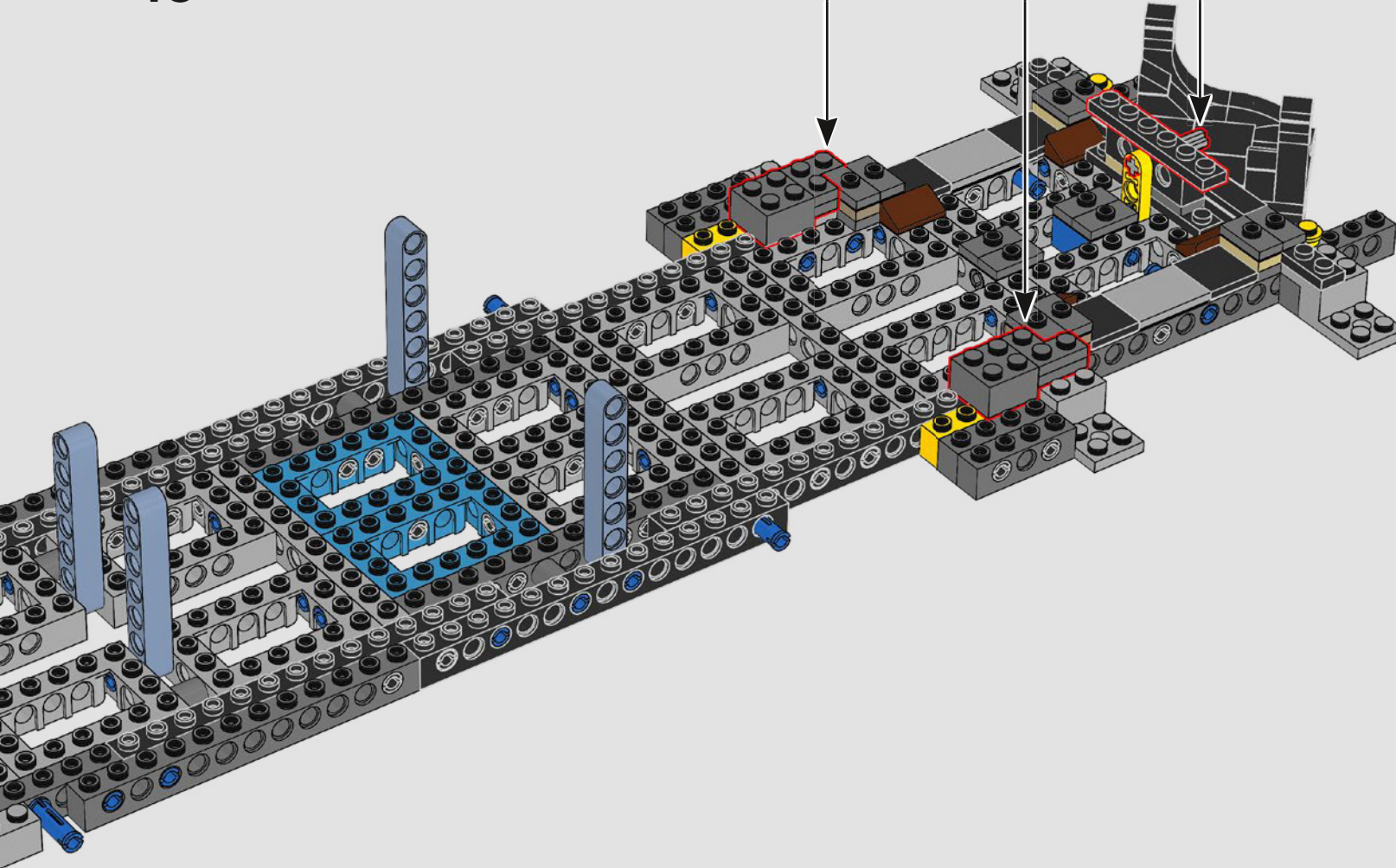

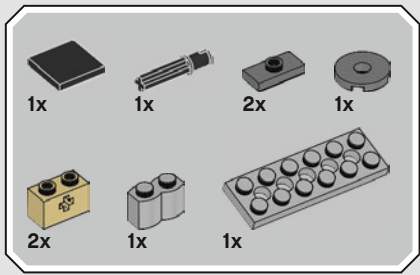

46

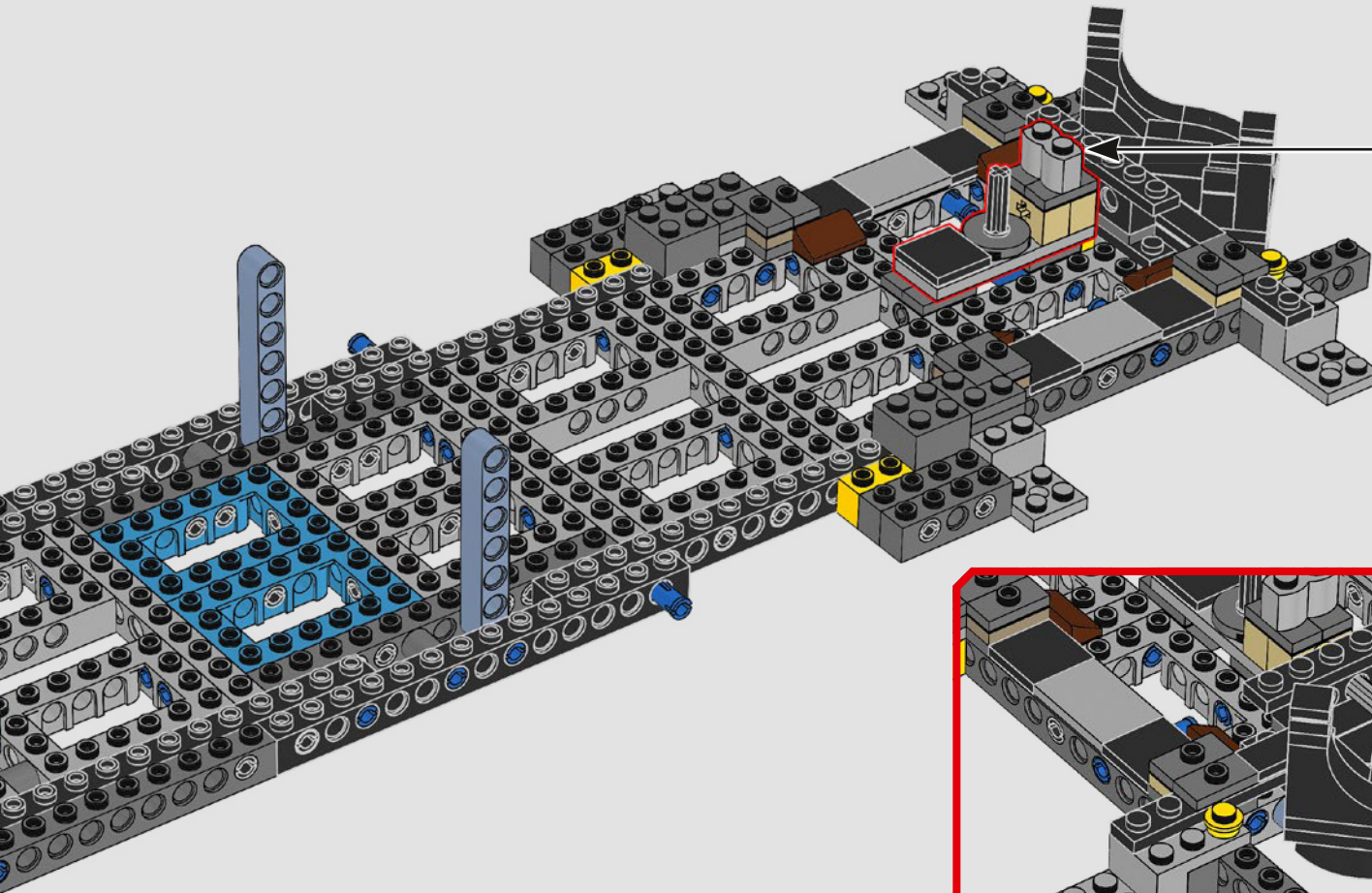
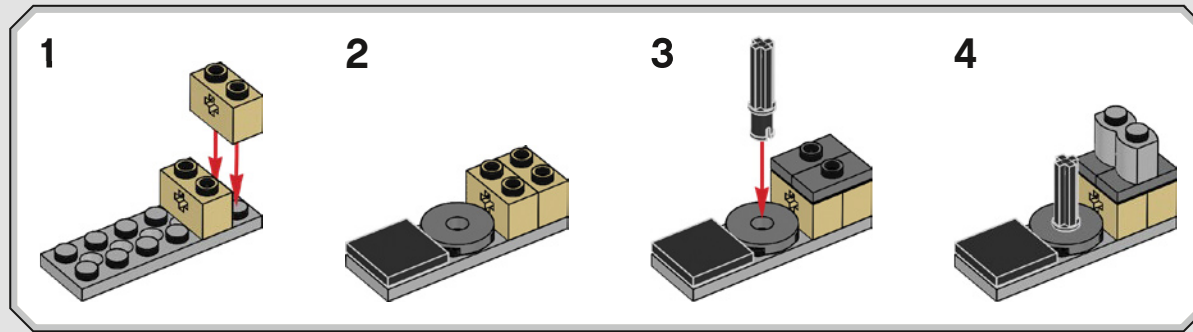



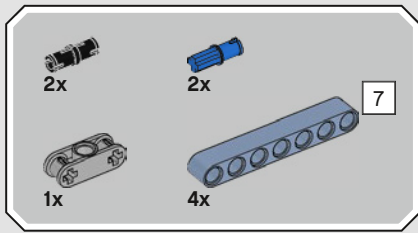

47

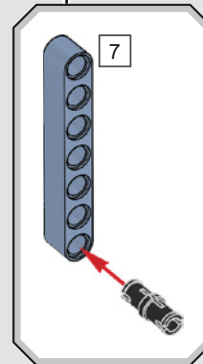
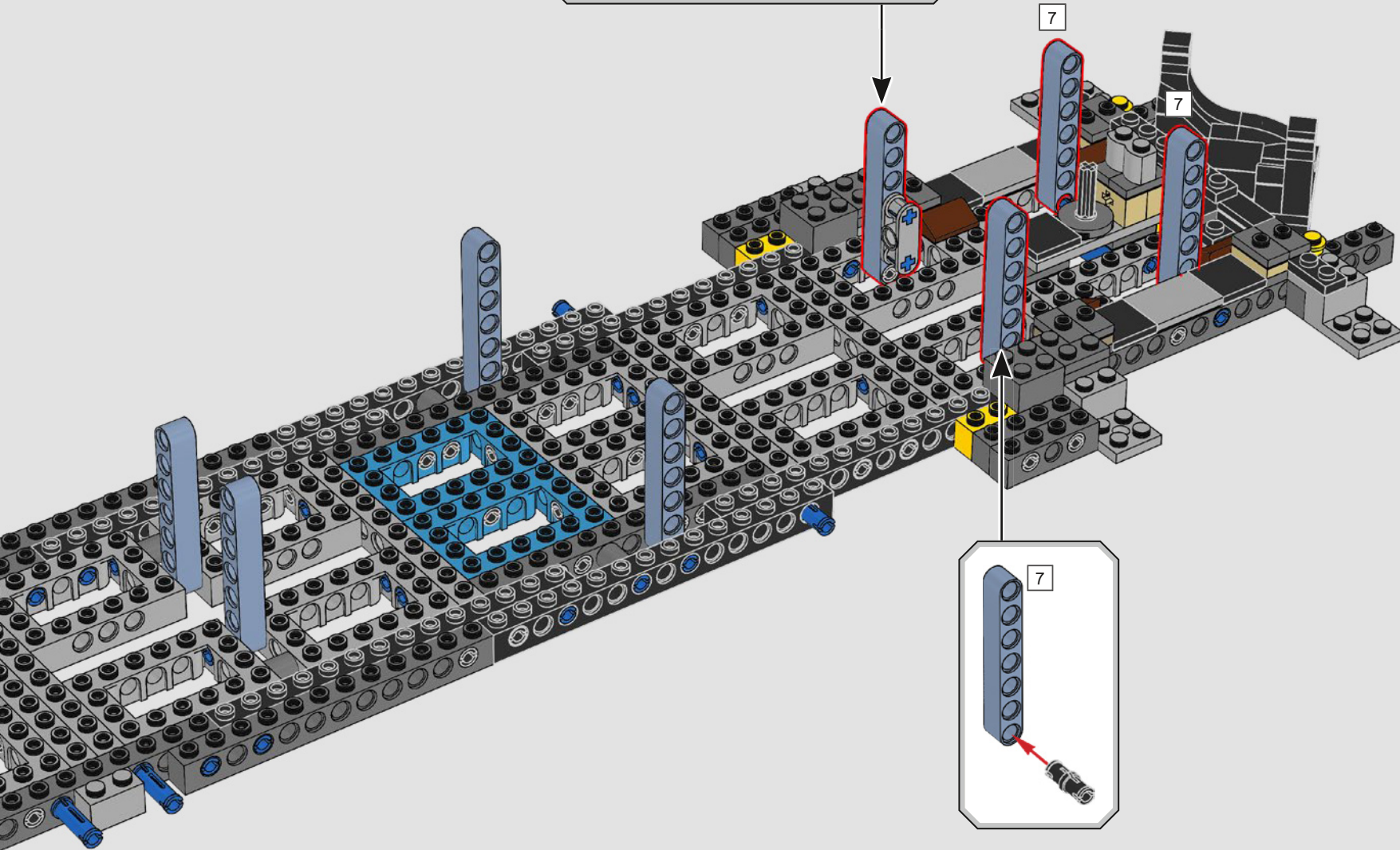
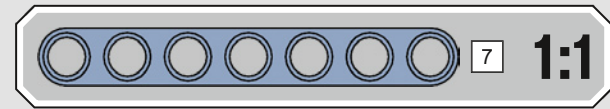
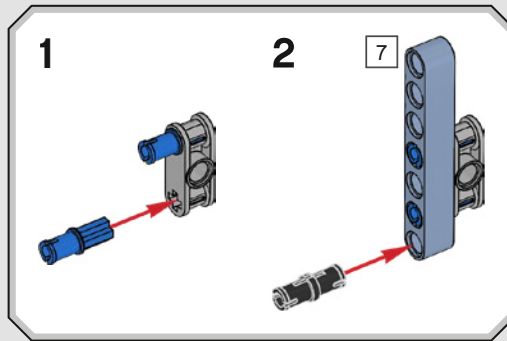

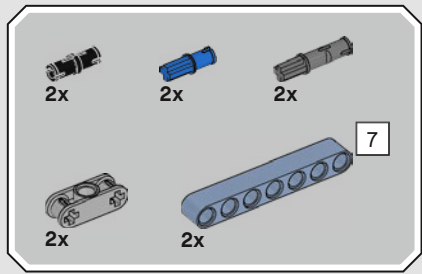

48

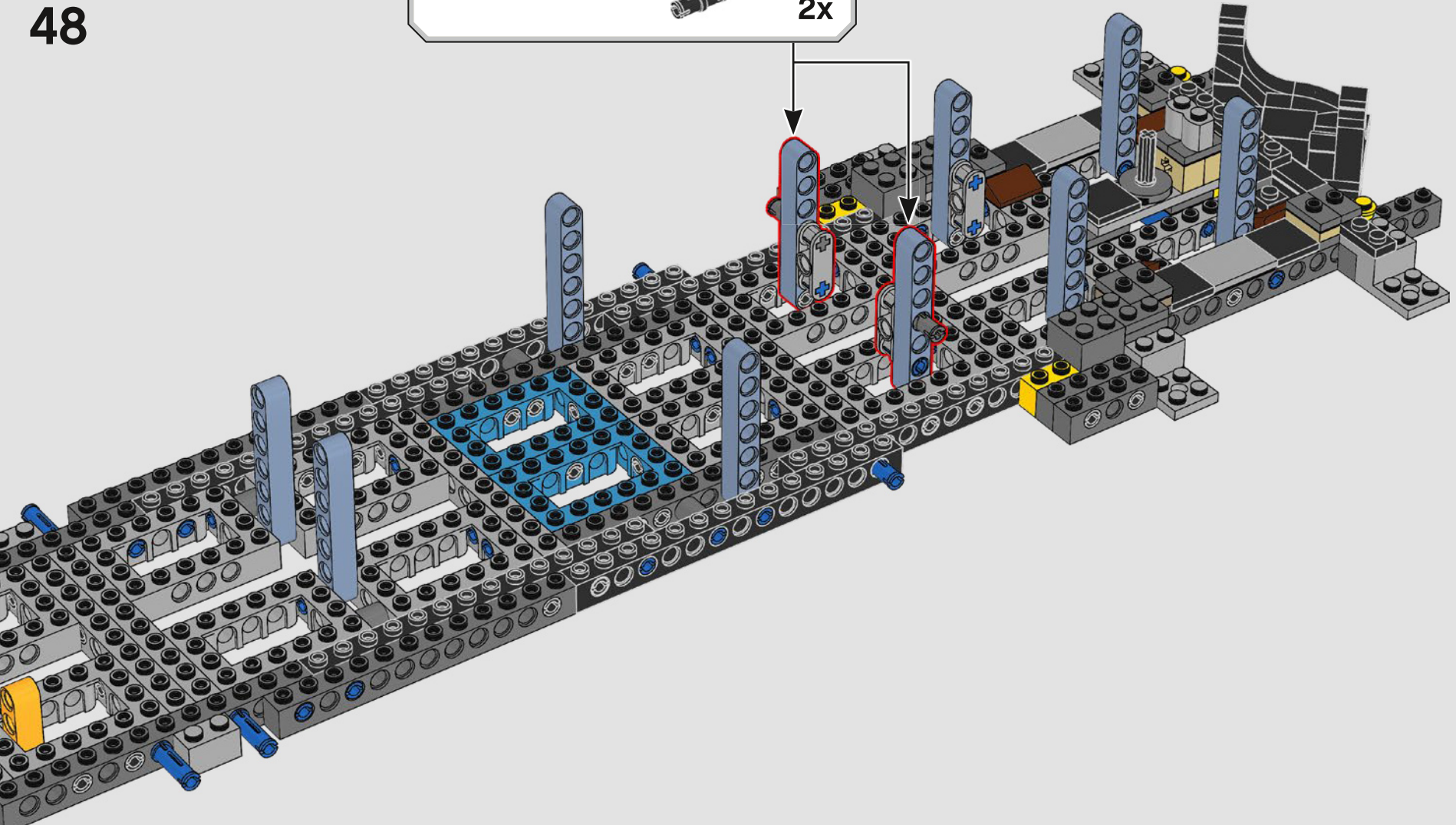
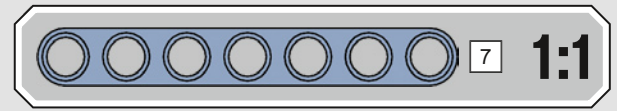
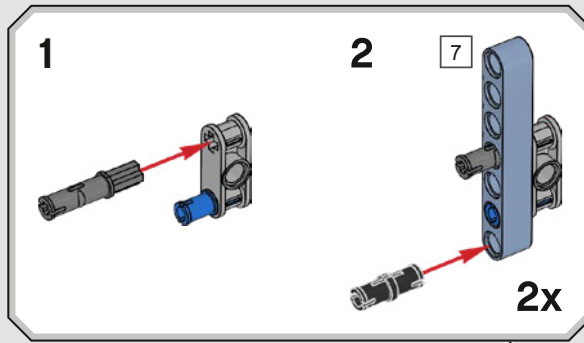

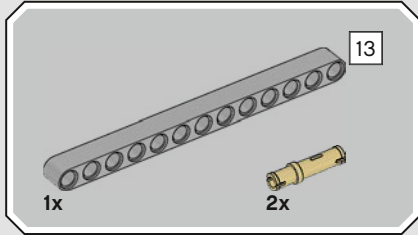
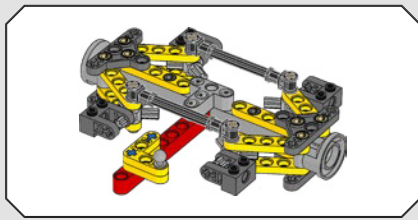

49

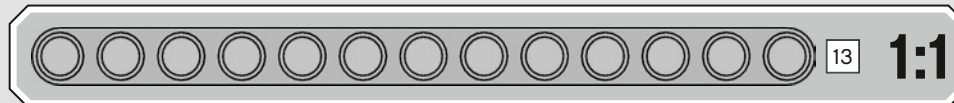
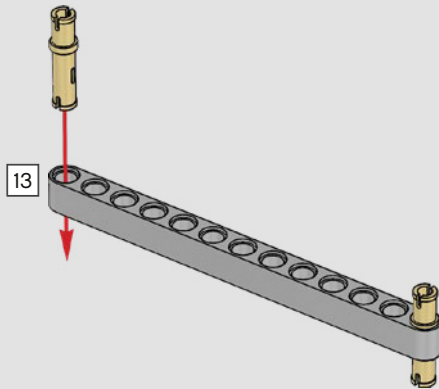

50

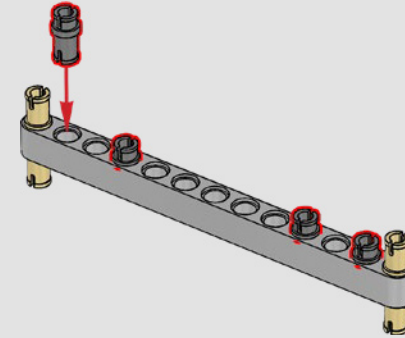

51

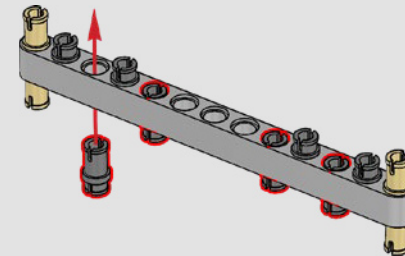

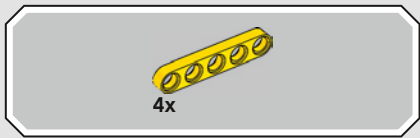

52

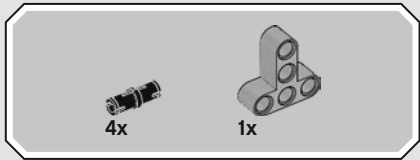
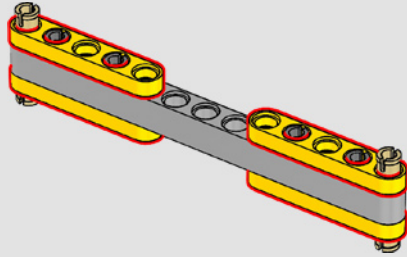

53

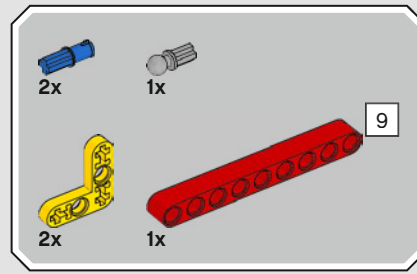
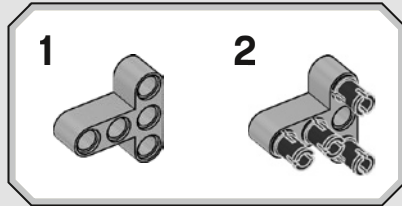
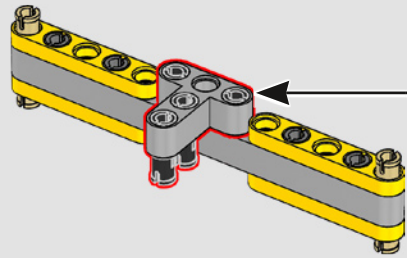

54

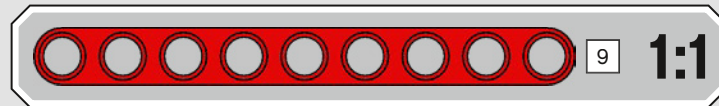
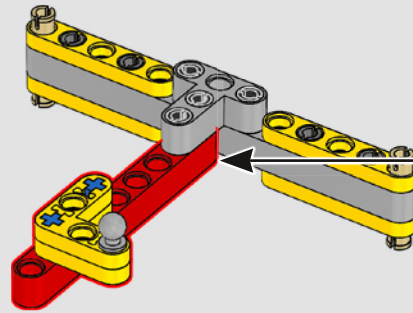
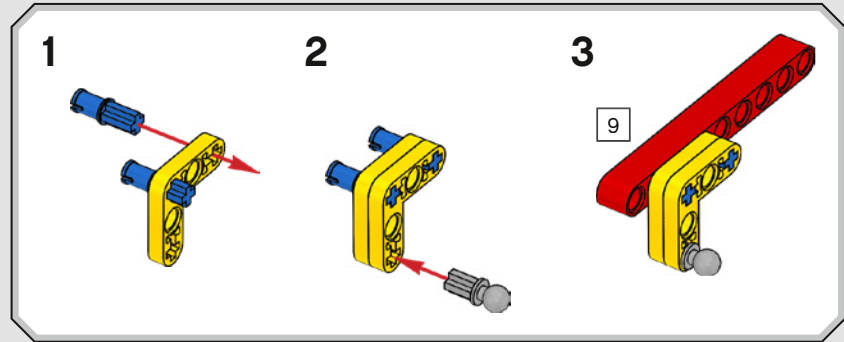

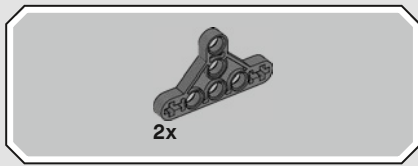

55

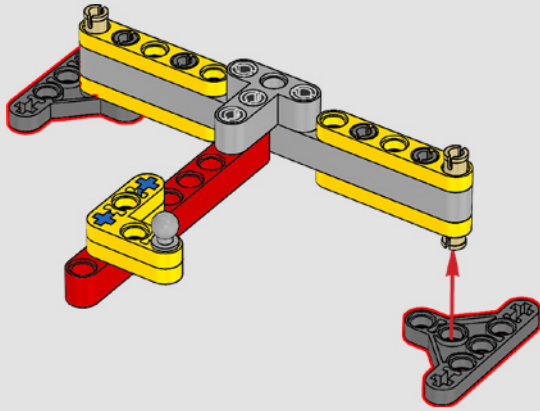

56

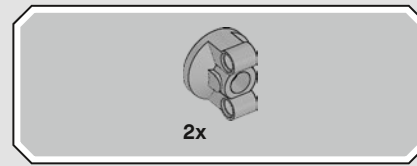
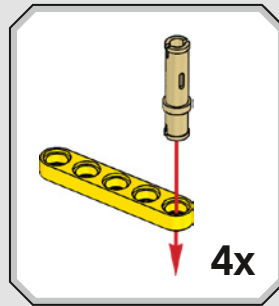
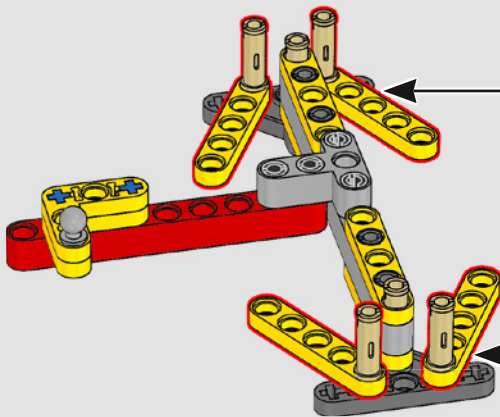

57

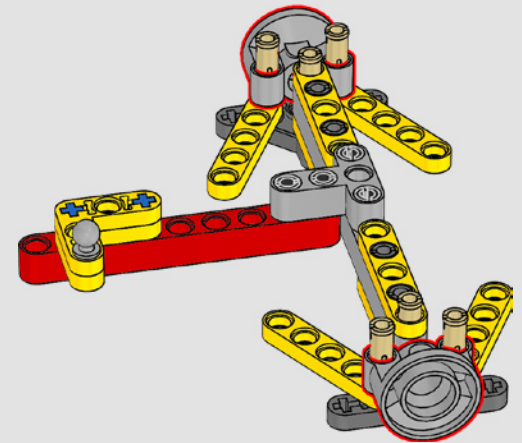

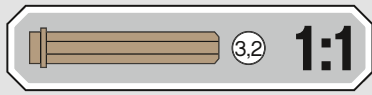
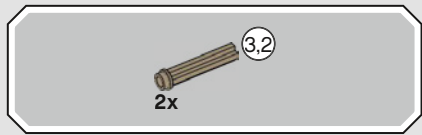

58

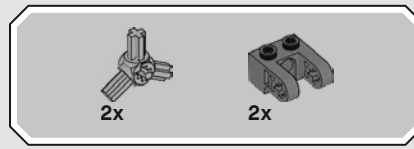
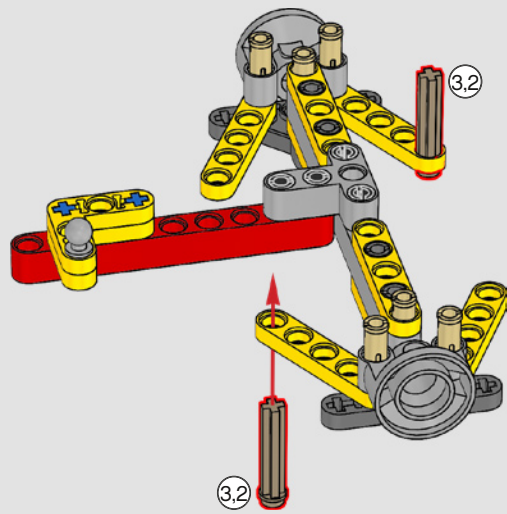

59

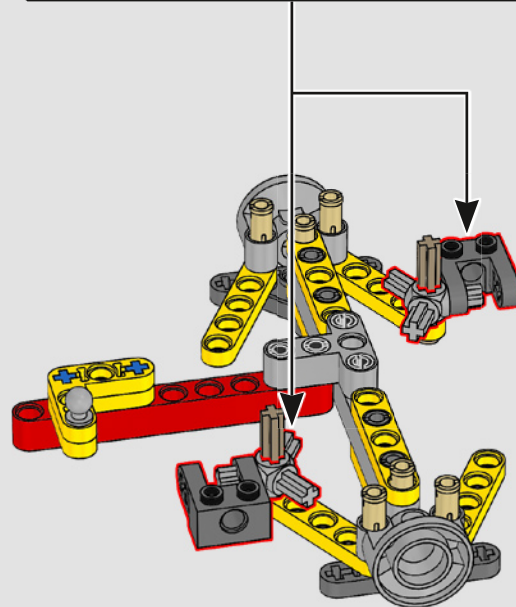
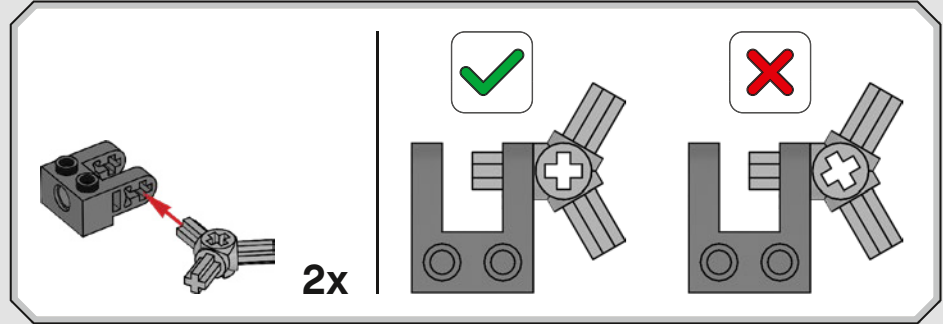

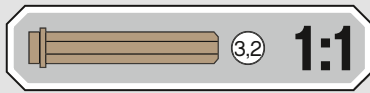
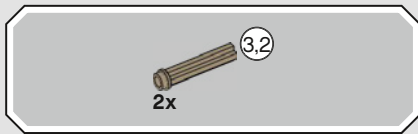

60

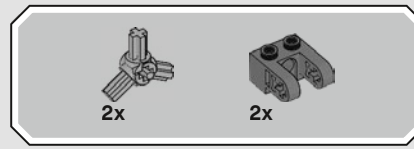
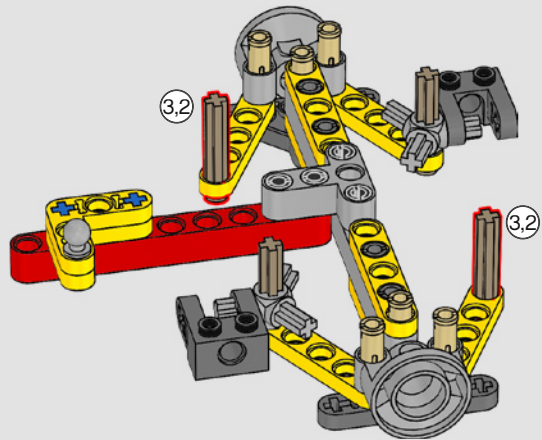

61

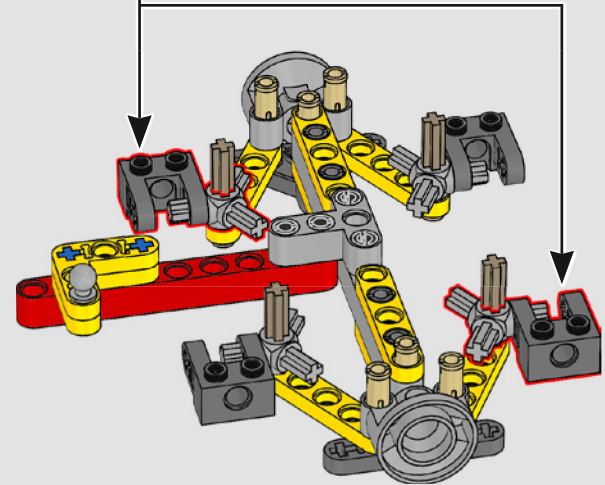
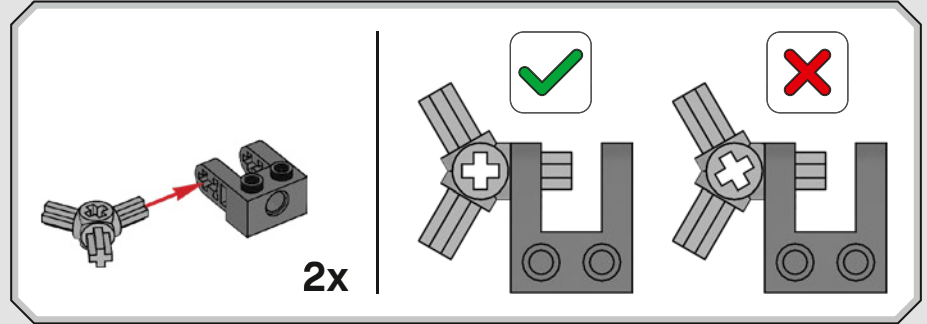

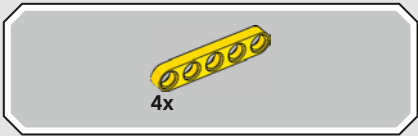

62

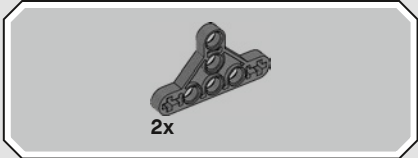
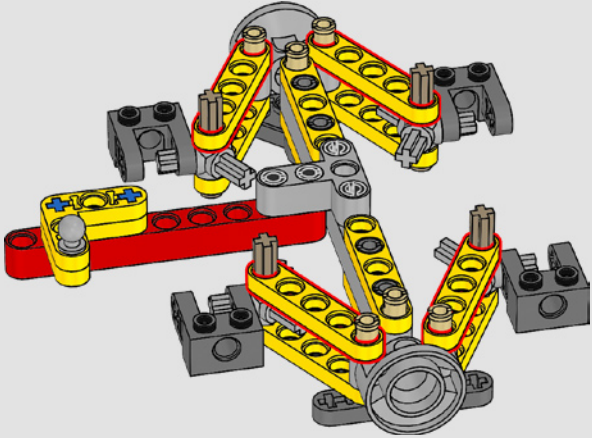

63

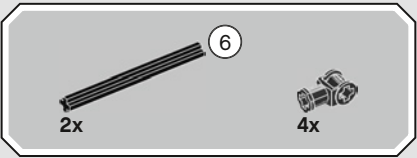
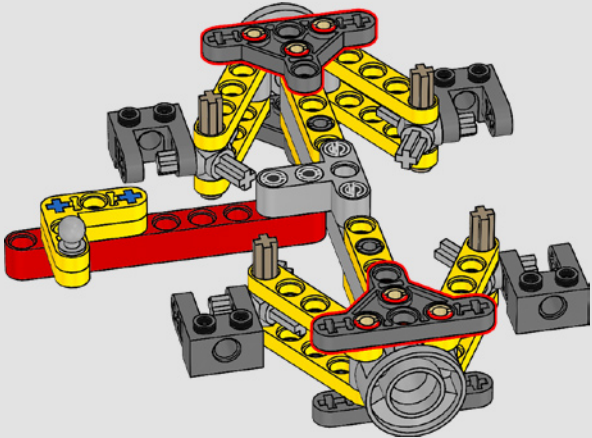

64

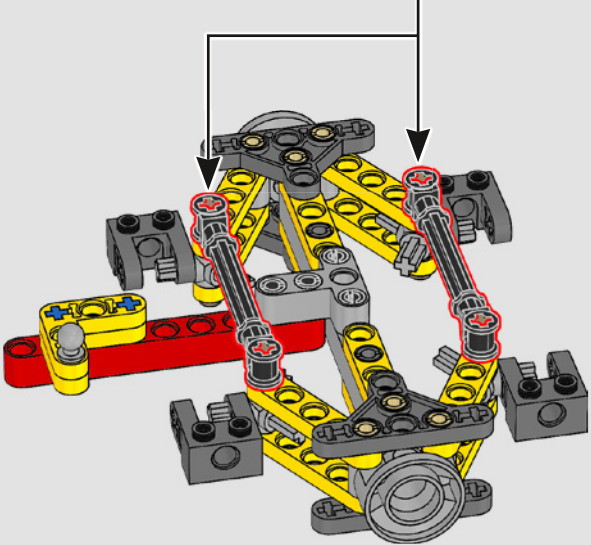
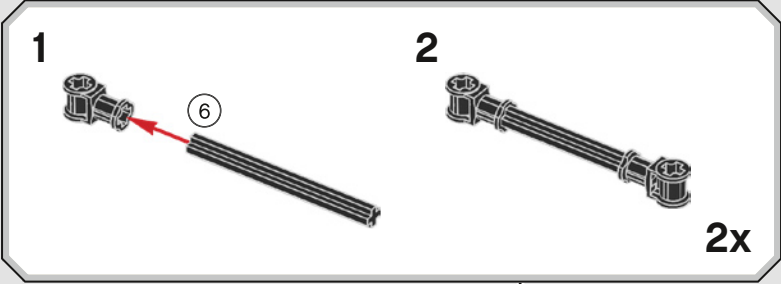



65

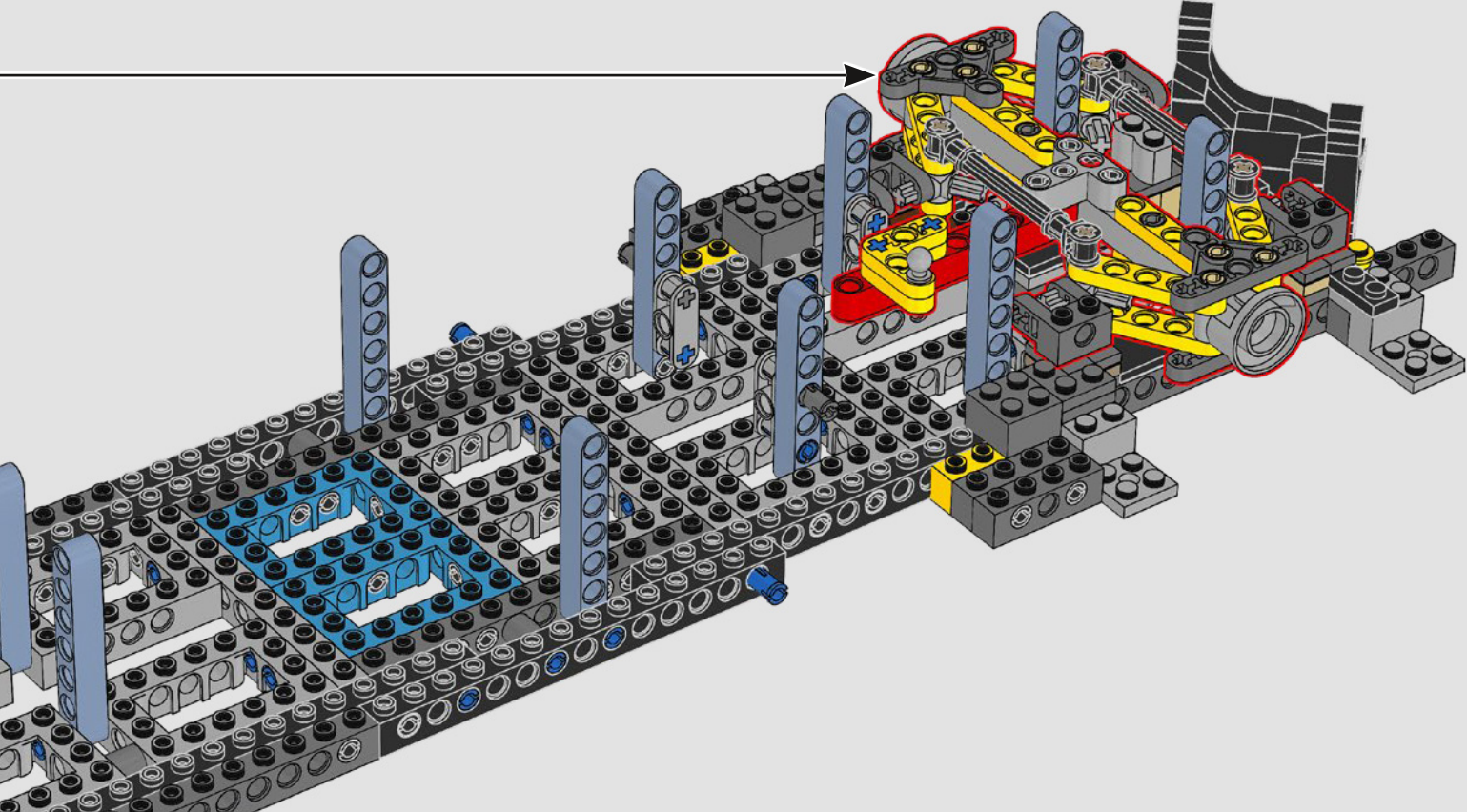
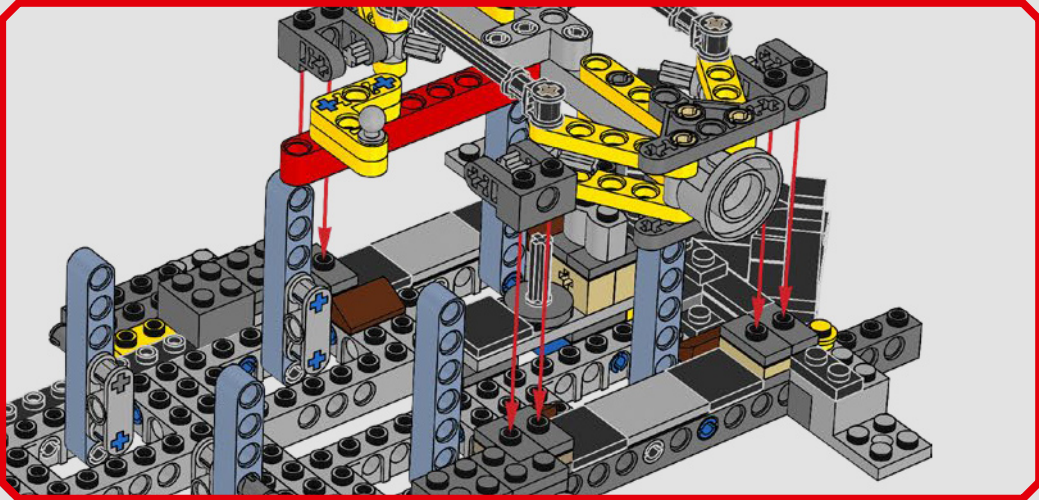

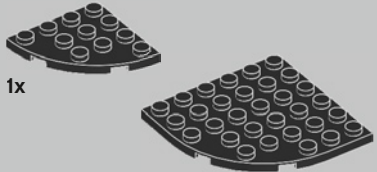
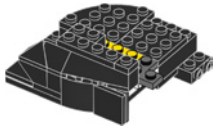
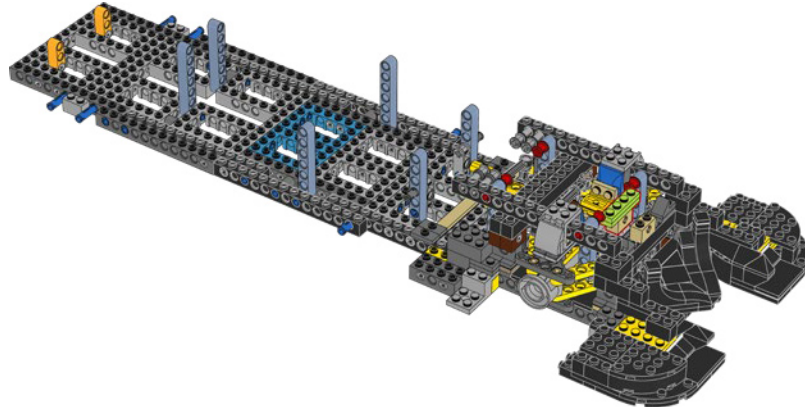
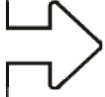
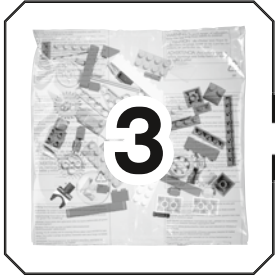

66

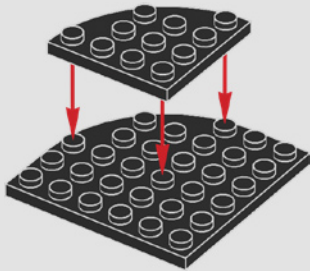

67

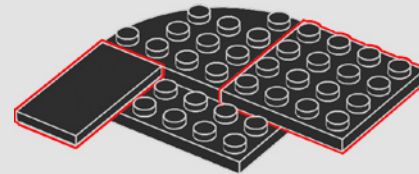

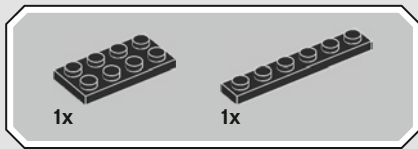

68

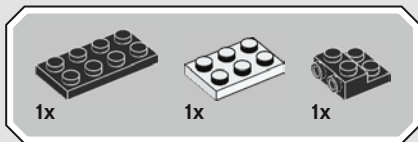
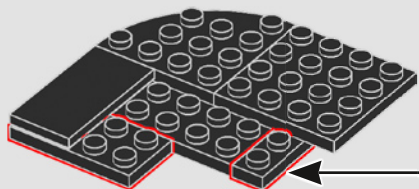
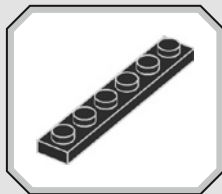

69

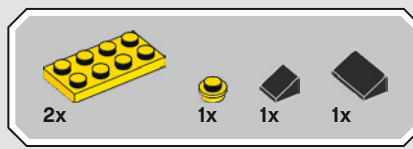
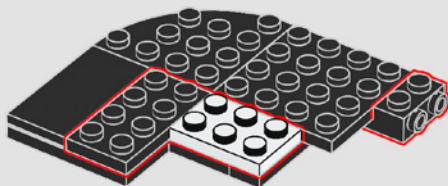

70

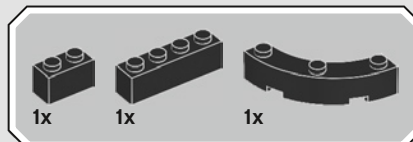
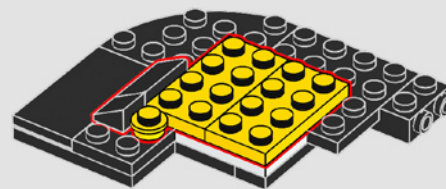

71

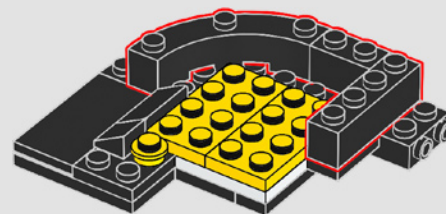

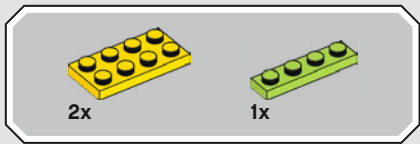

72

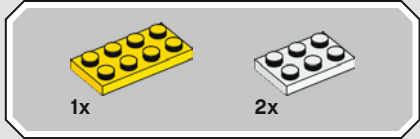
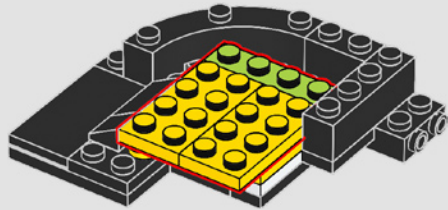

73

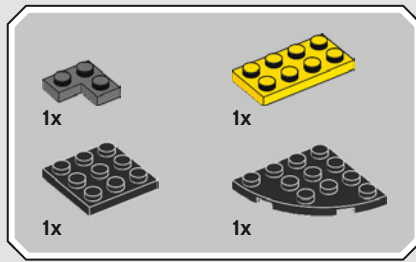
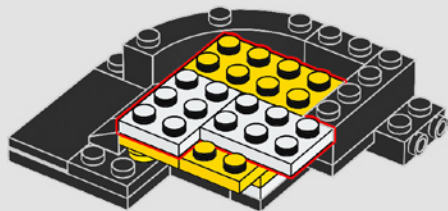

74

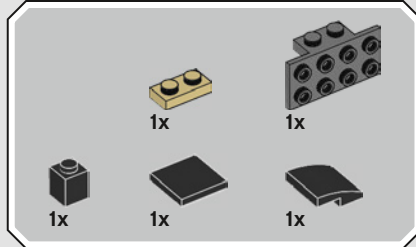
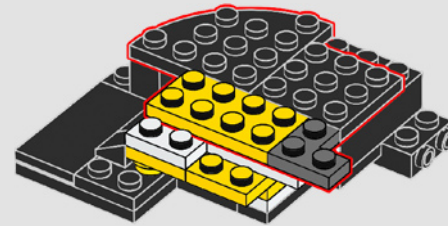

75

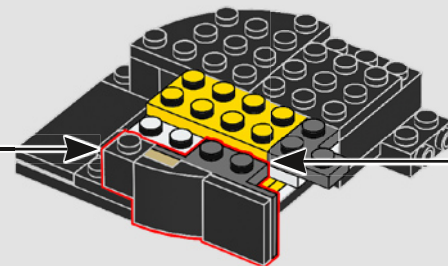
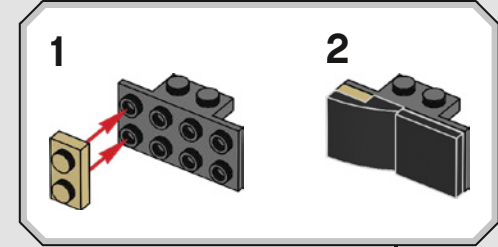

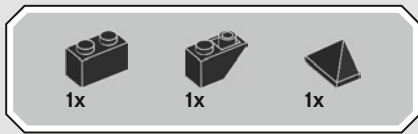

76

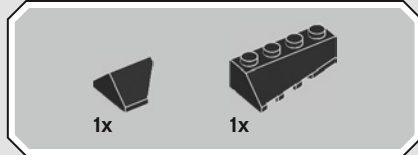
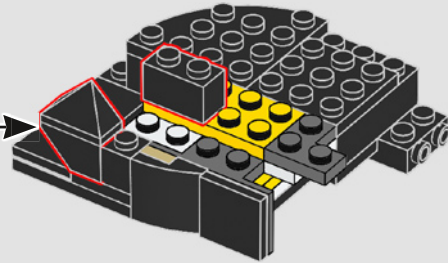
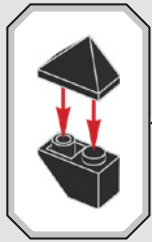

77

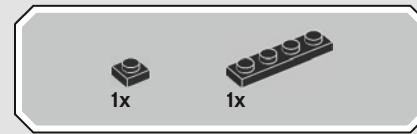
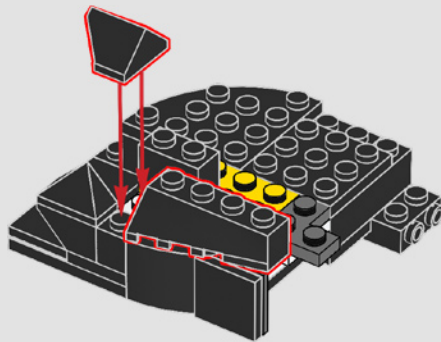

78

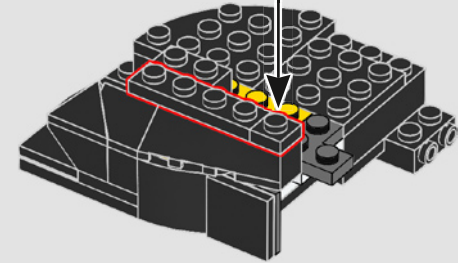

79

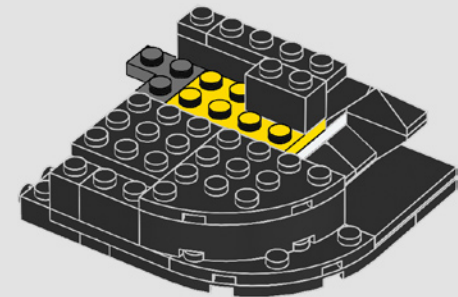
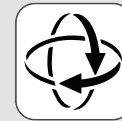

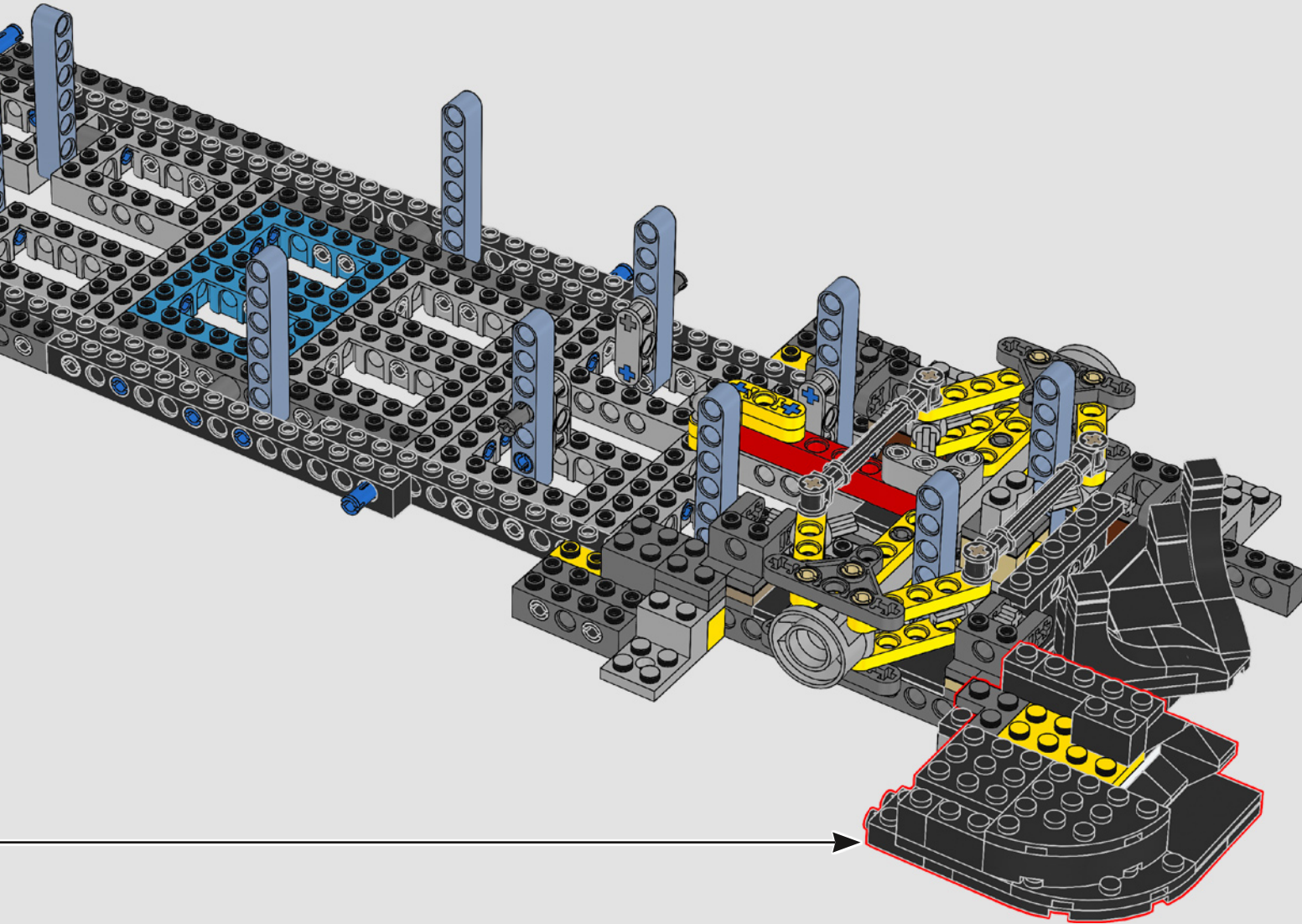

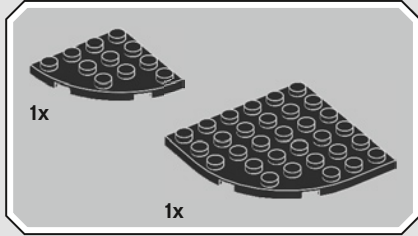
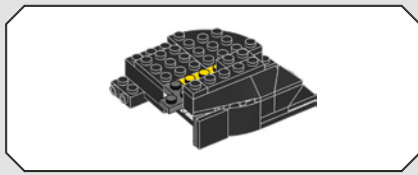

81

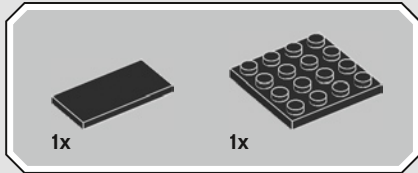
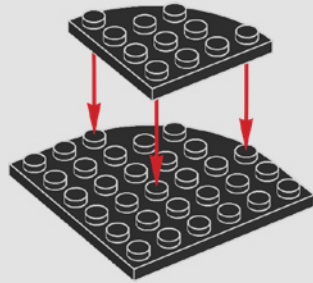

82

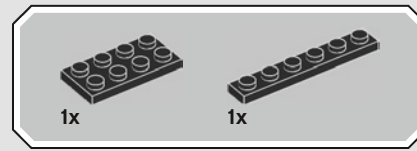
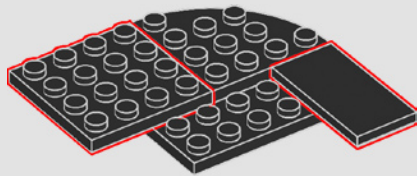

83

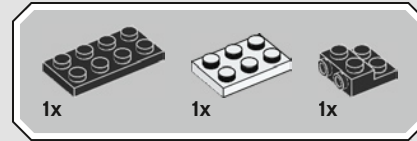
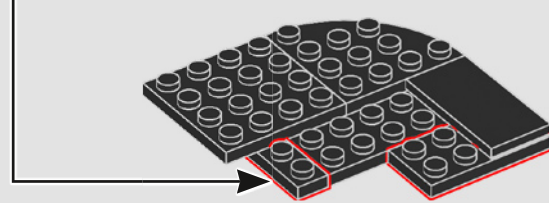
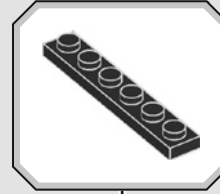

84

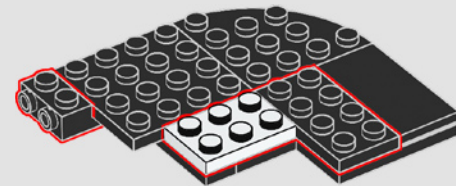

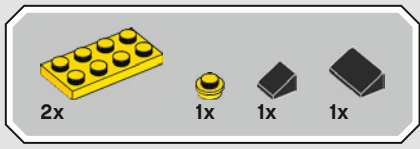

85

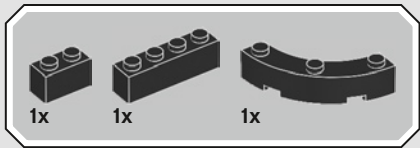
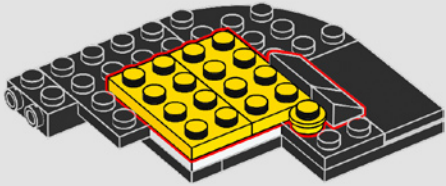

86

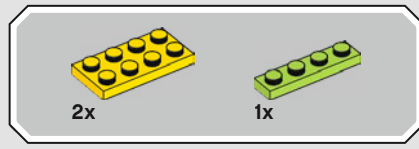
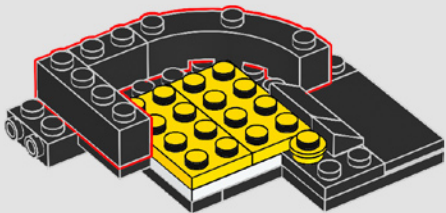

87

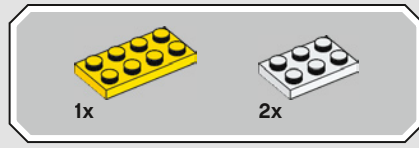
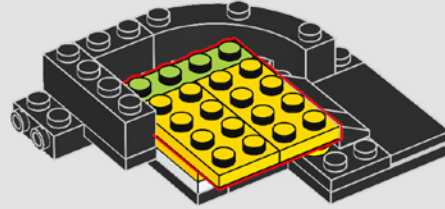

88

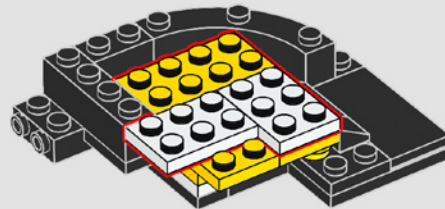



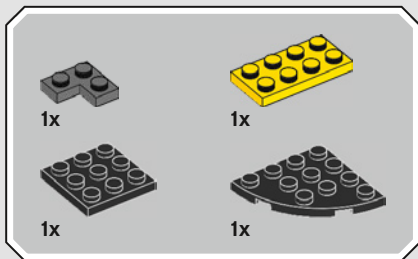

89

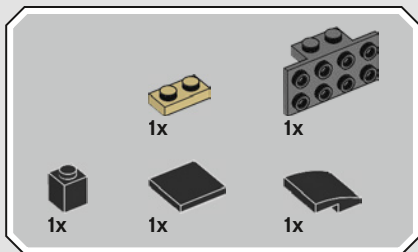
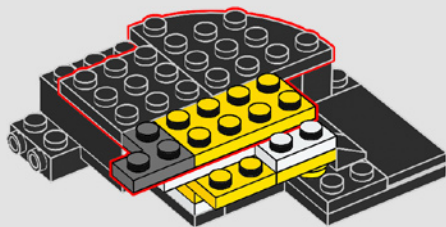

90

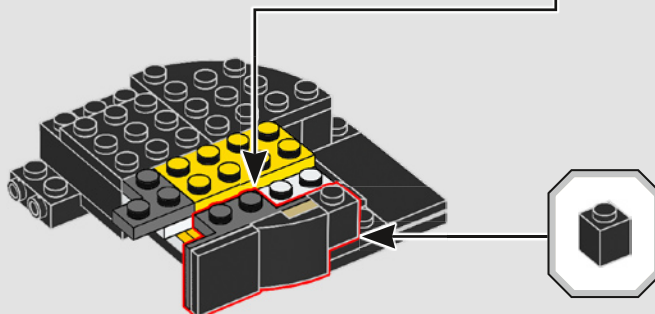
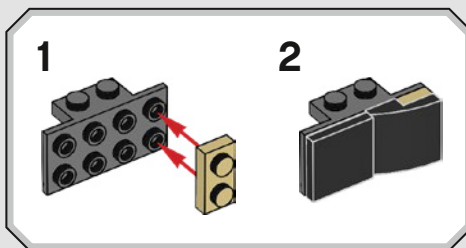

91

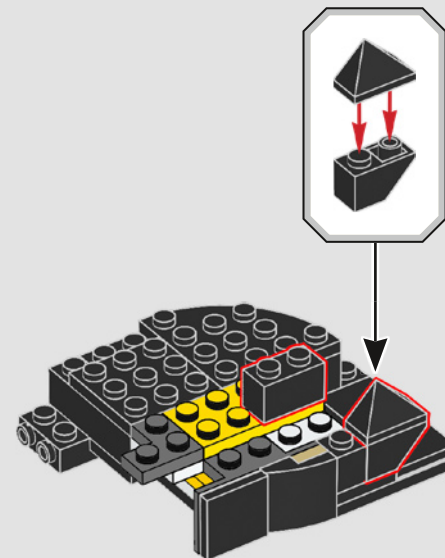

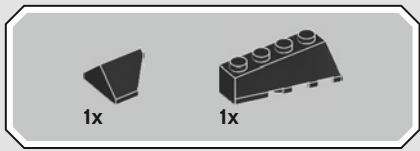

92

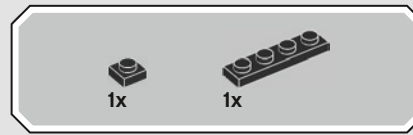
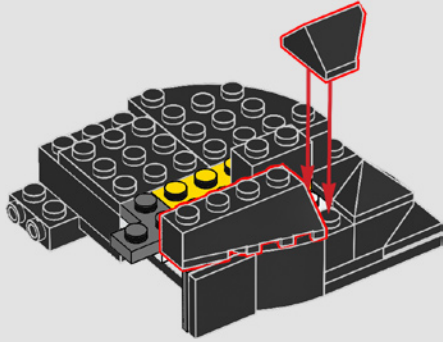

93

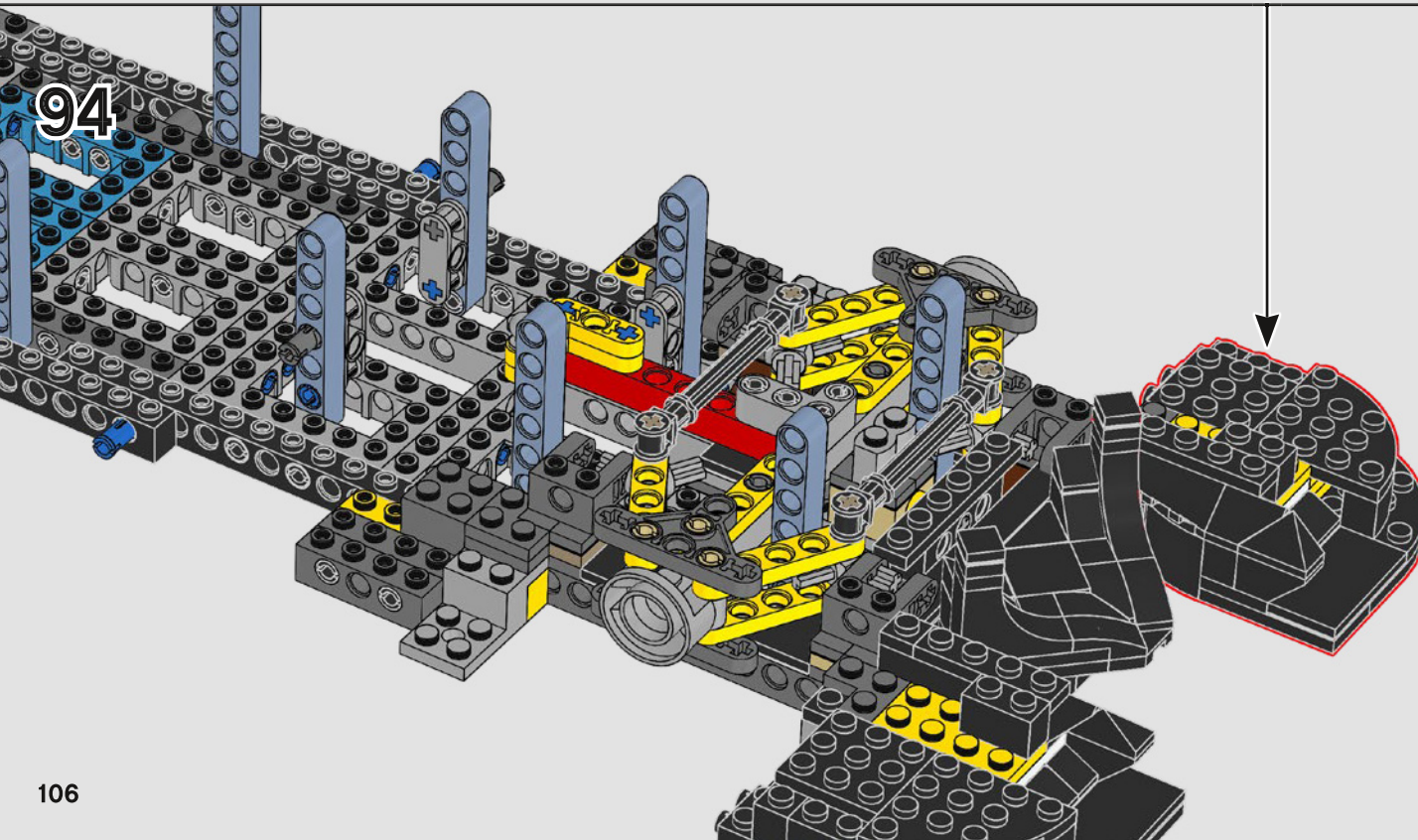
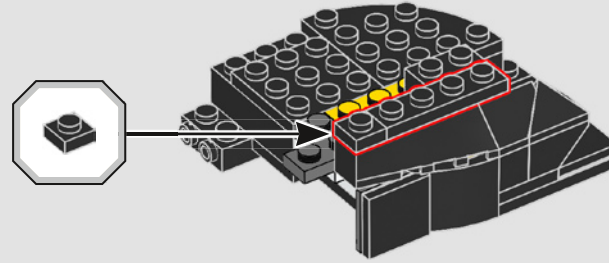

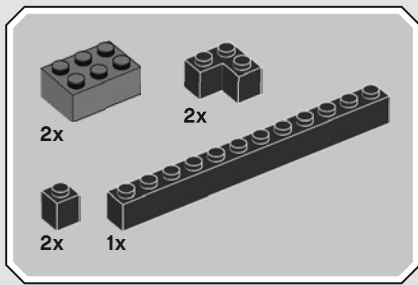

95

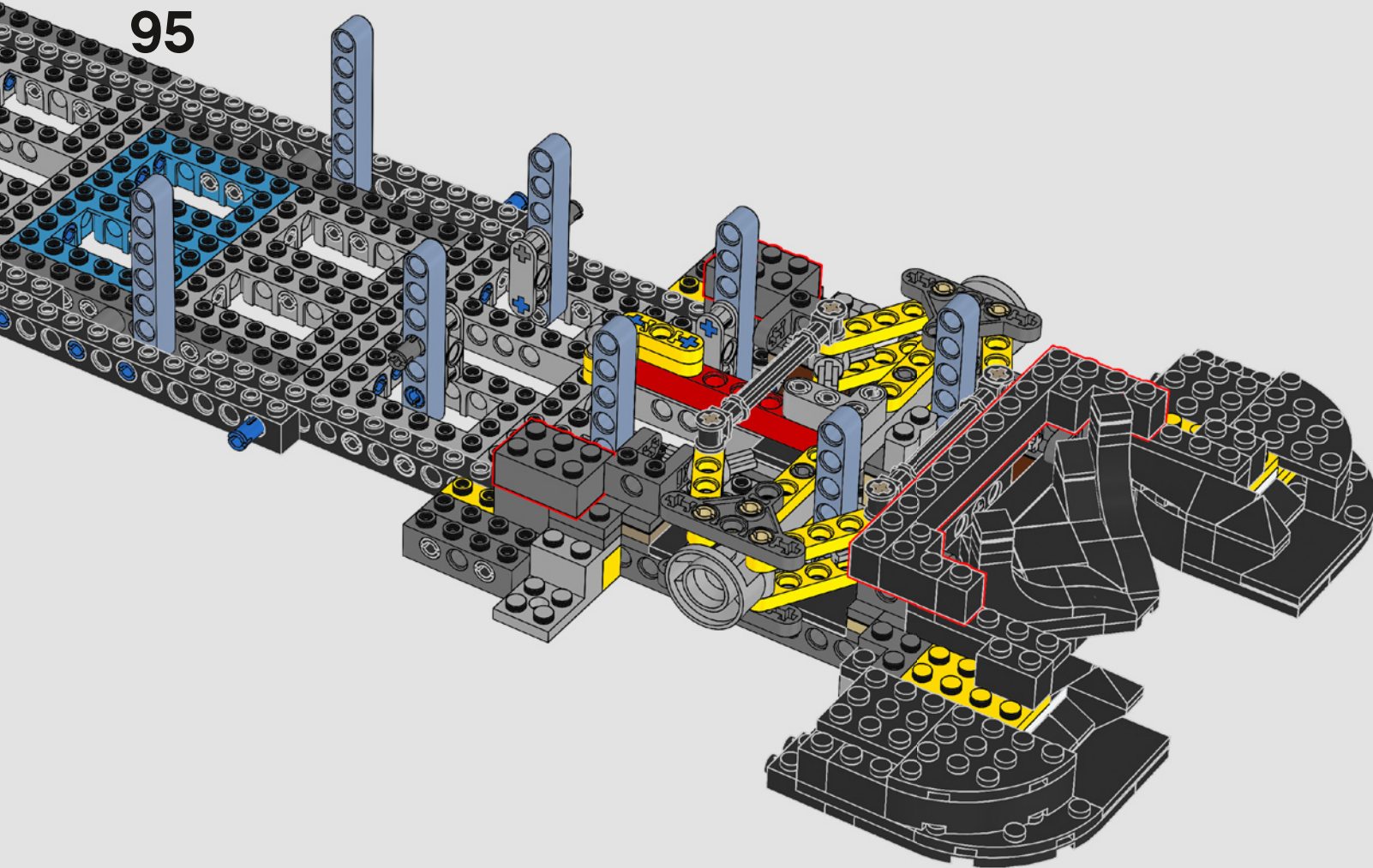

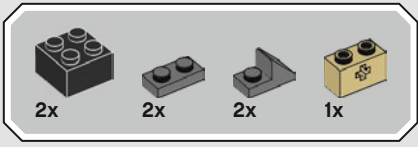

96

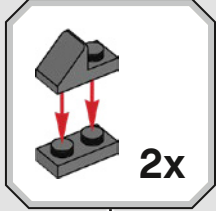
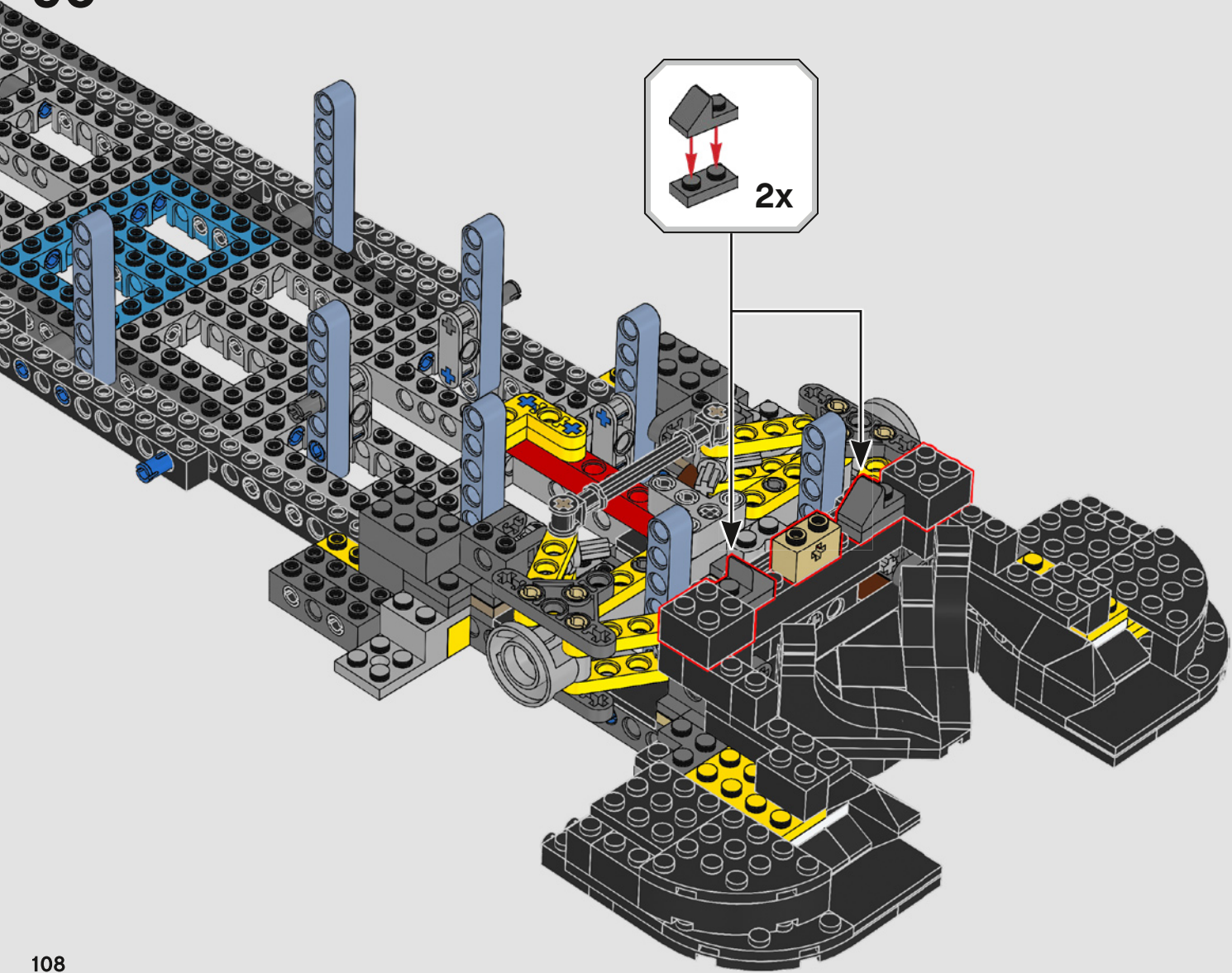

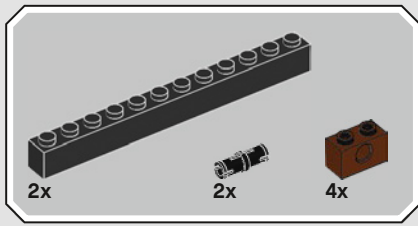

97

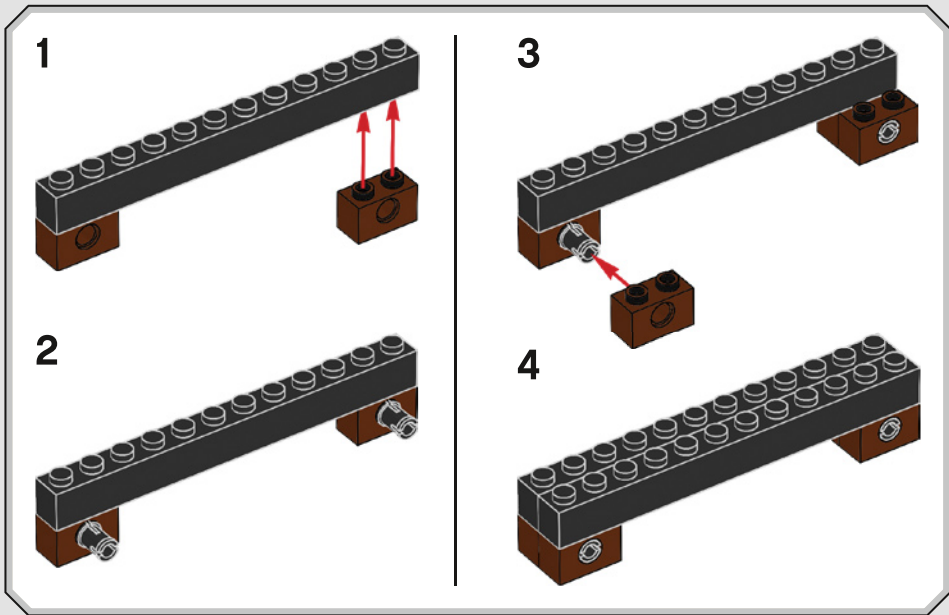
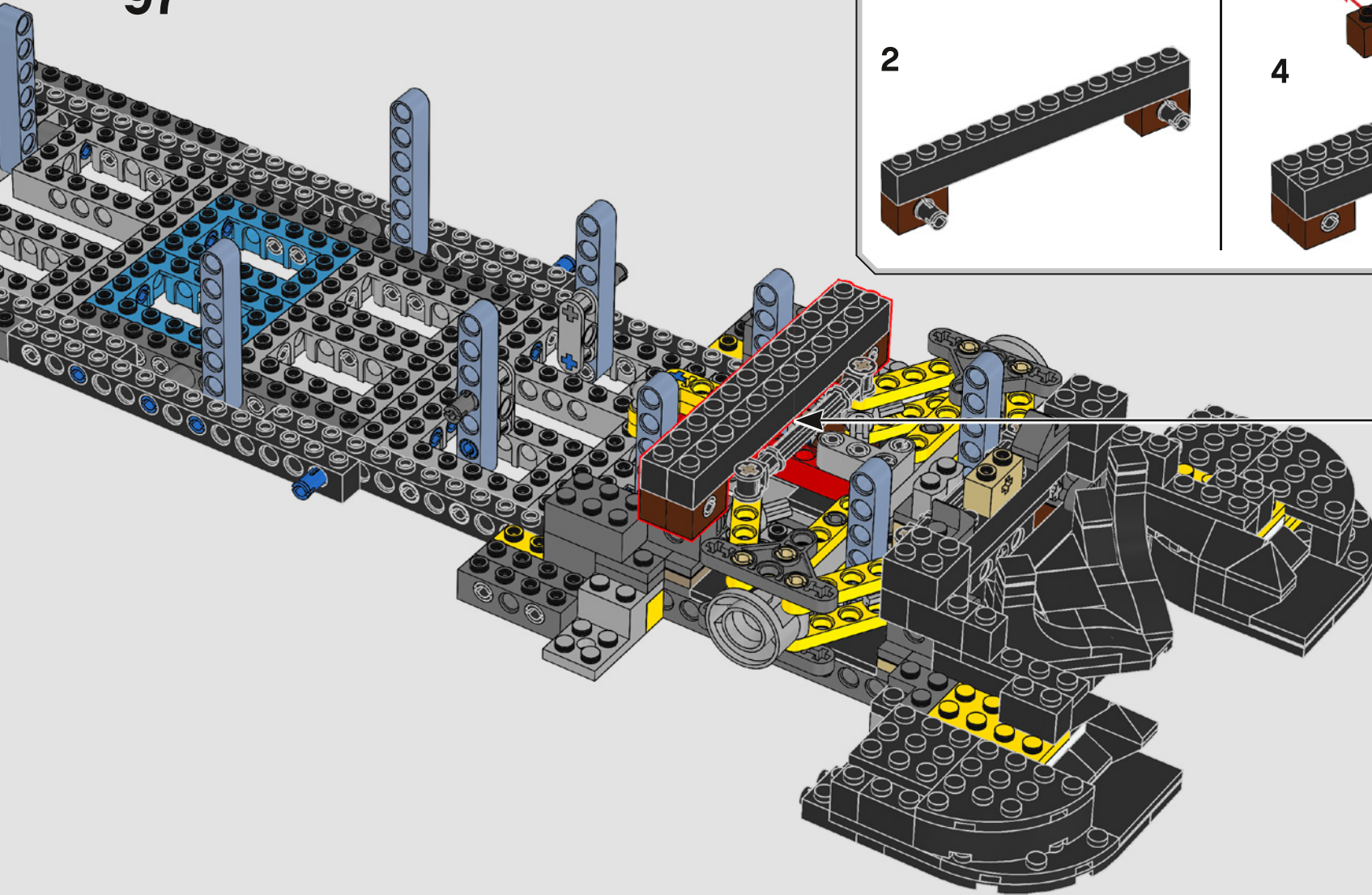

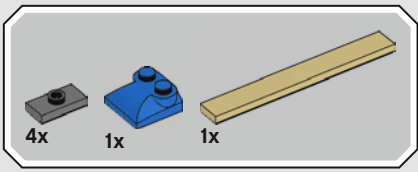

98

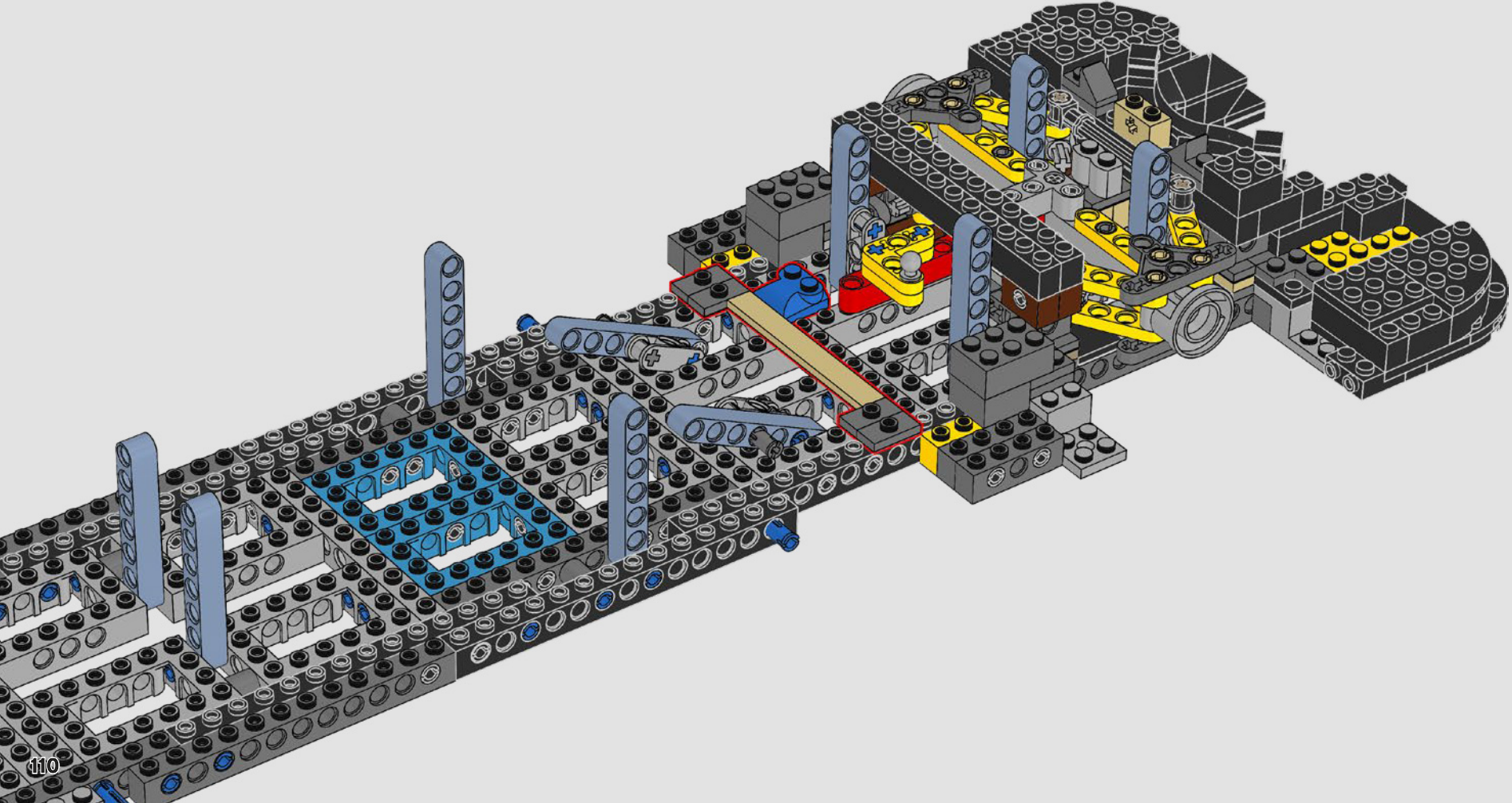

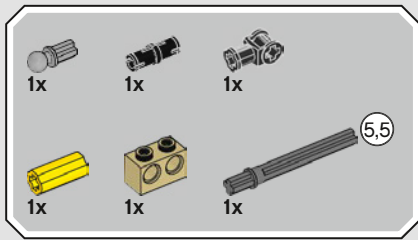

99

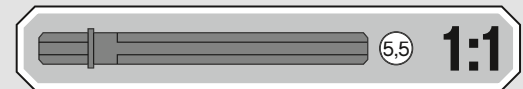
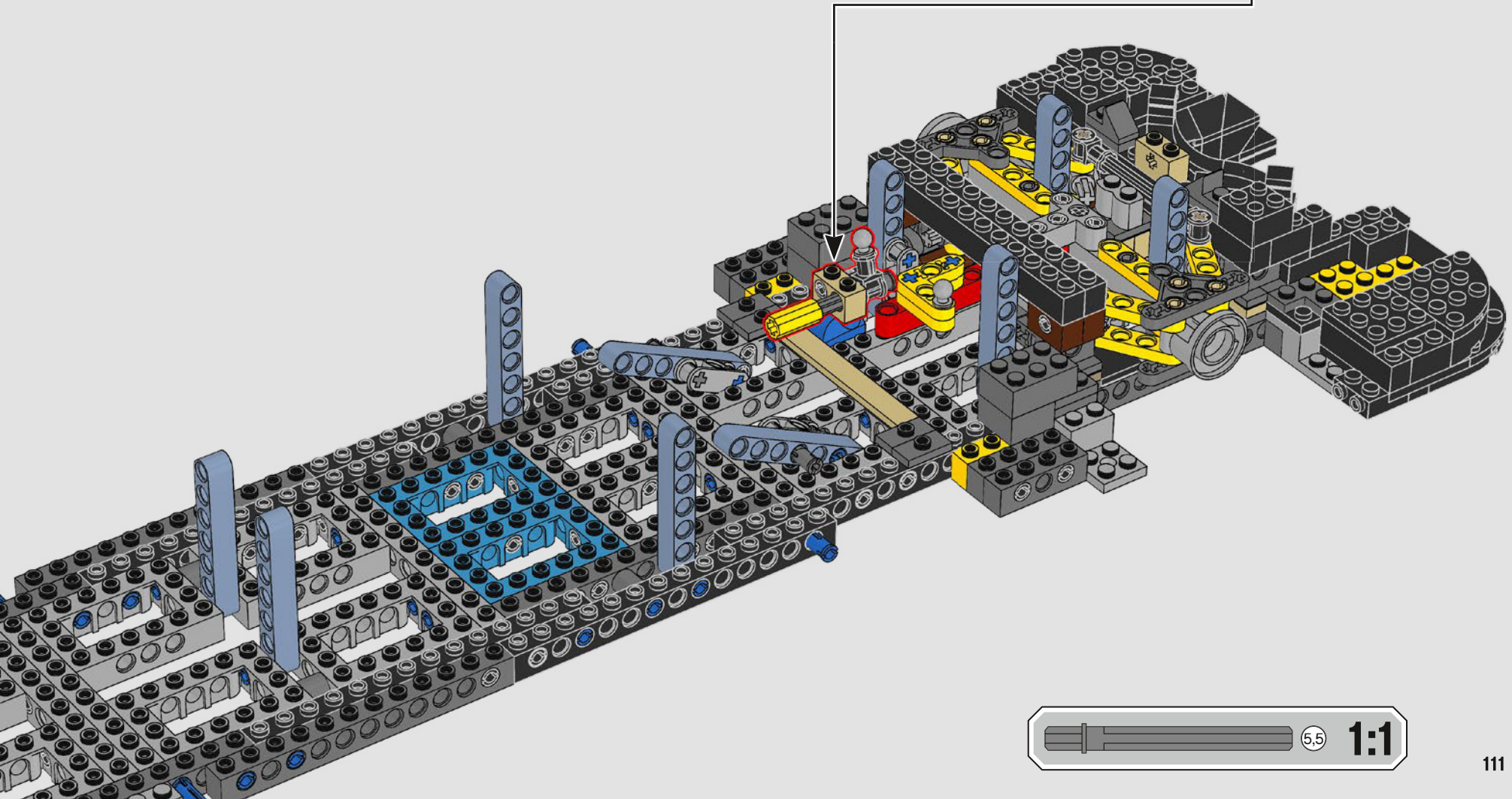
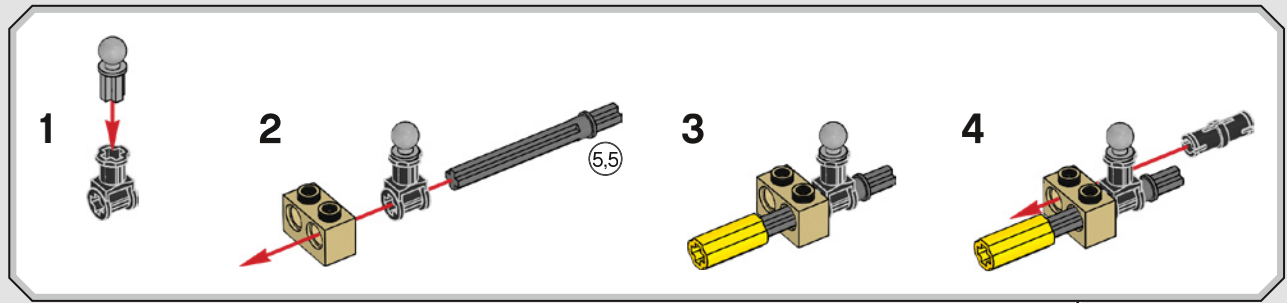

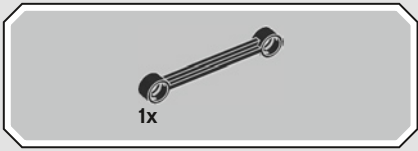

100

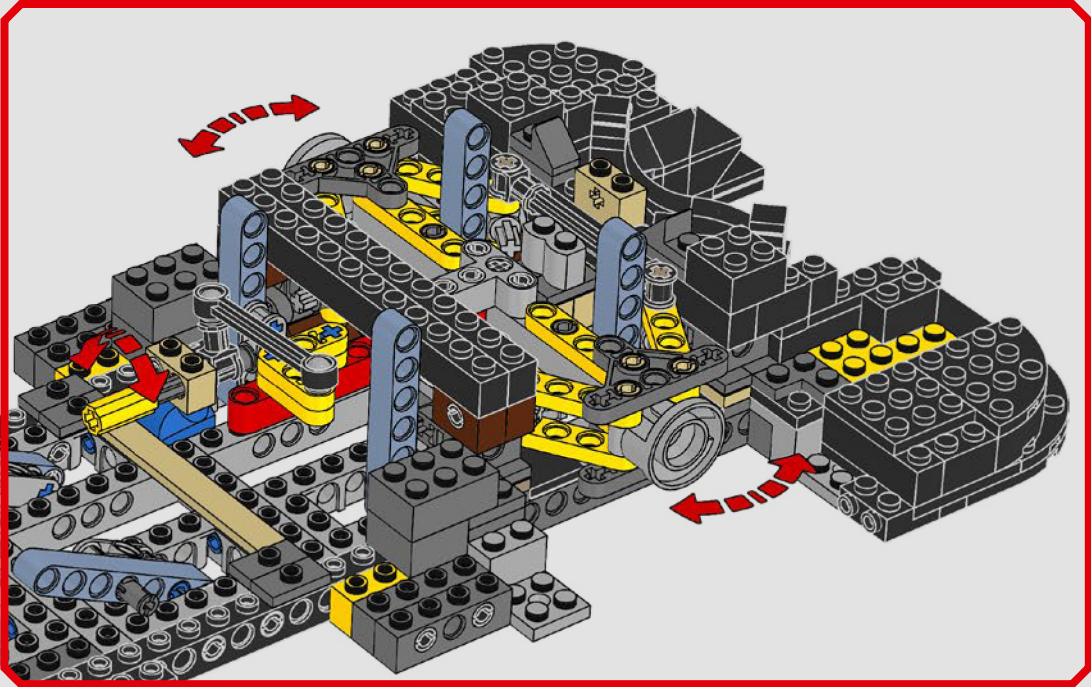
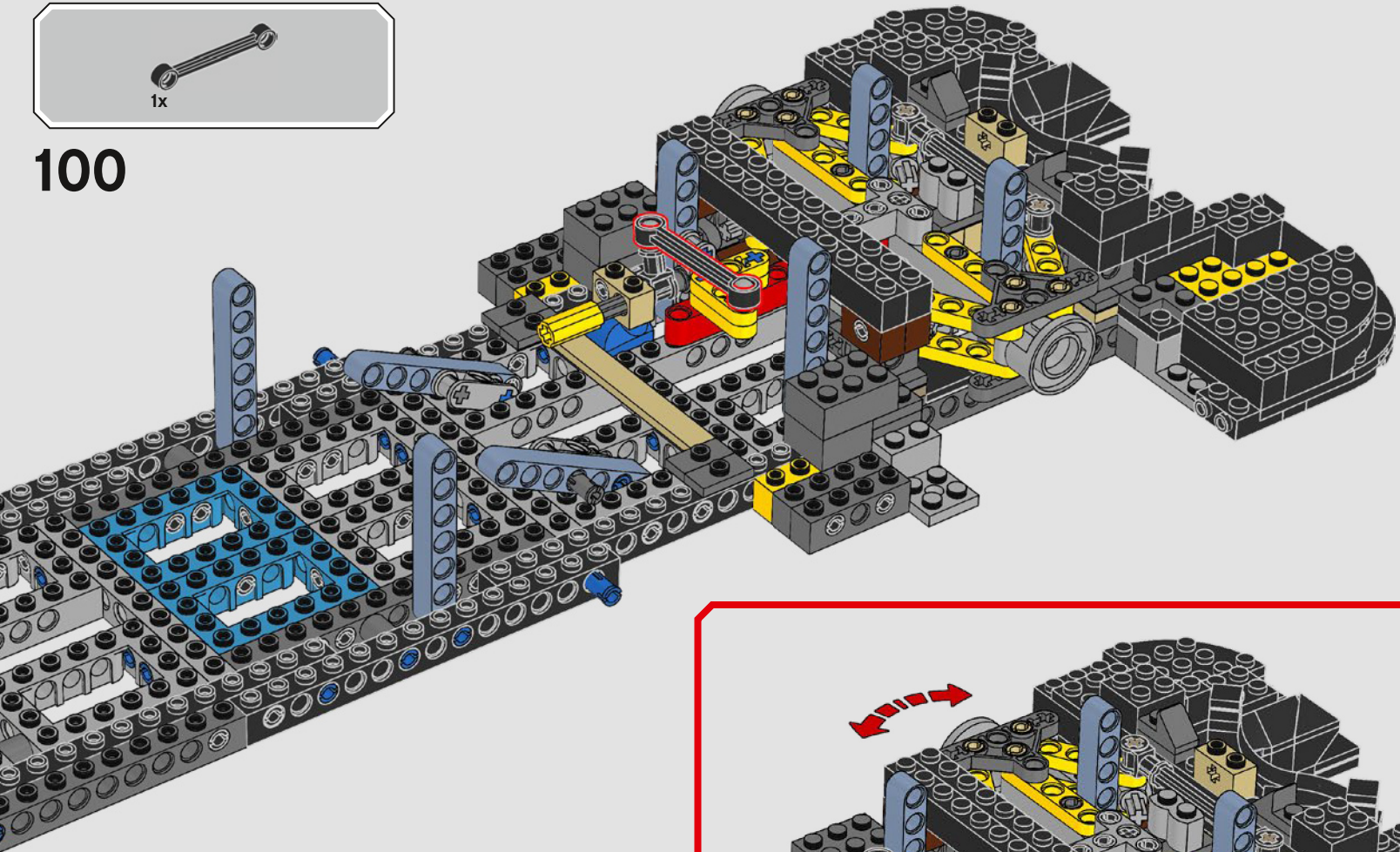



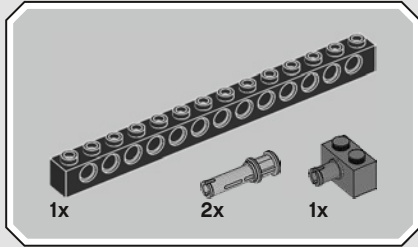
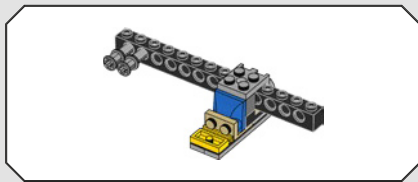

101

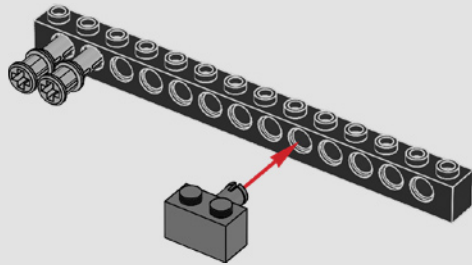

102

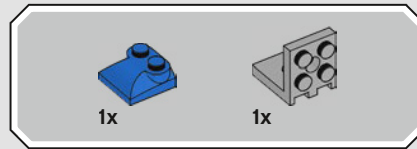
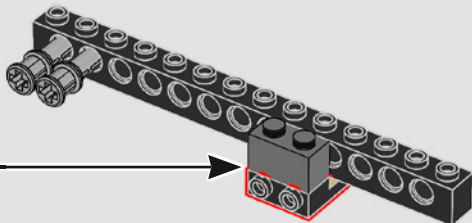
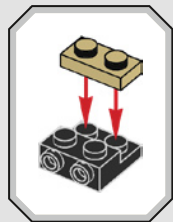

103

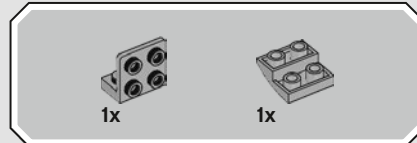
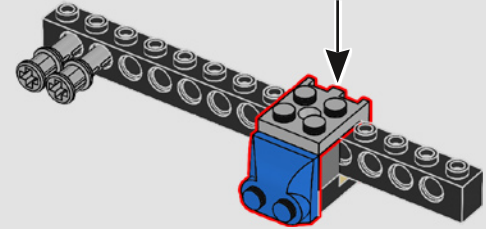
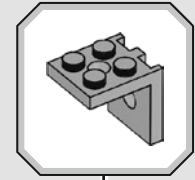

104

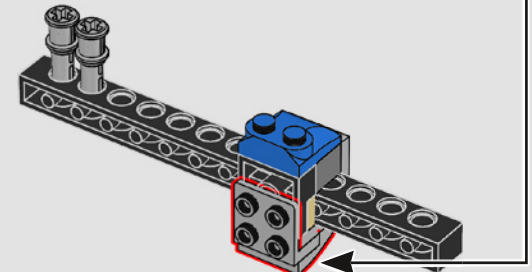
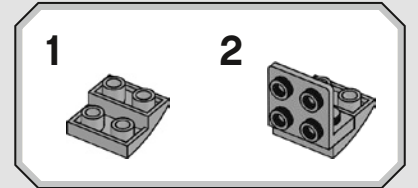

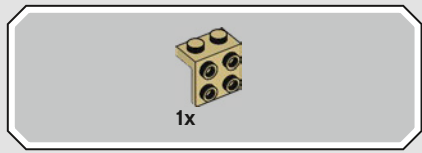

105

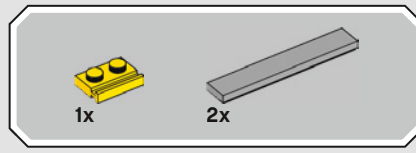
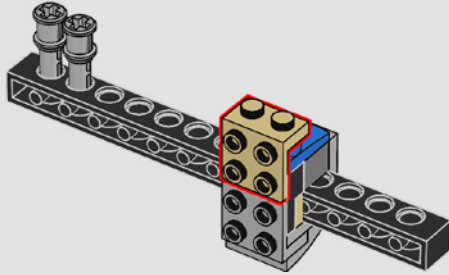

106

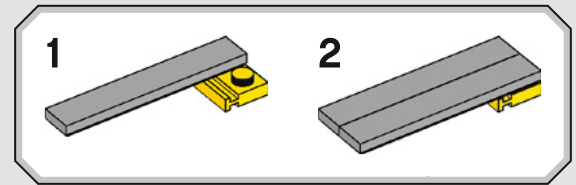
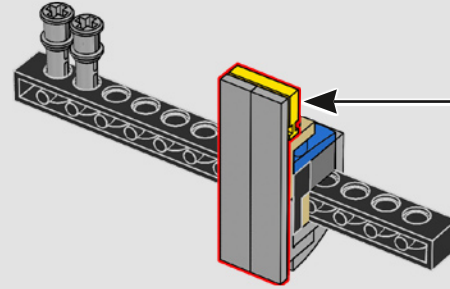

107

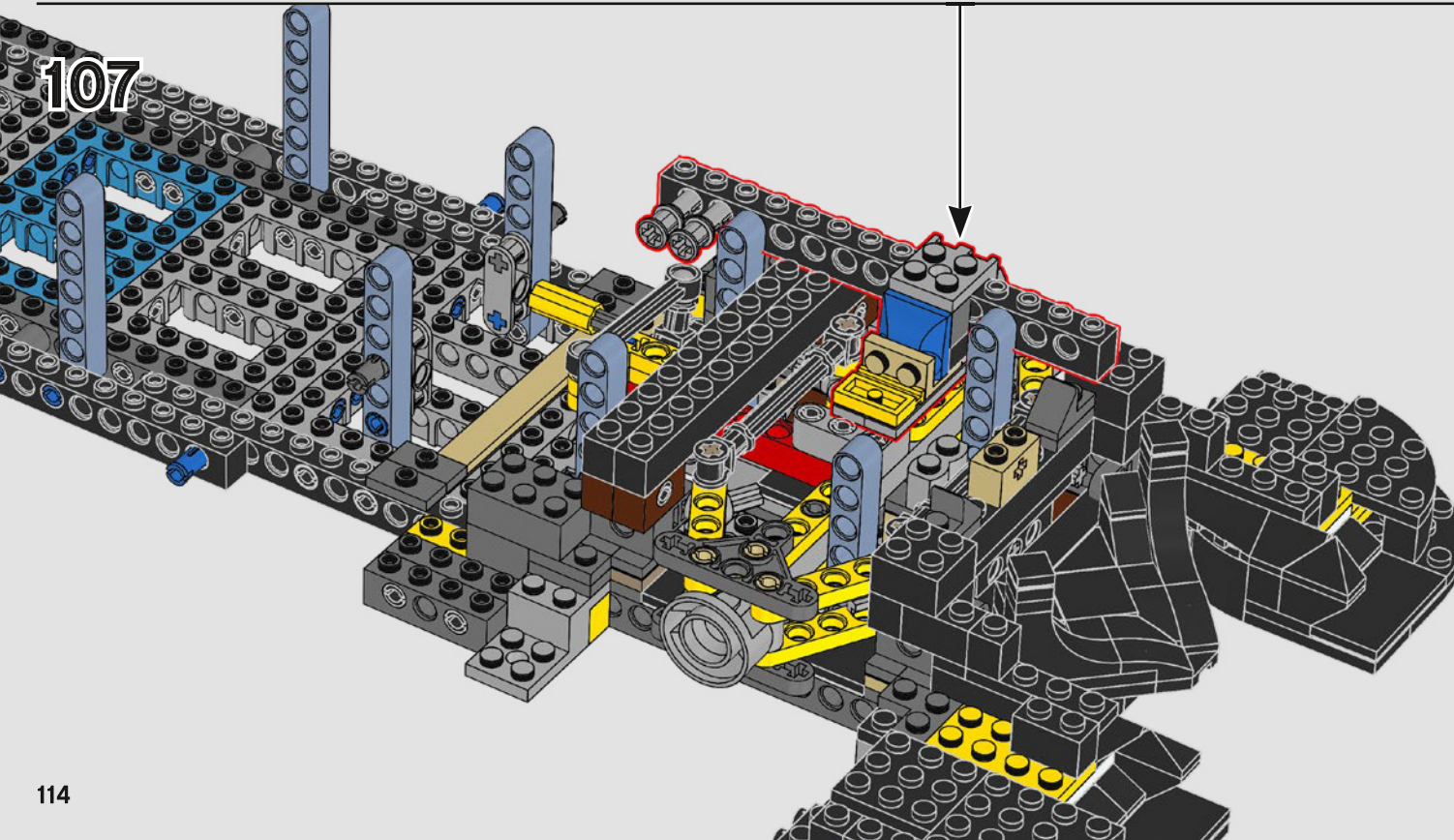

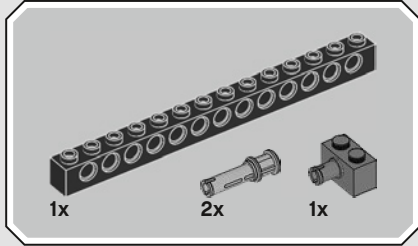
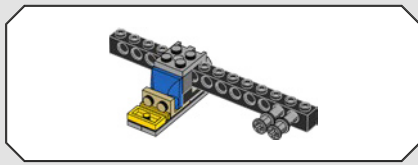

108

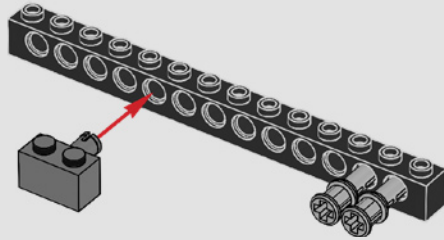

109

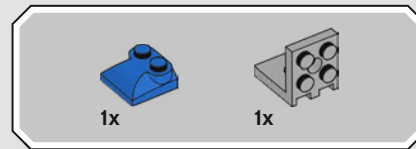
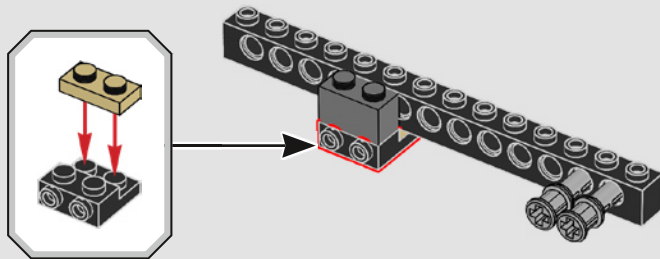

110

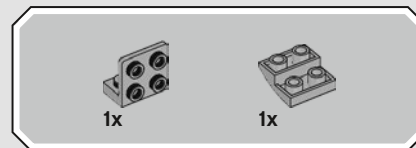
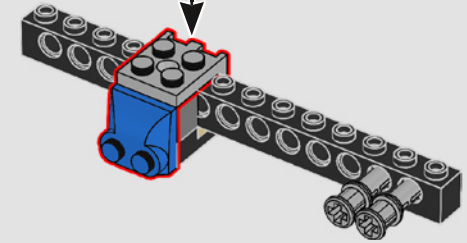
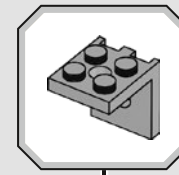

111

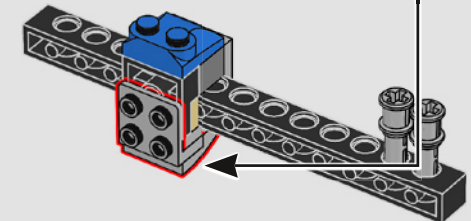
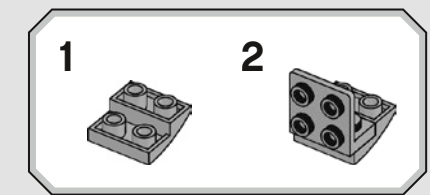

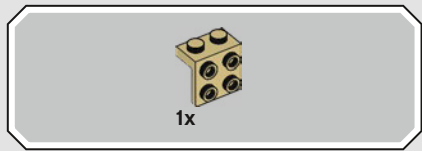

112

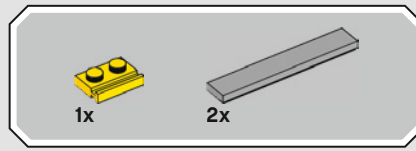
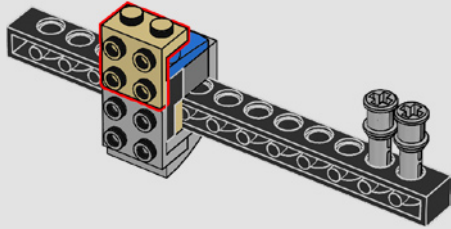

113

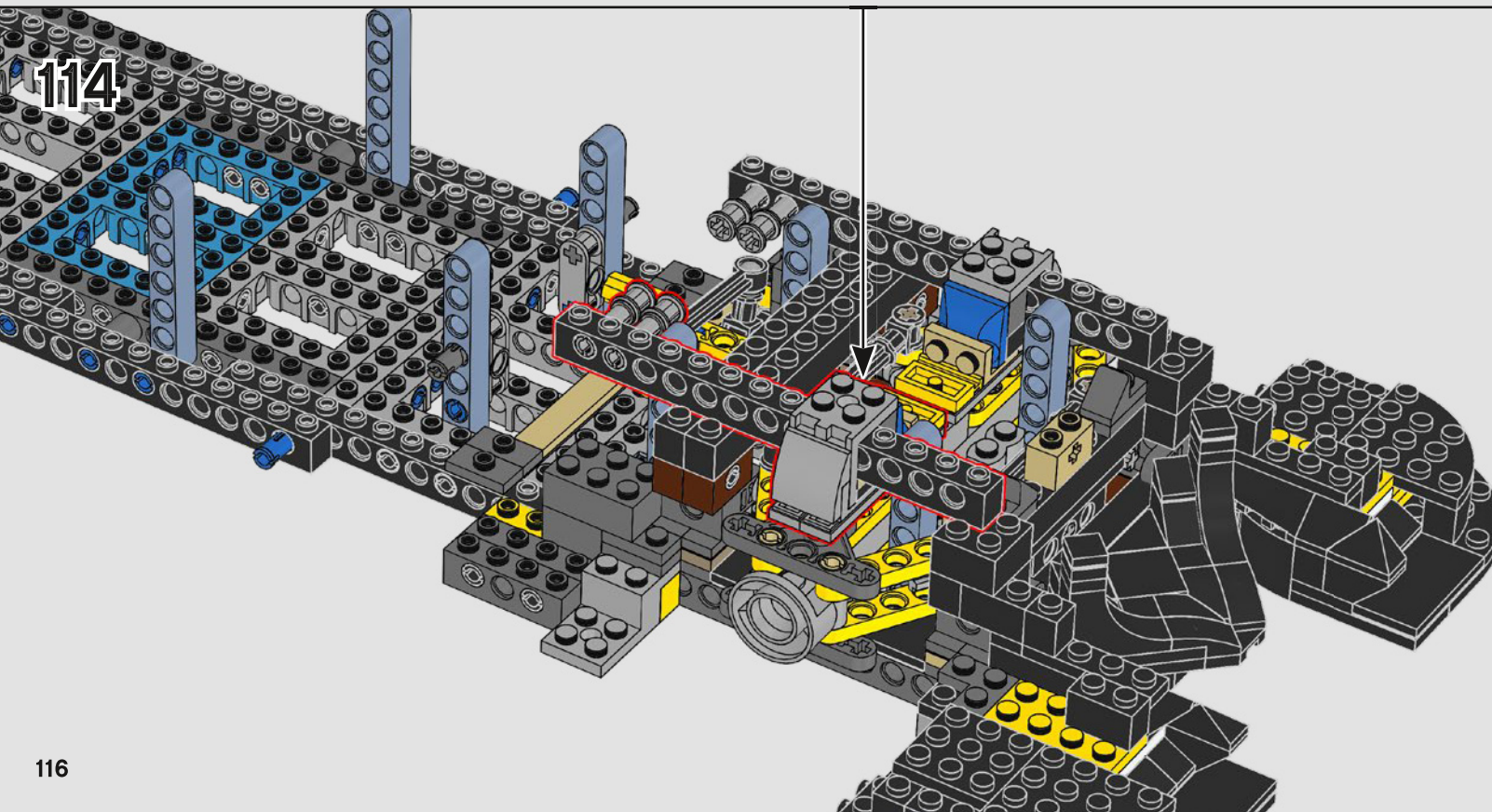
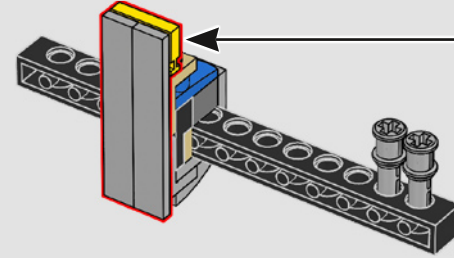
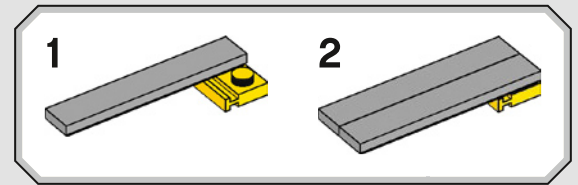

114

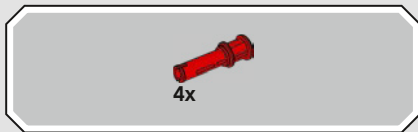

115

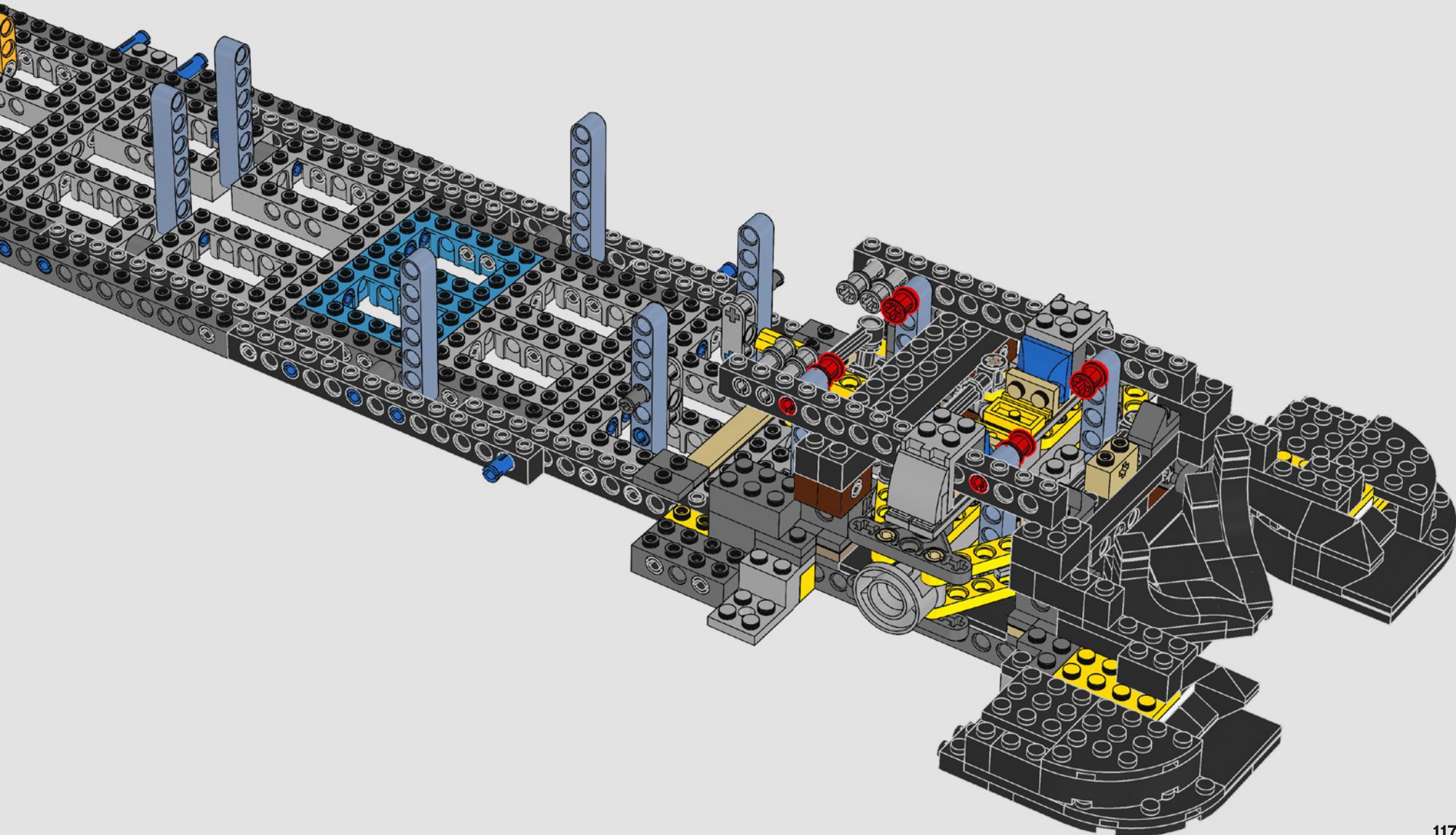

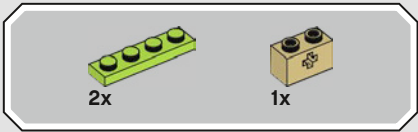

116

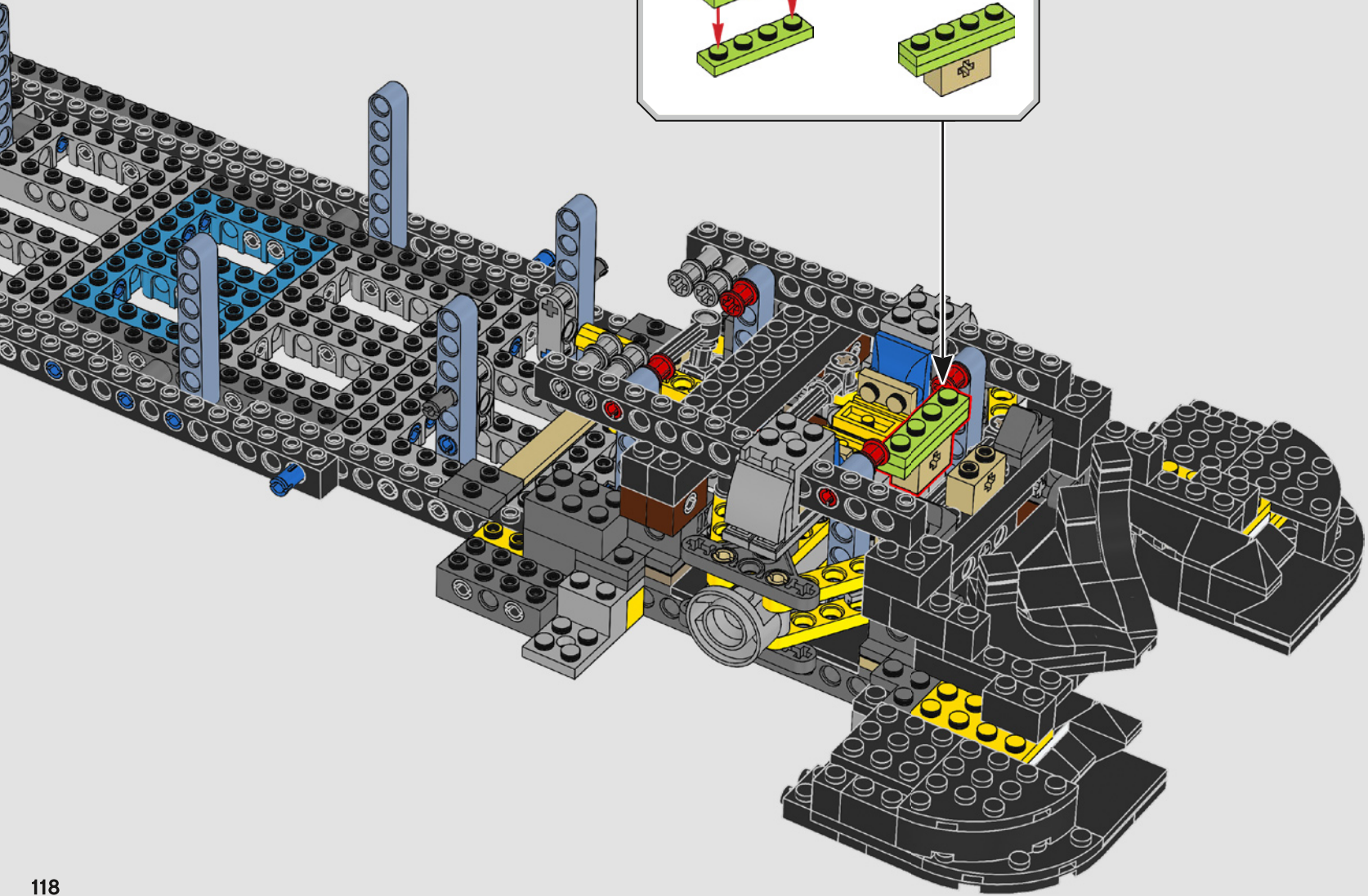
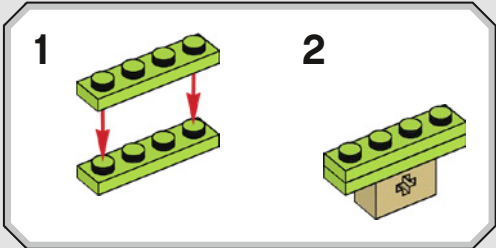

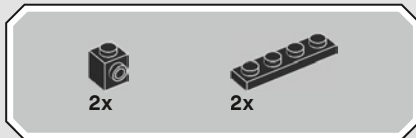
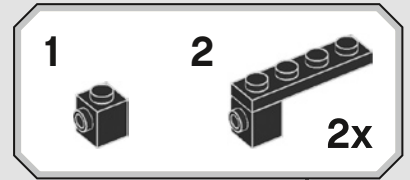
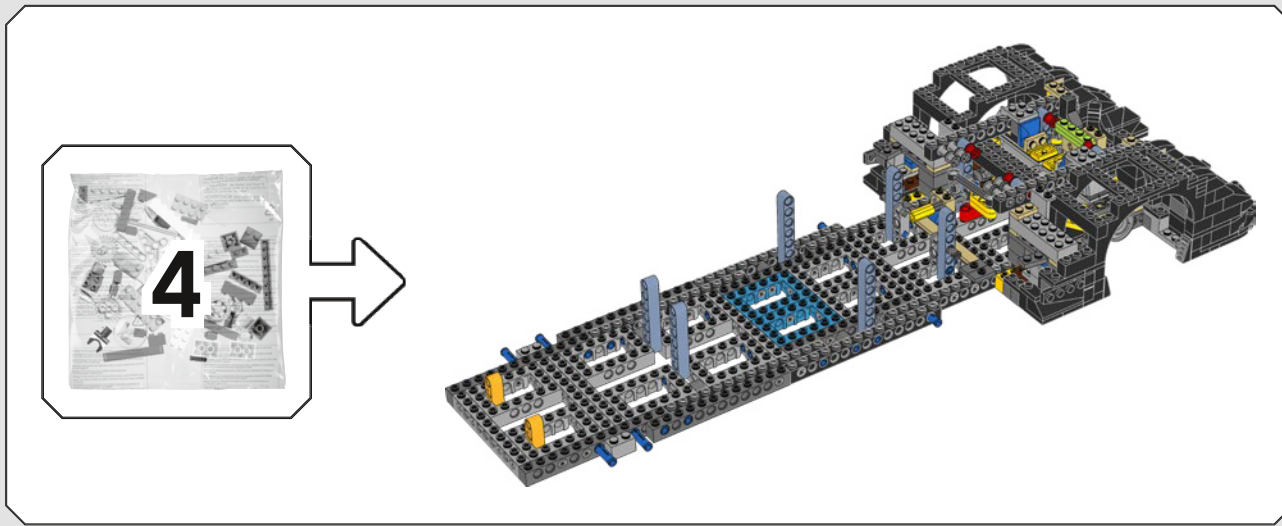

117

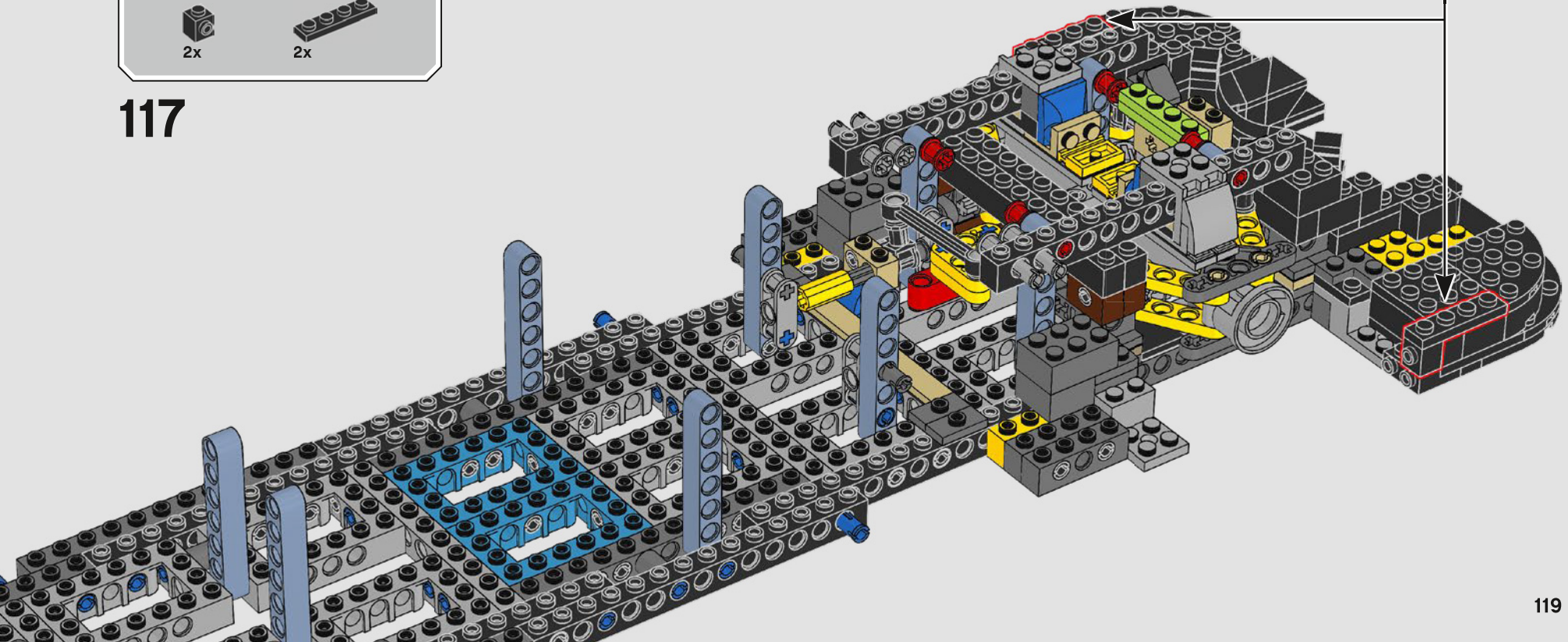

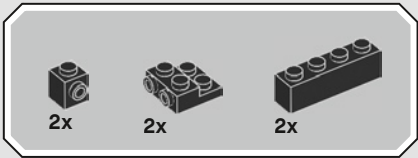

118

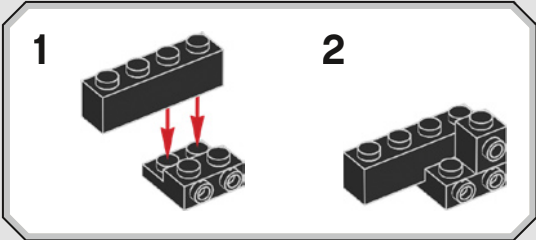

2

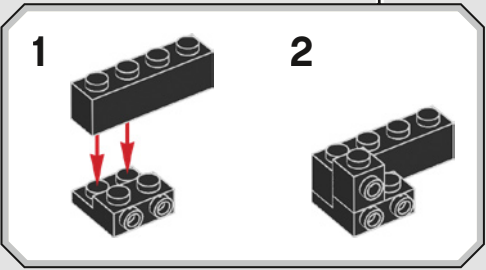
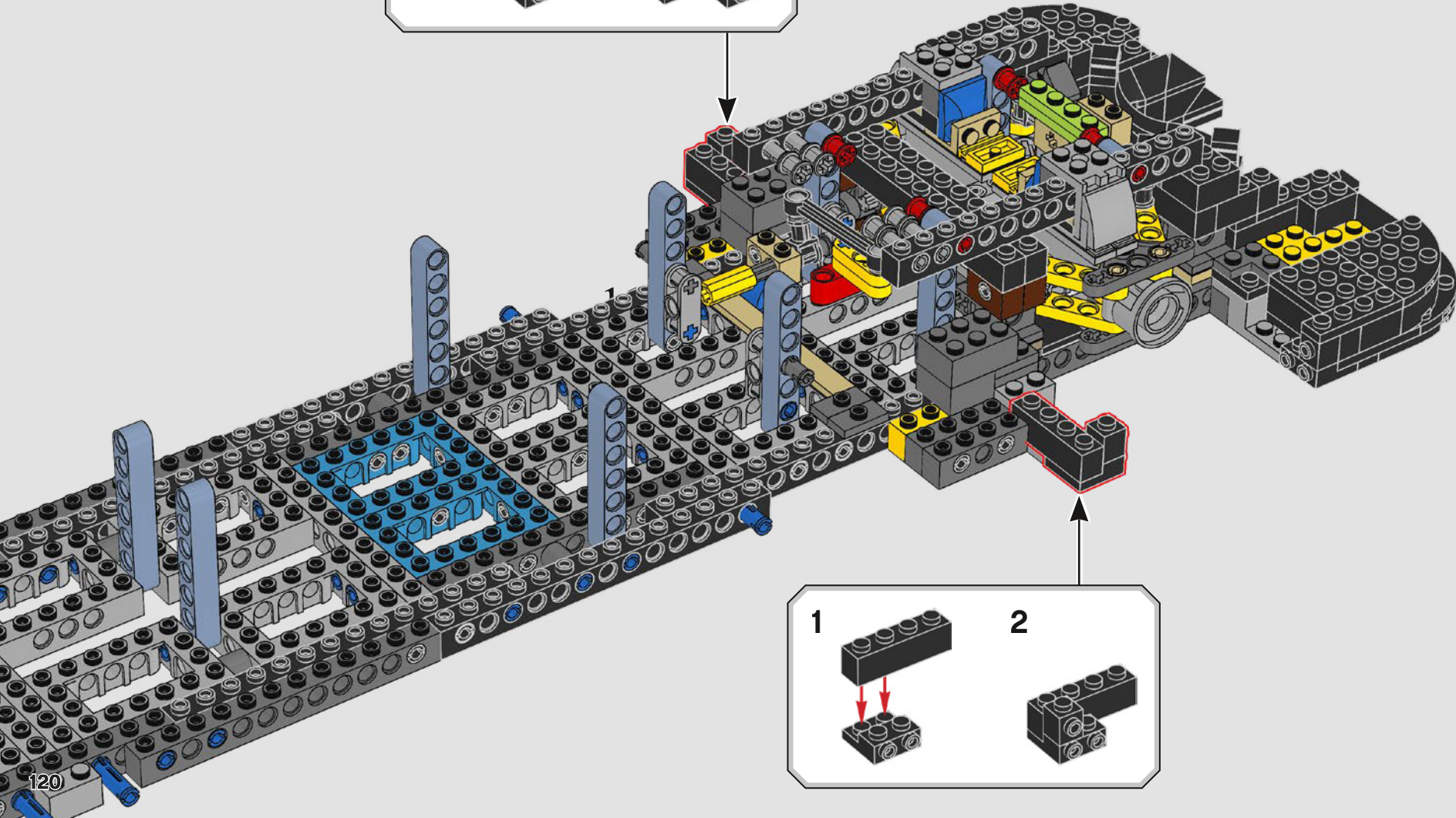

2



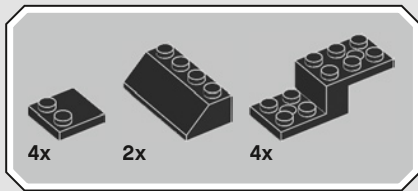

119

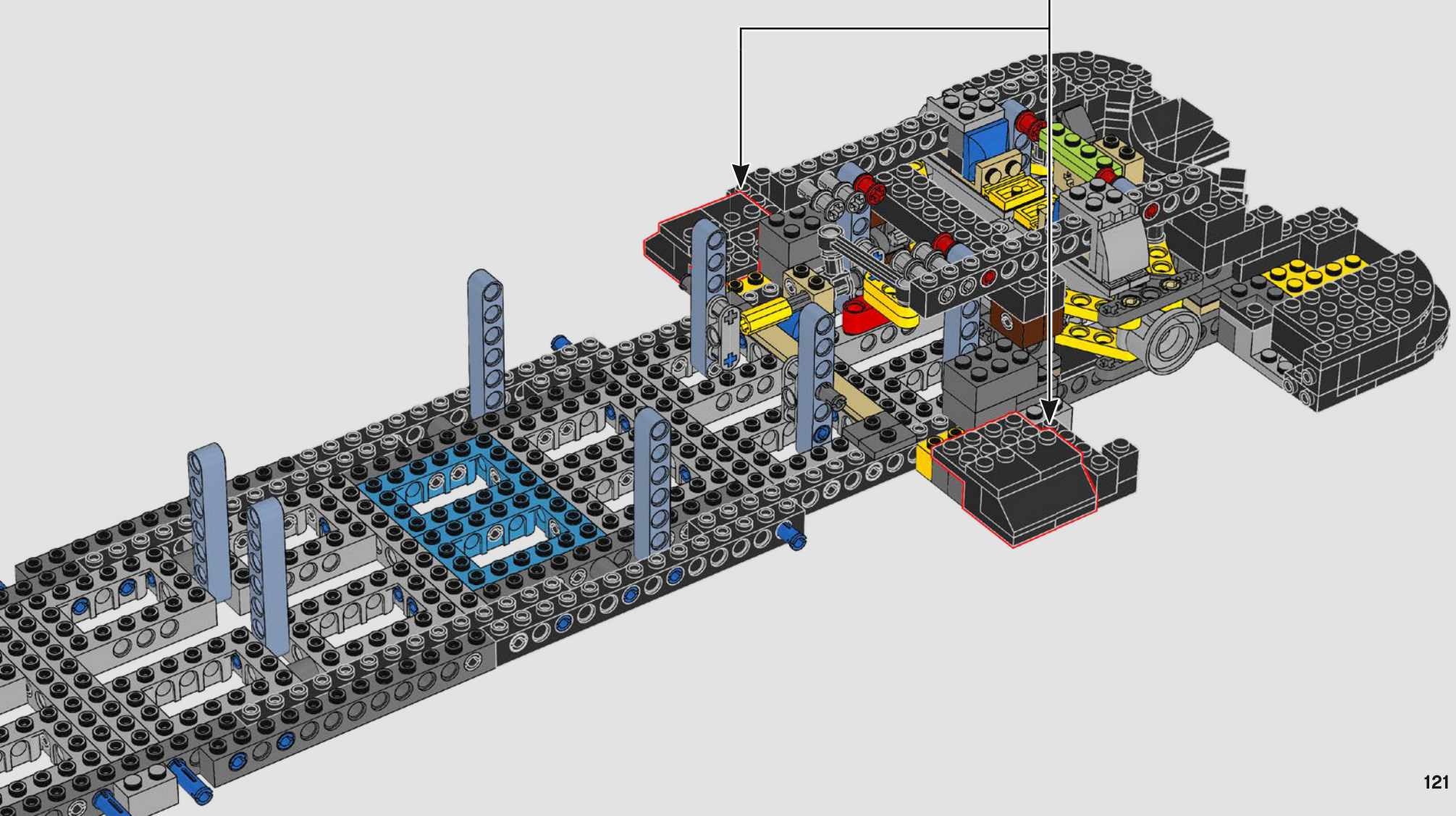
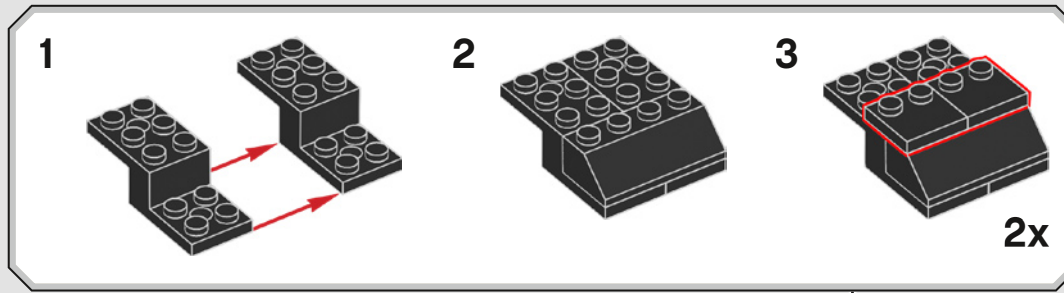

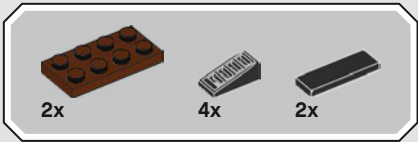



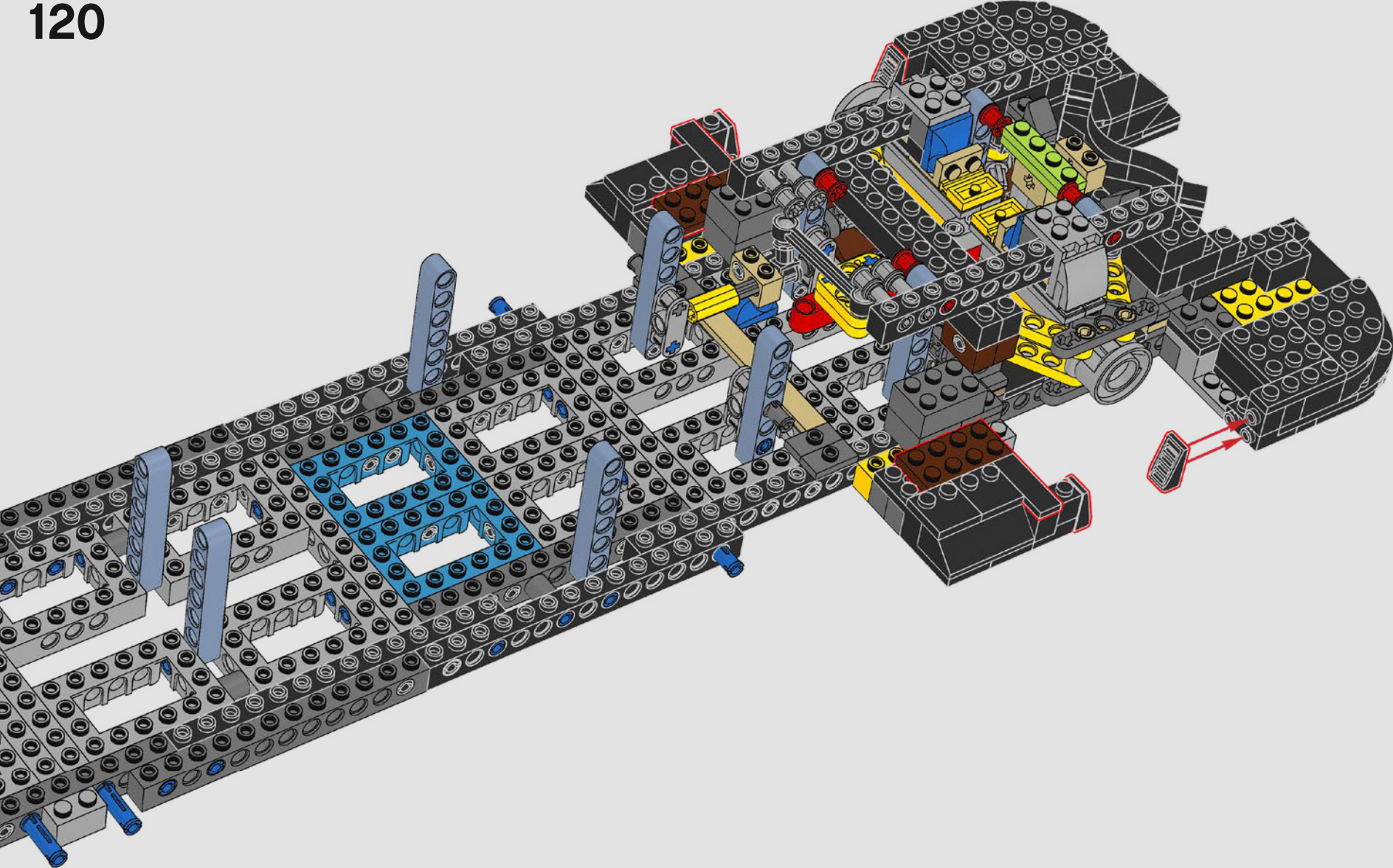

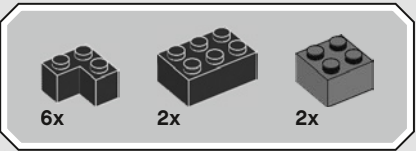
120



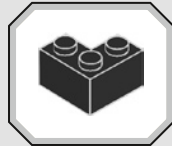

121



-   
4x
-   
2x
-   
1x
-   
1x

# 122

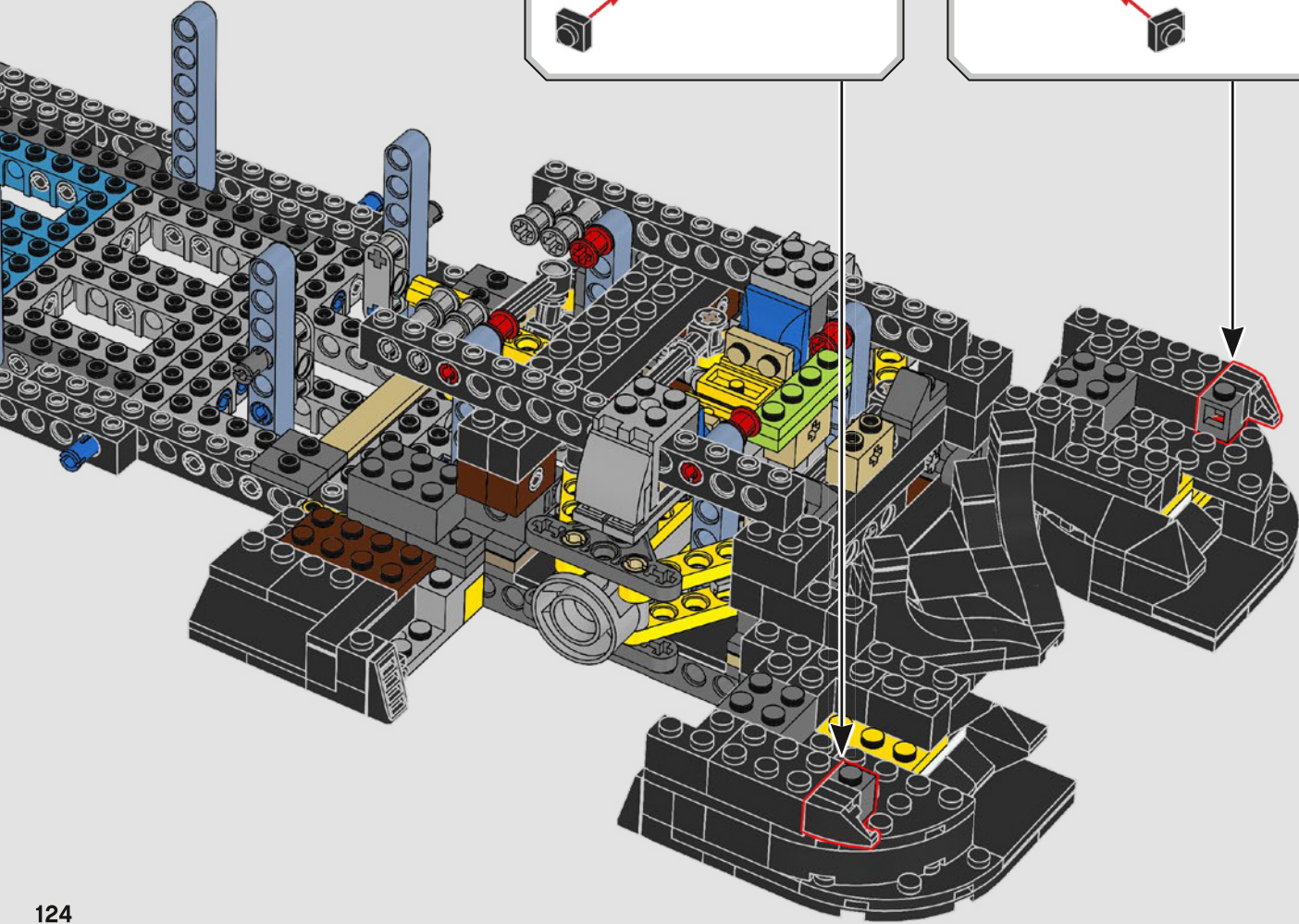
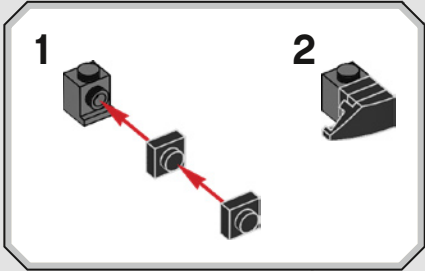
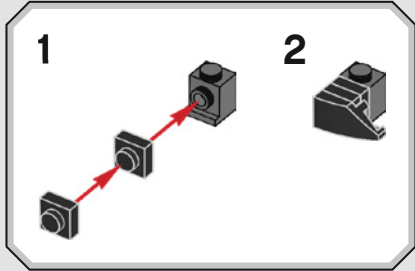

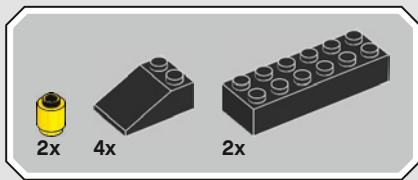

123

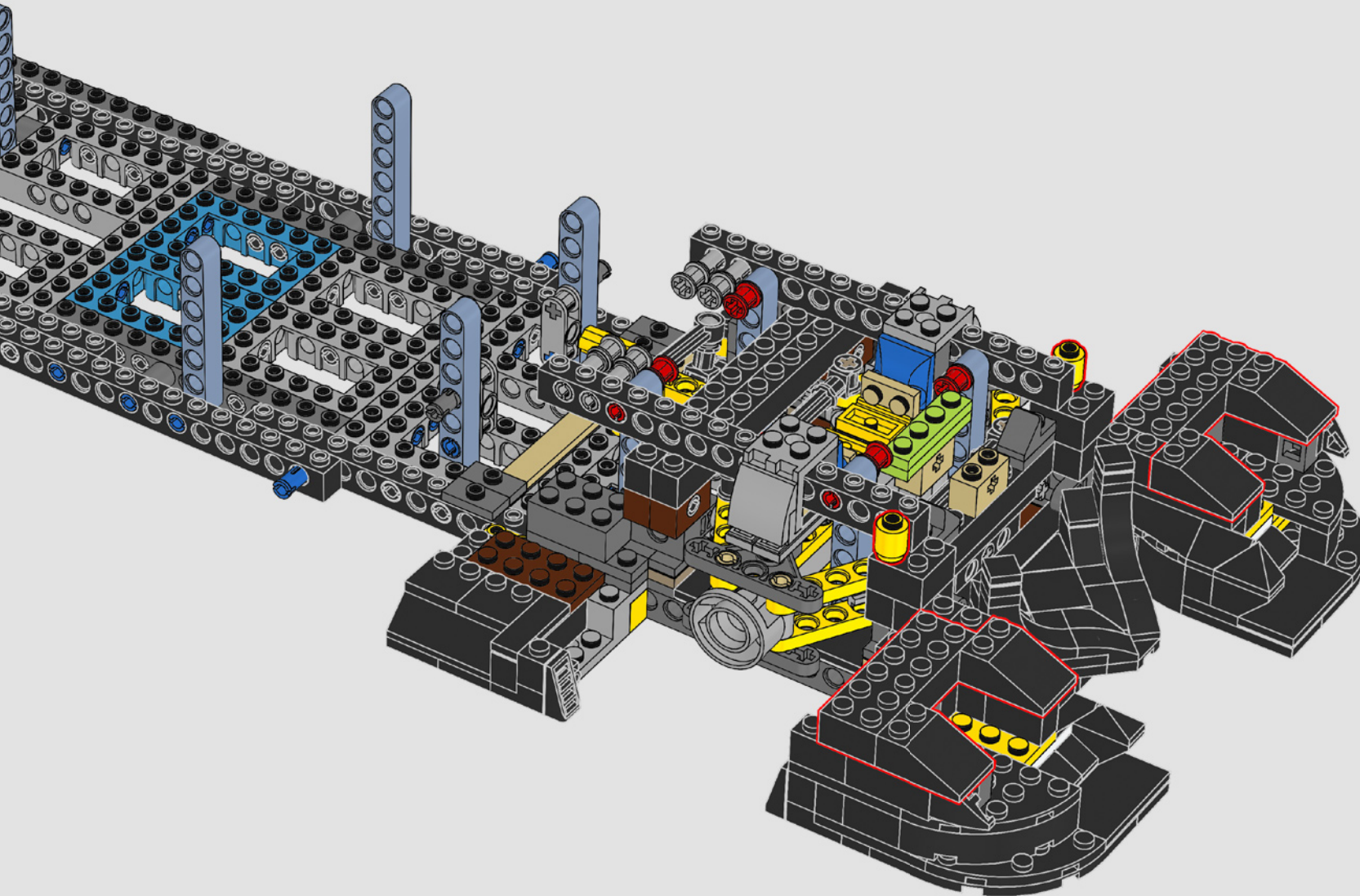

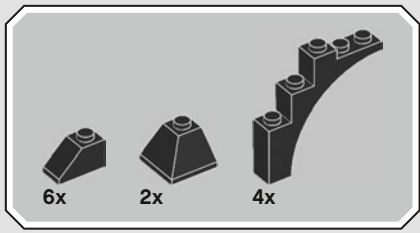

124

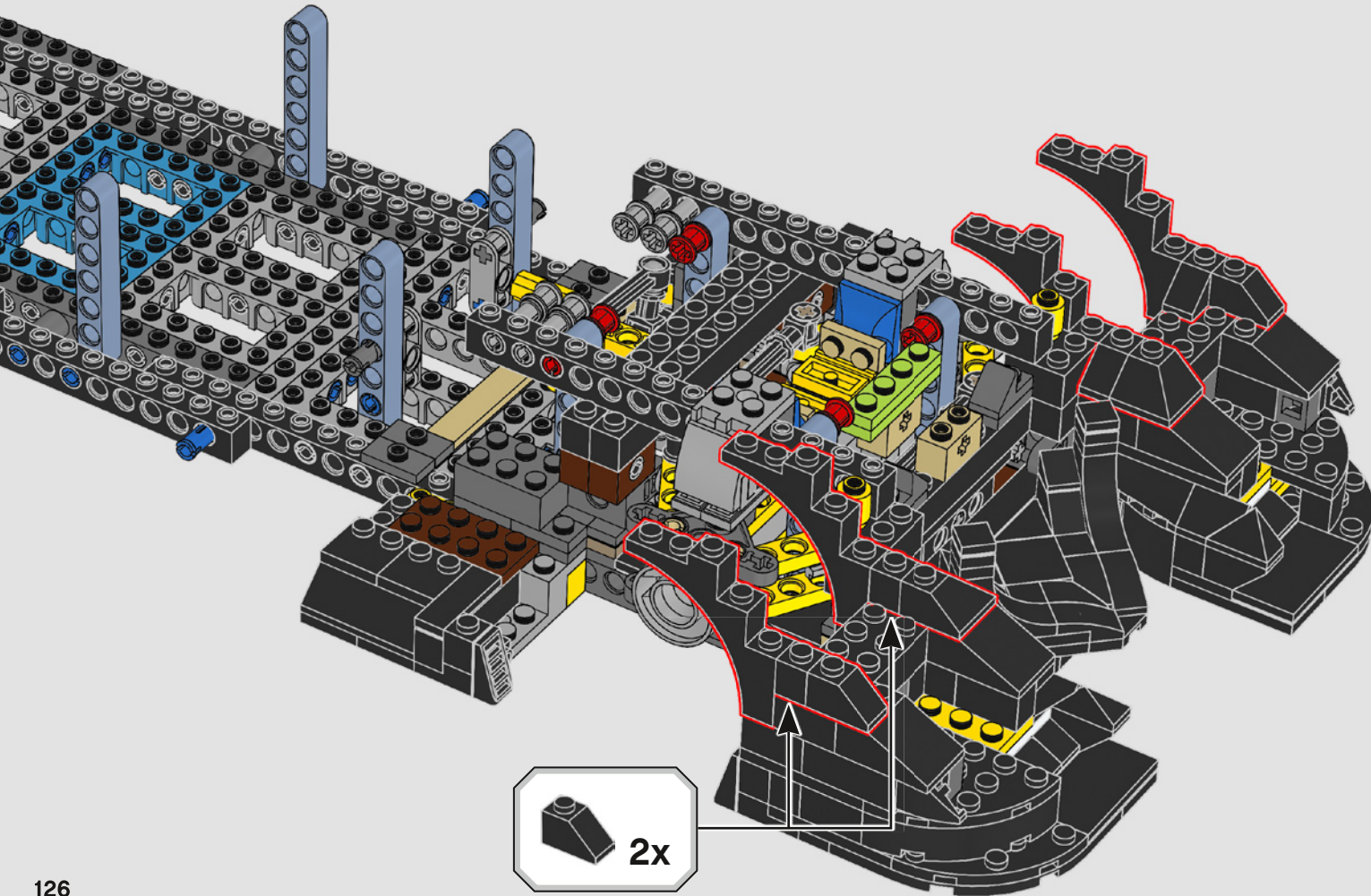

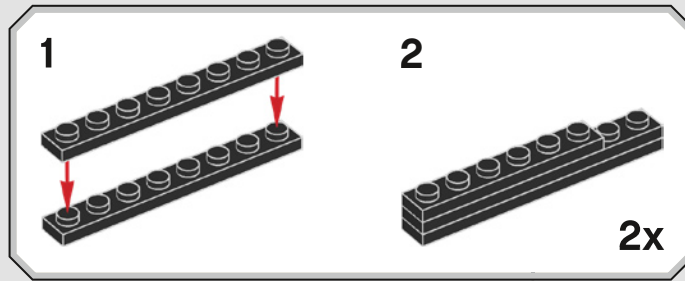
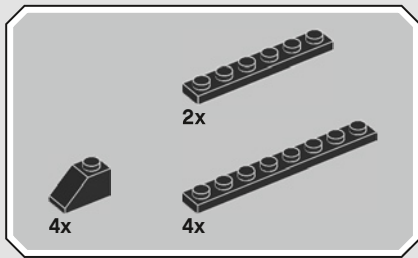

125

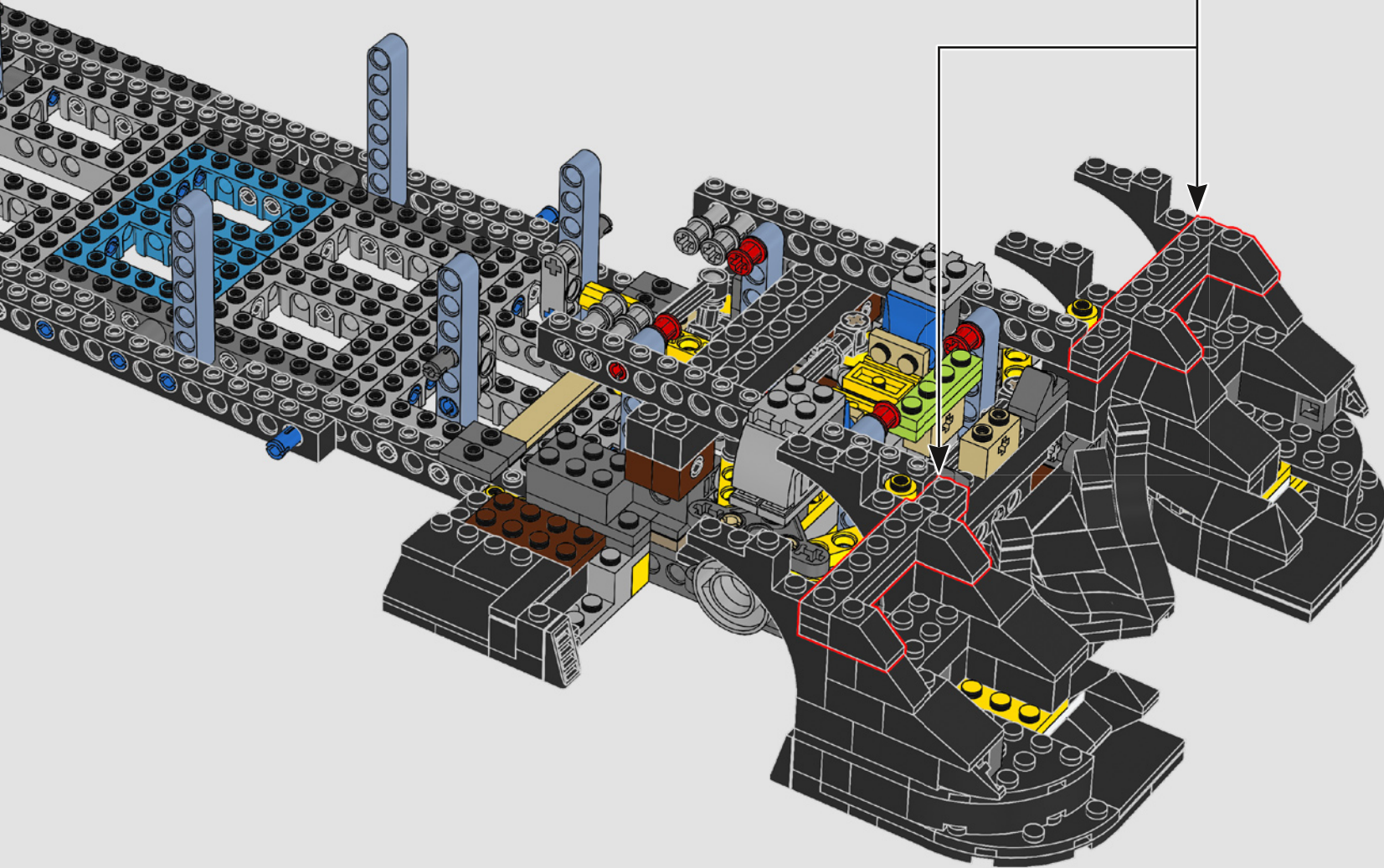

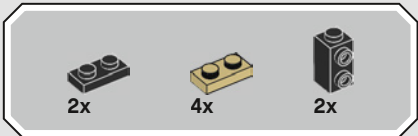

126

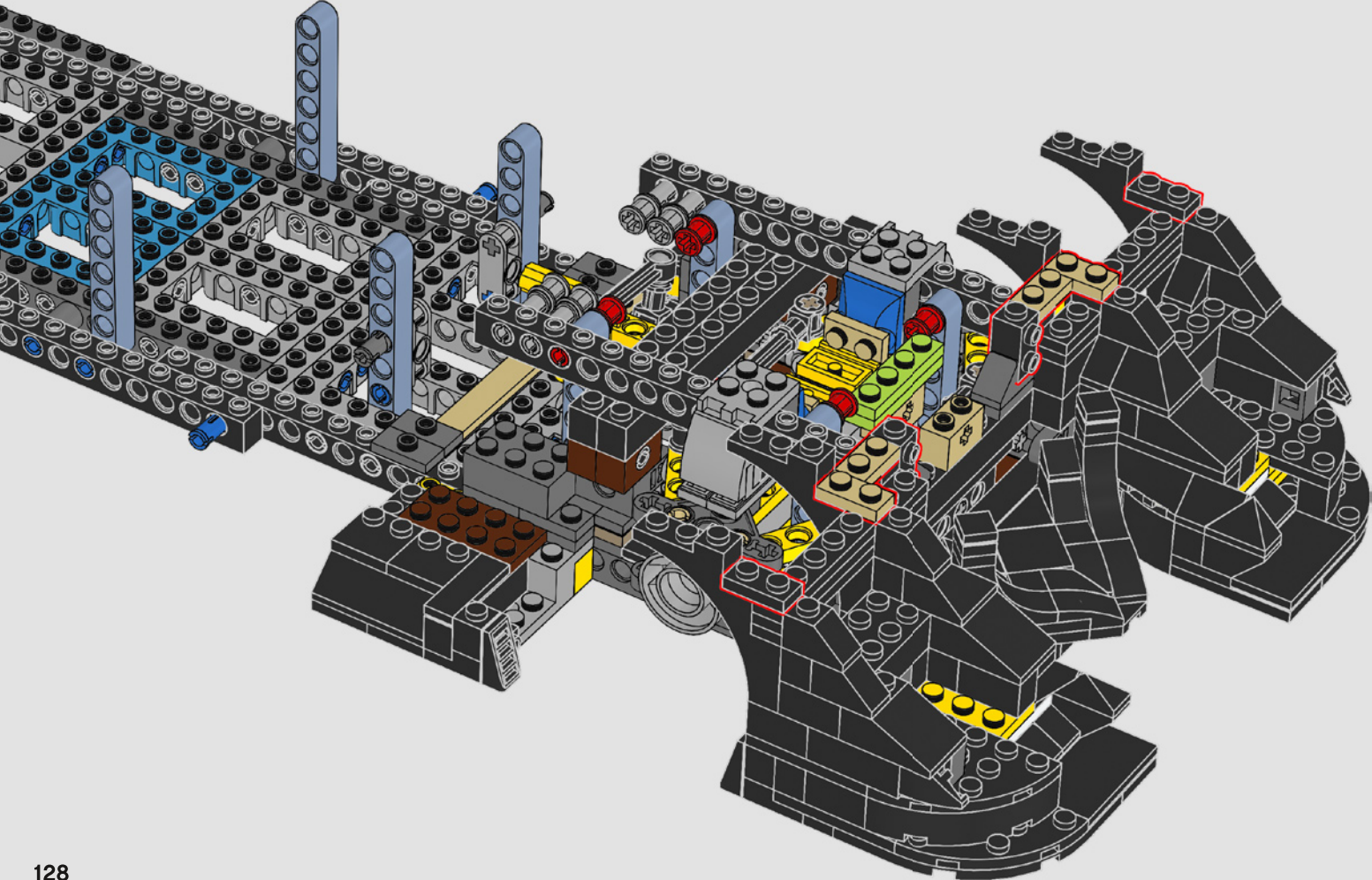



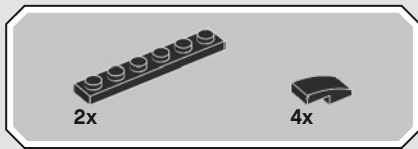

127

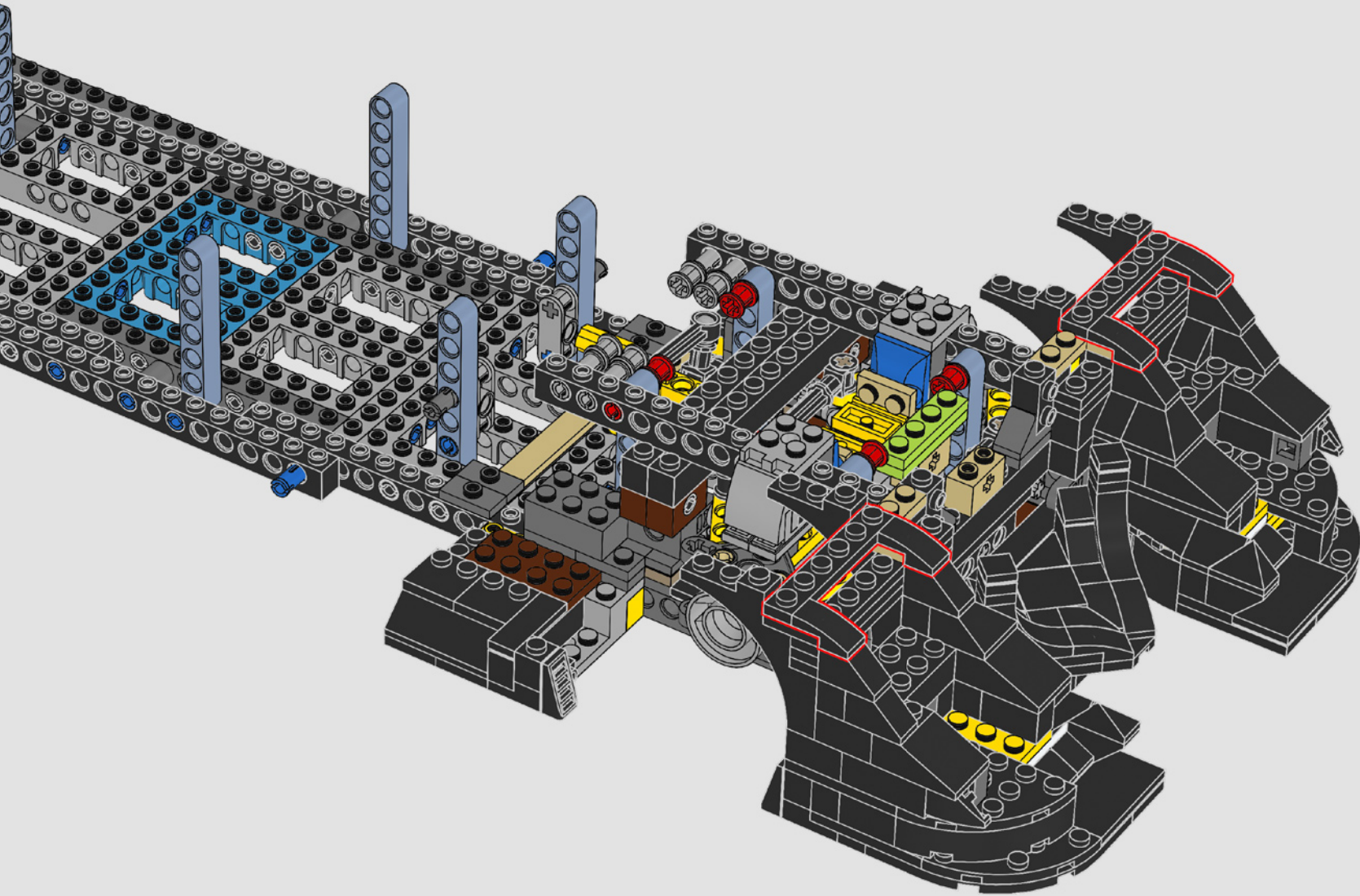

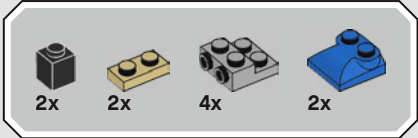

# 128

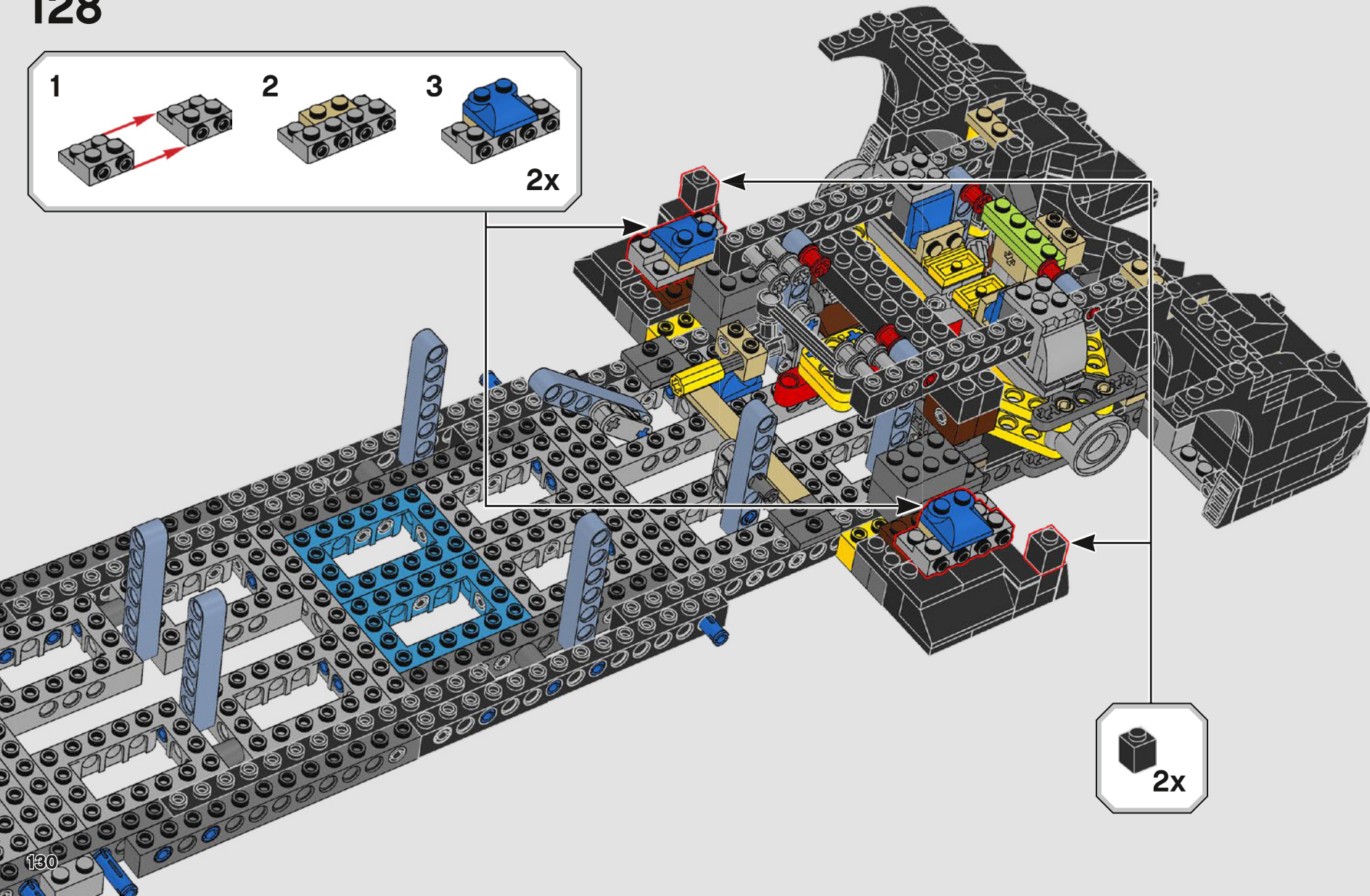
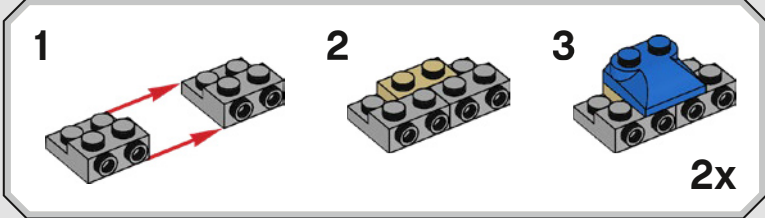

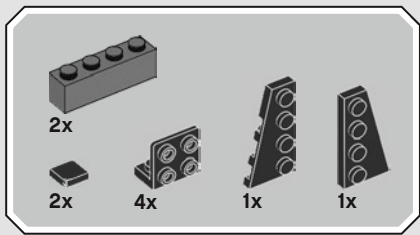

129

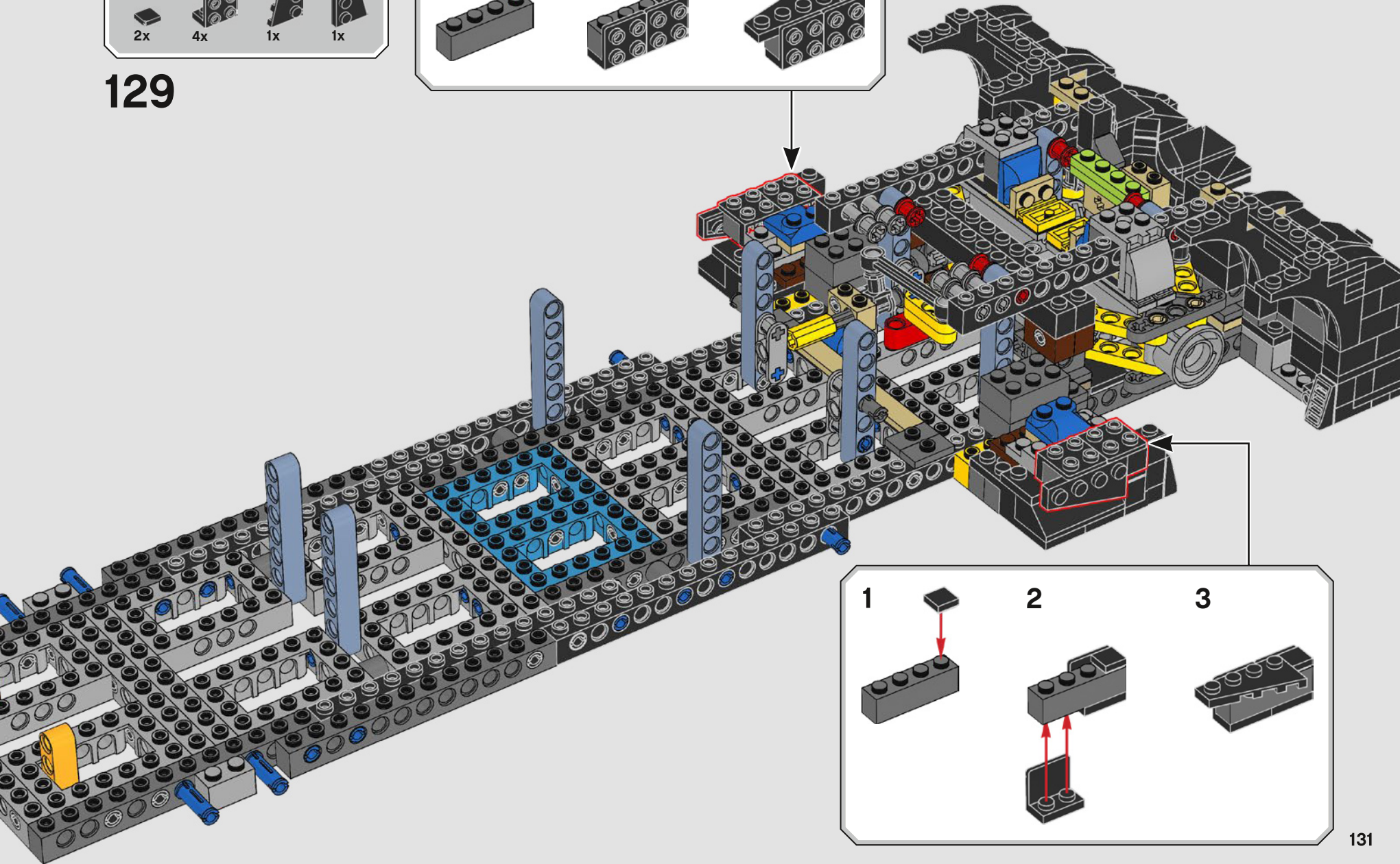
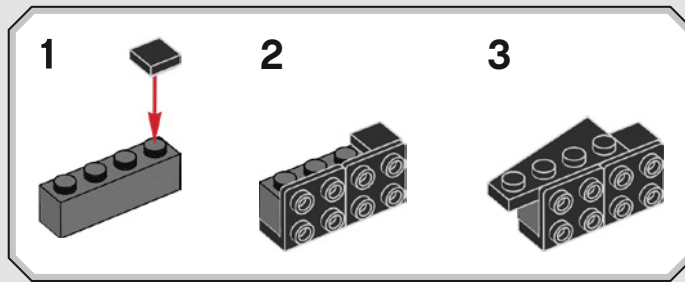

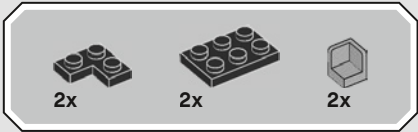

130

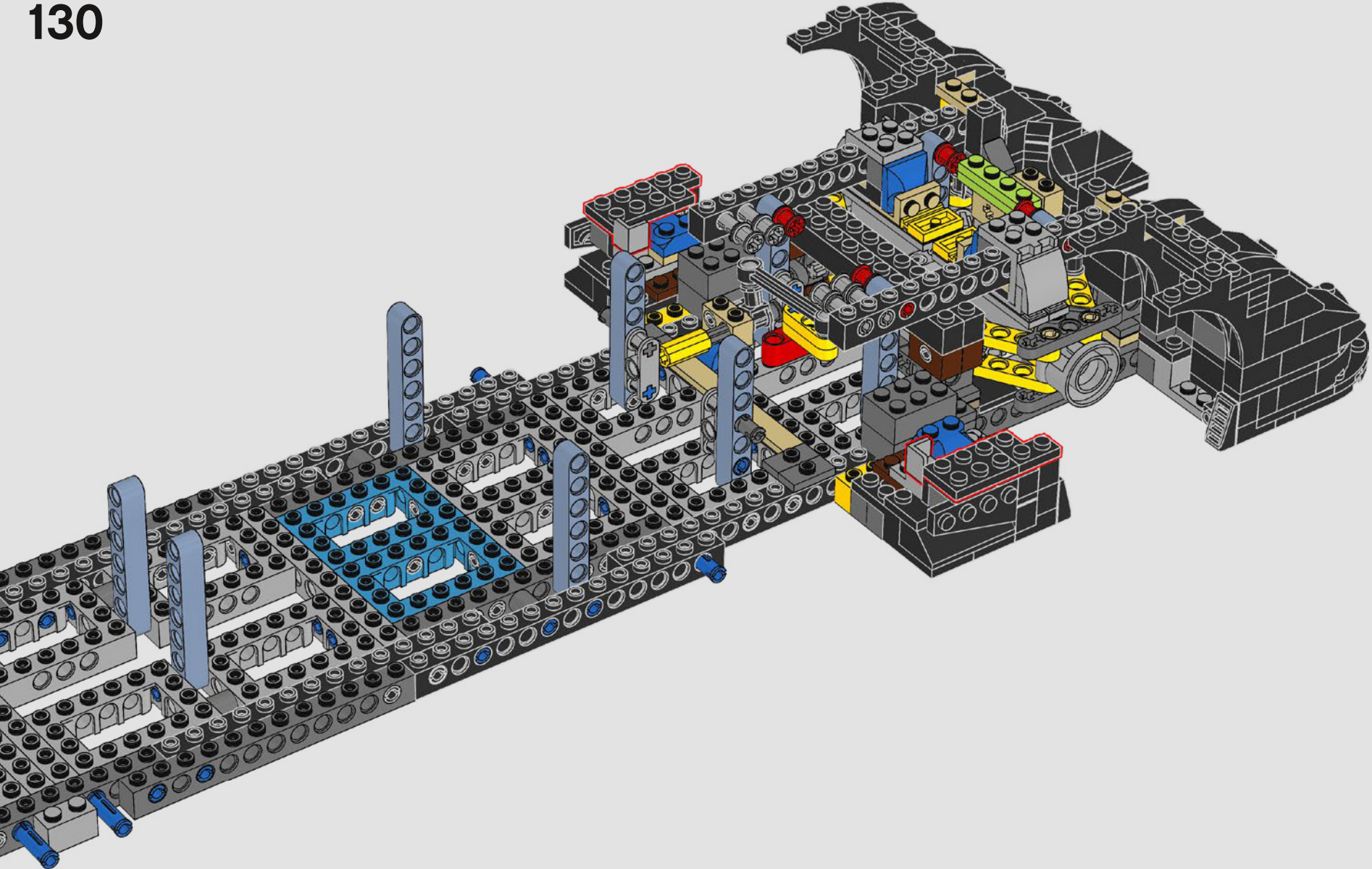

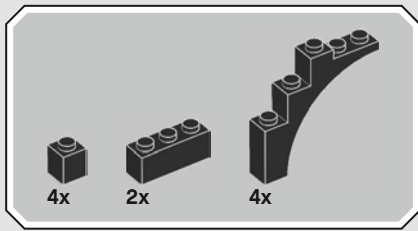

131

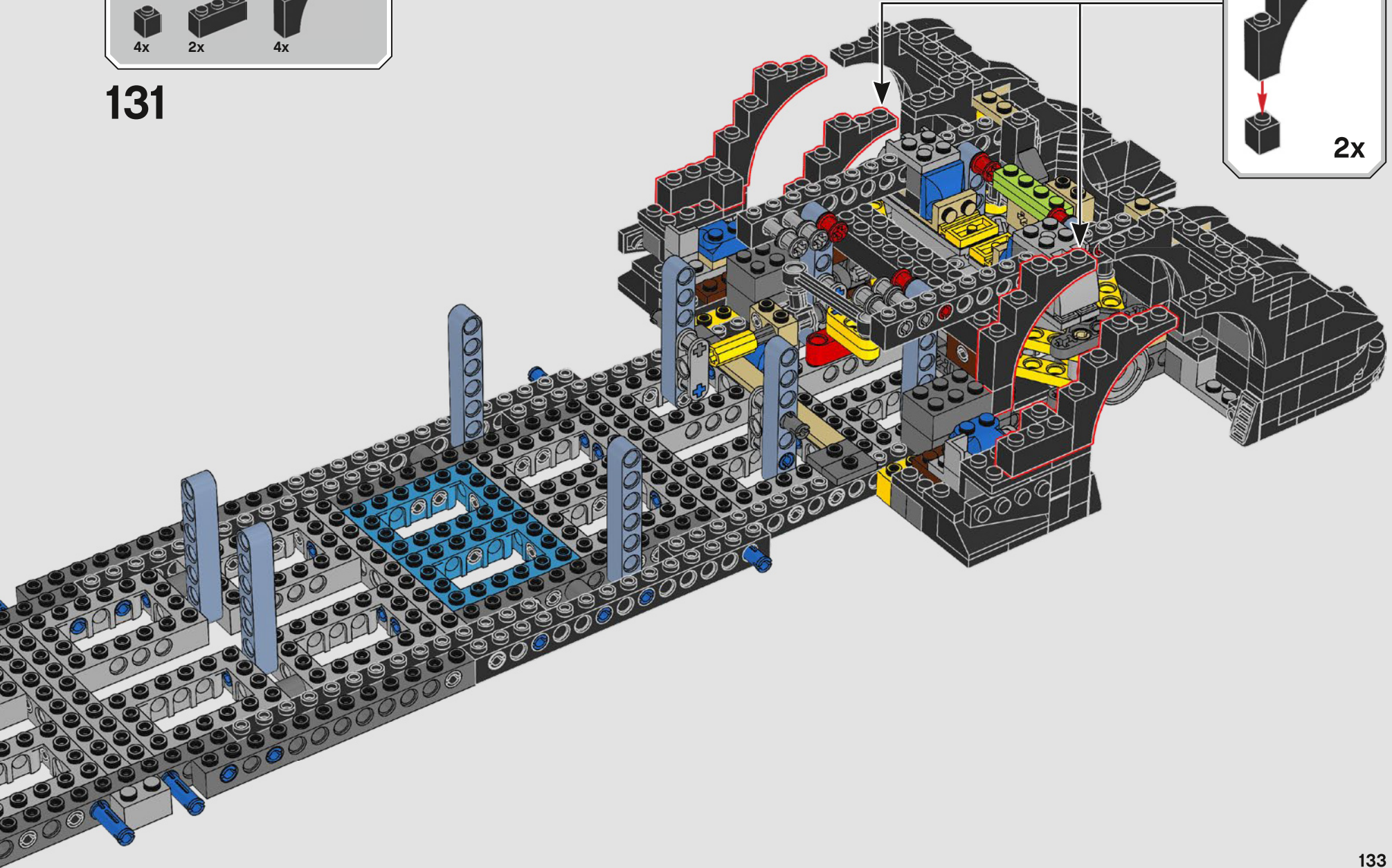
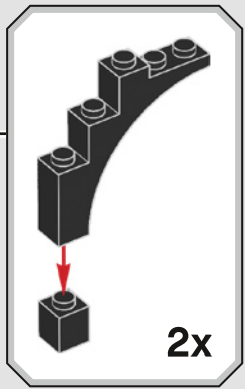

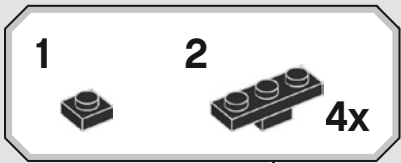
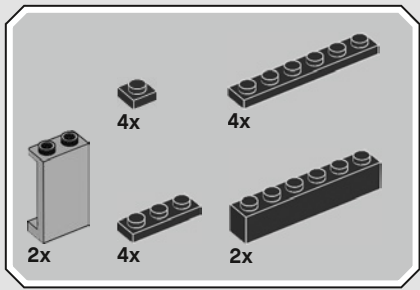

132

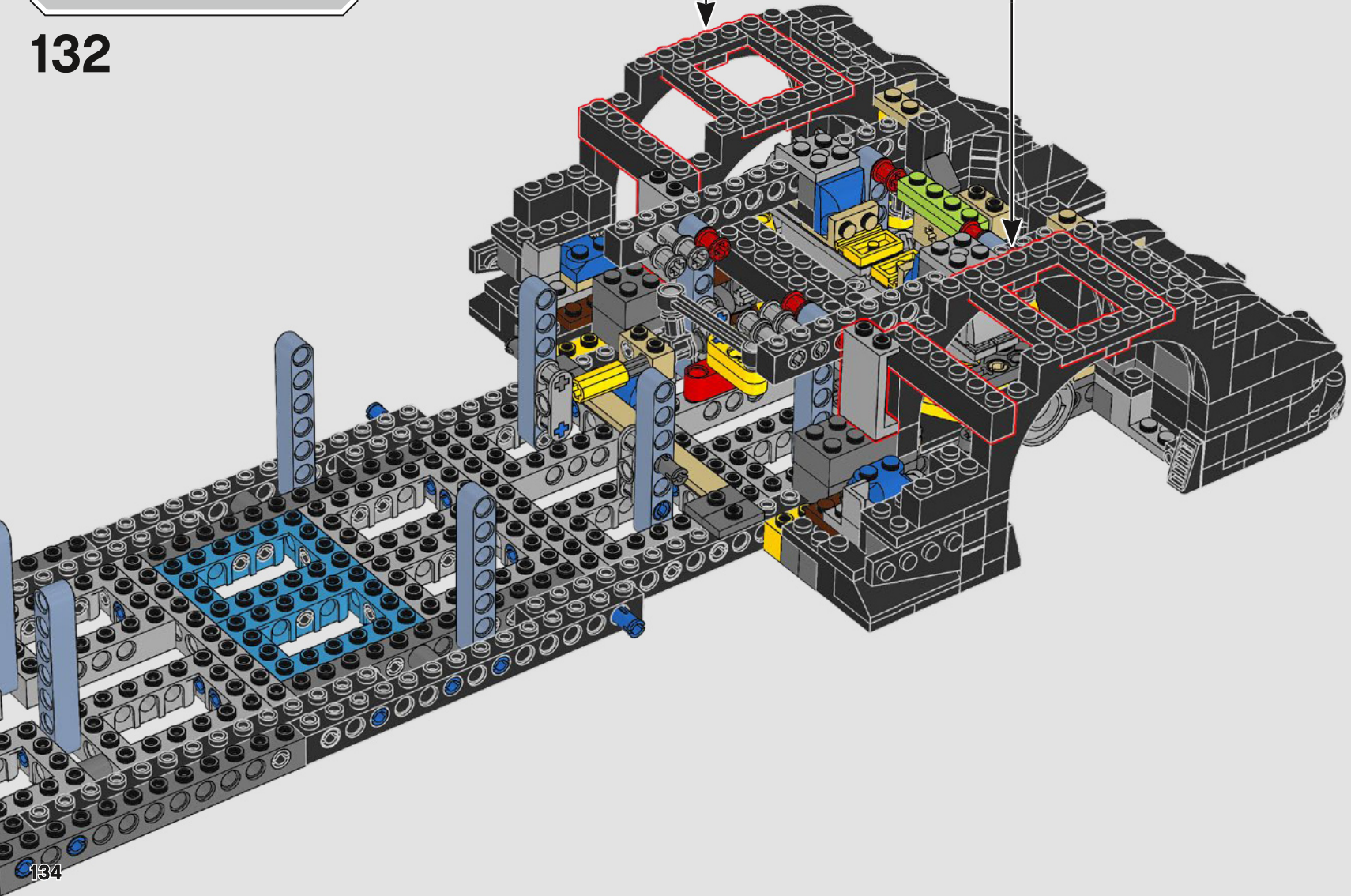

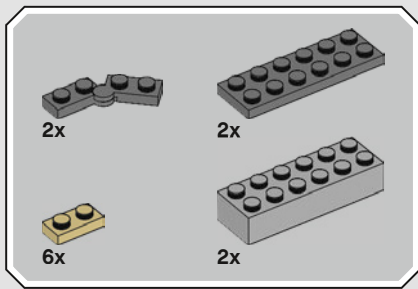

133

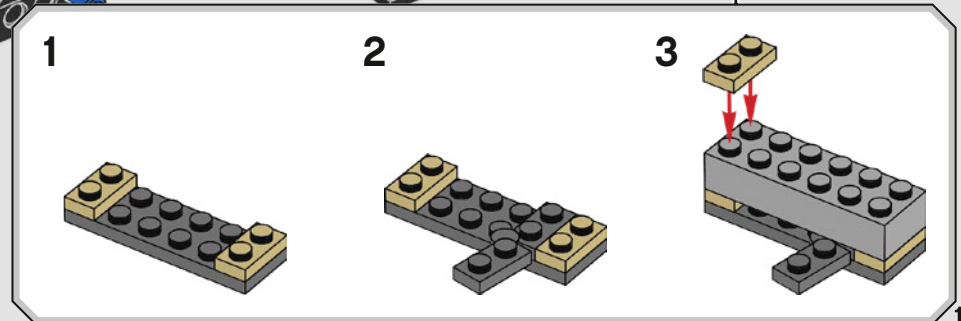
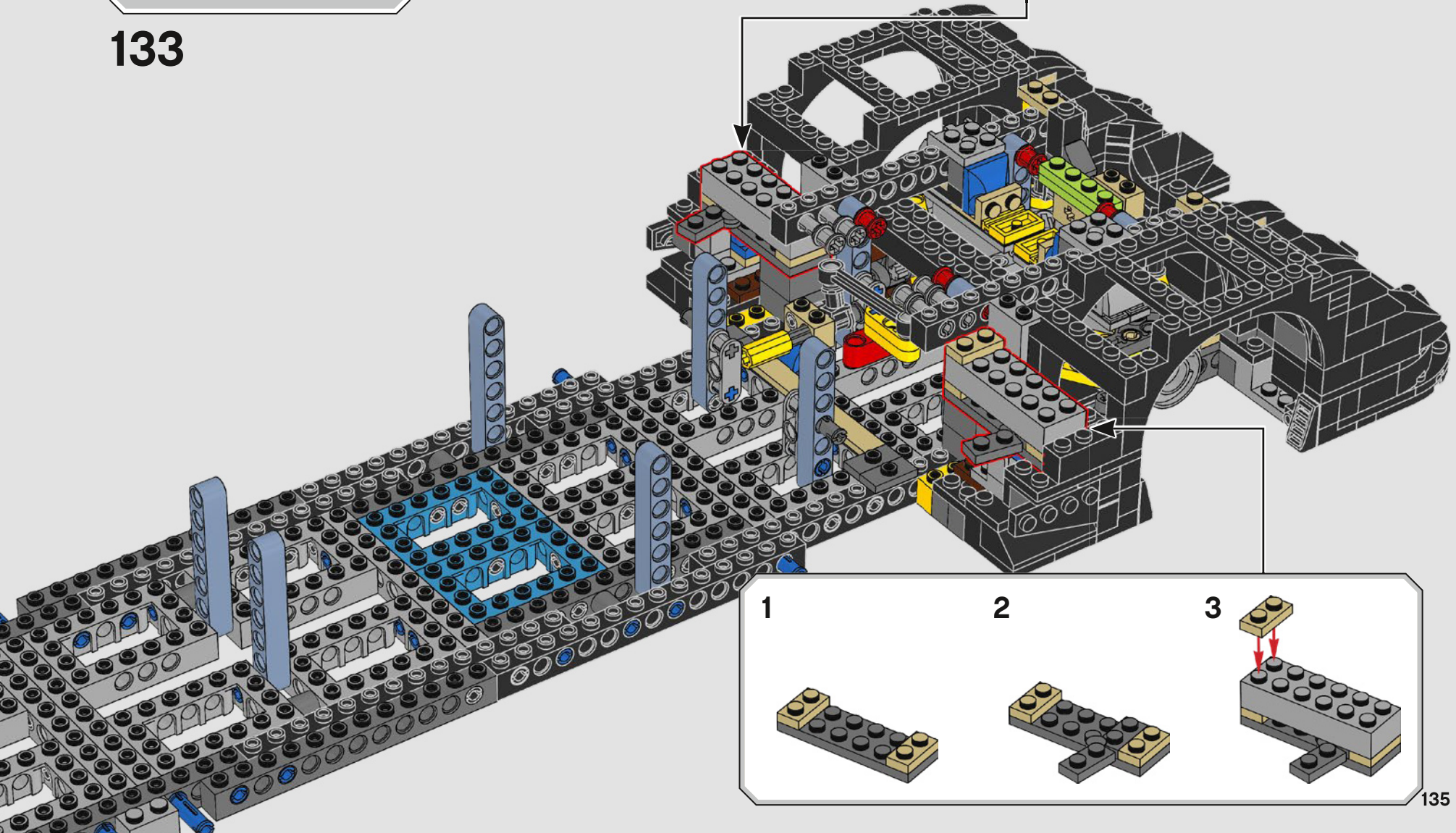
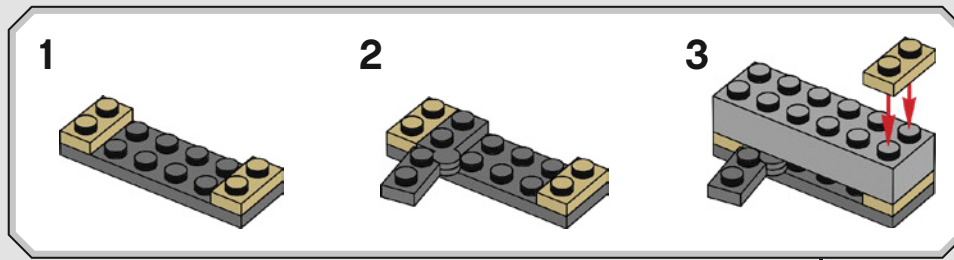

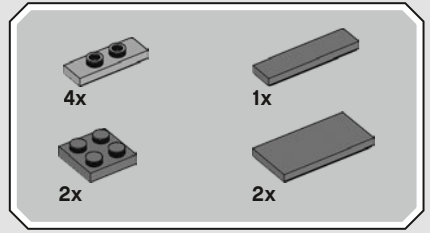
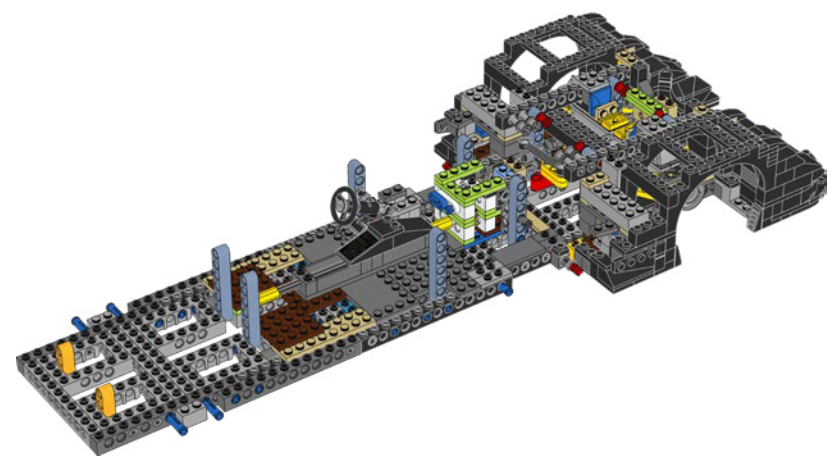
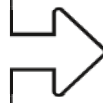
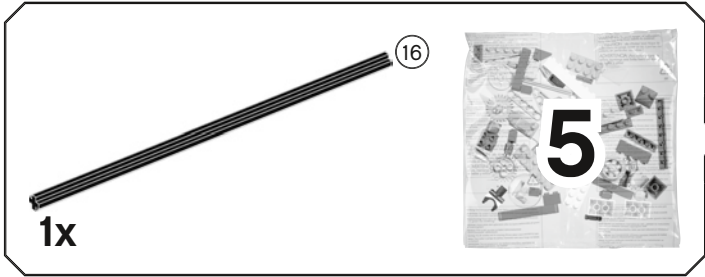

**134**

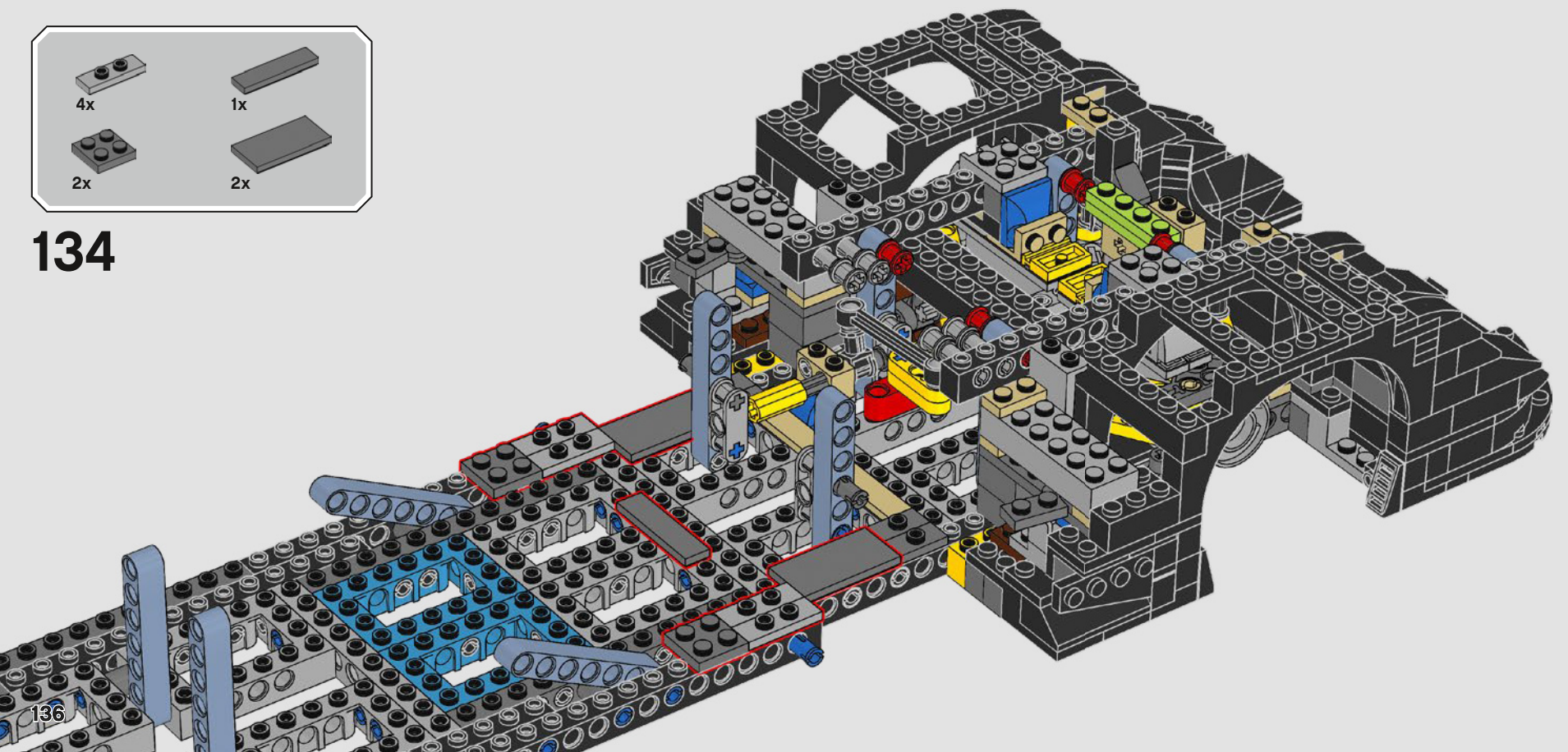



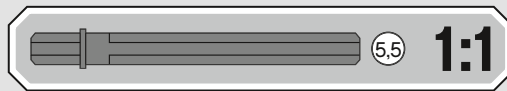
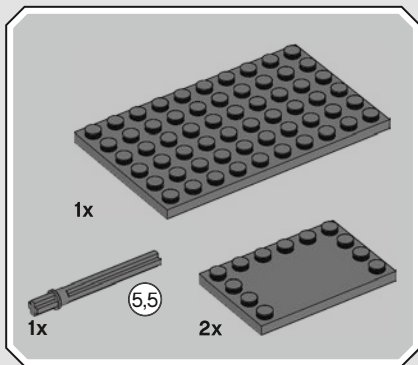

135

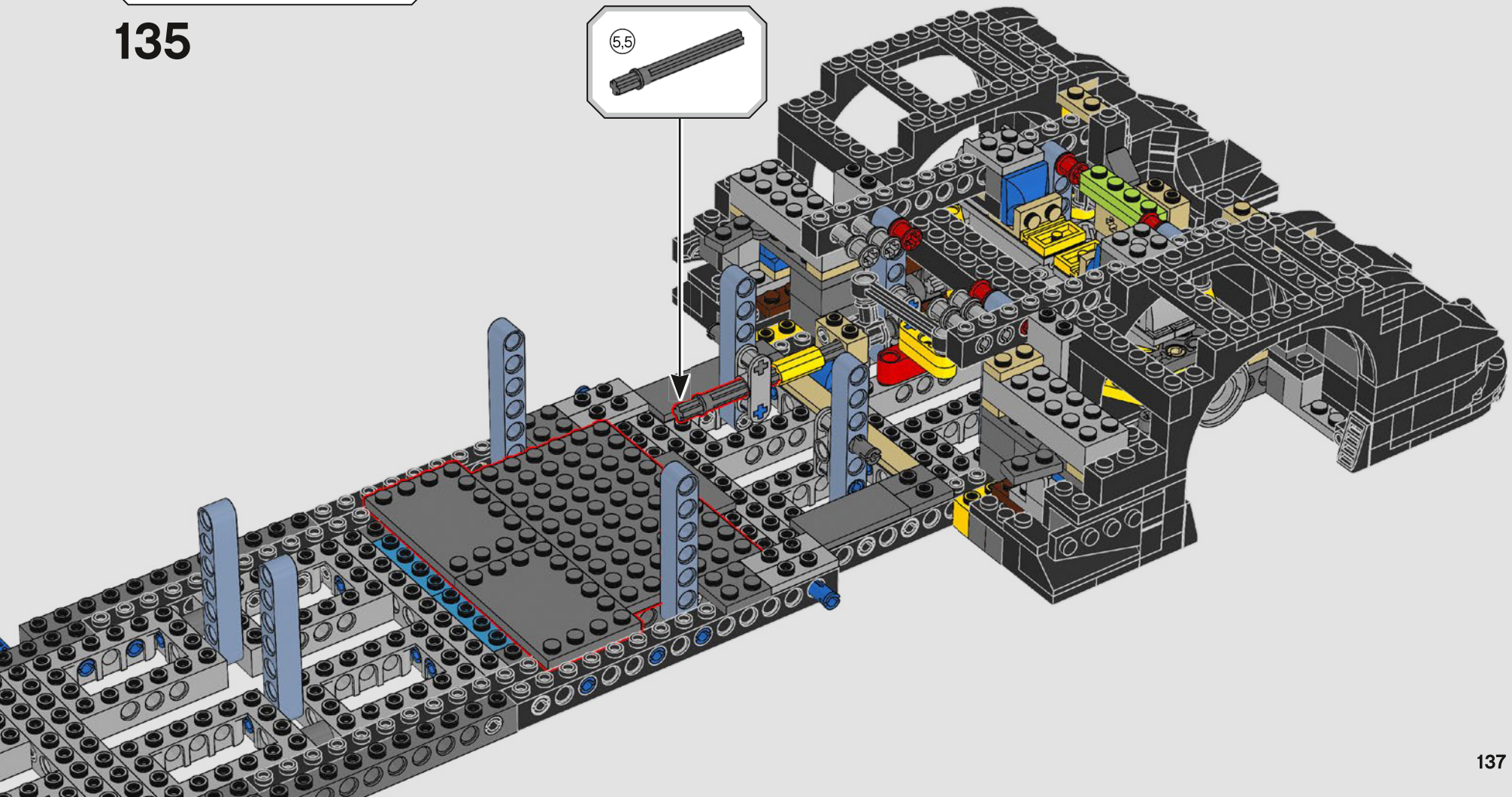
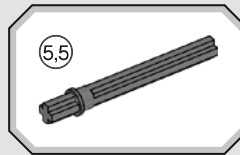

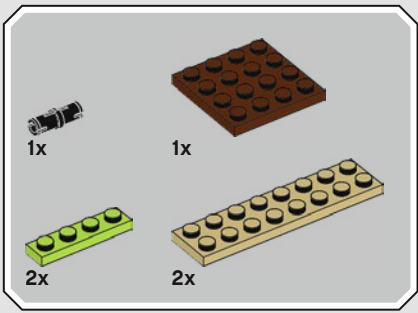

136

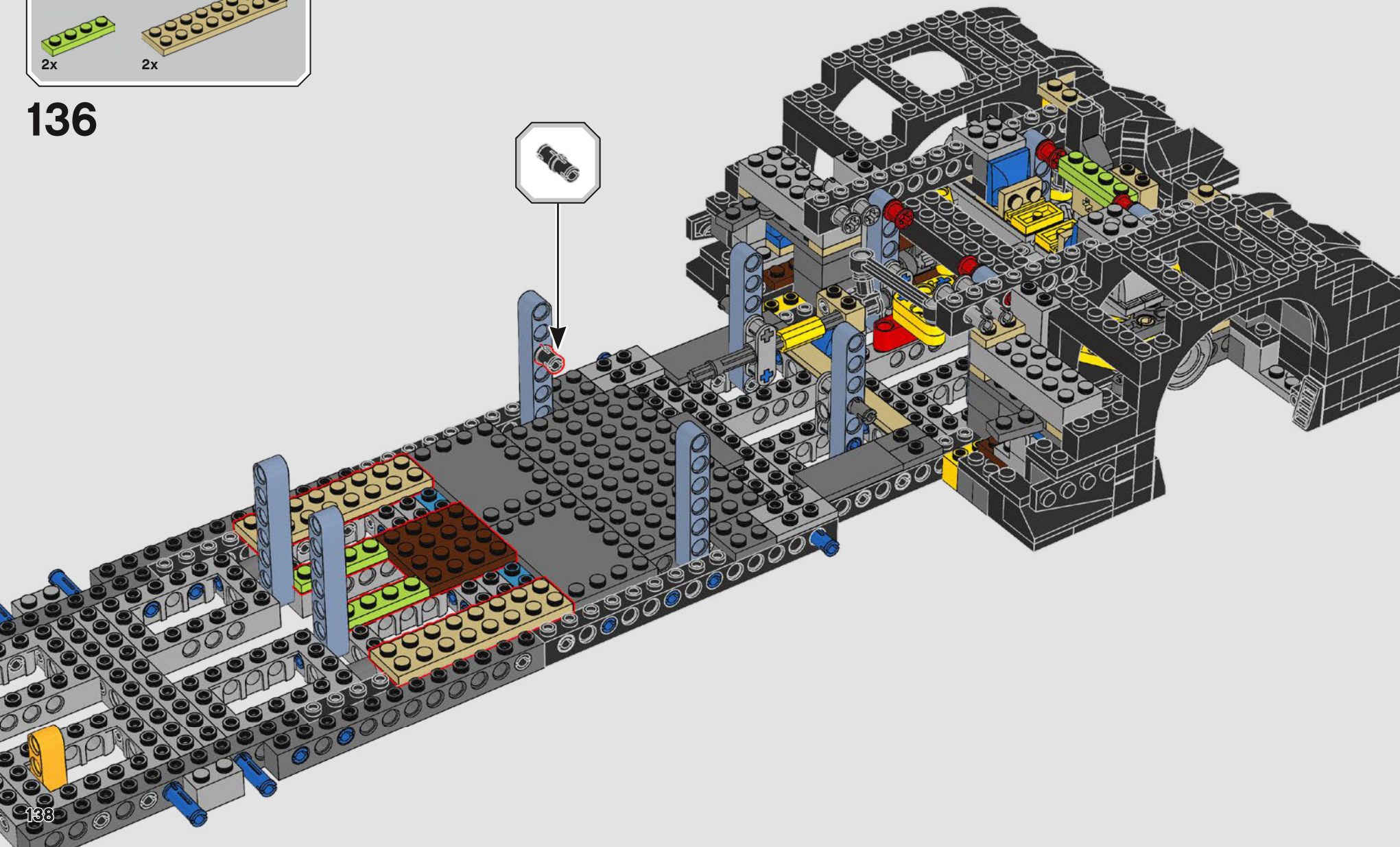

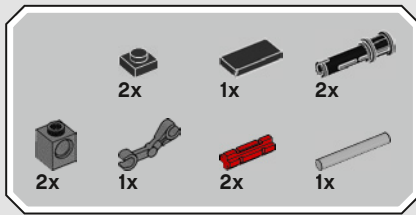

137

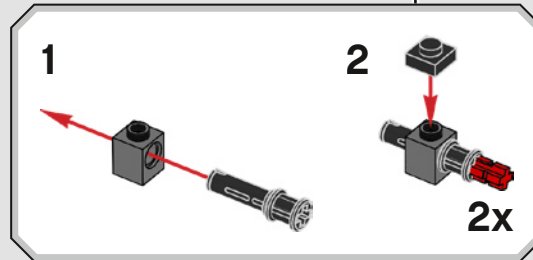
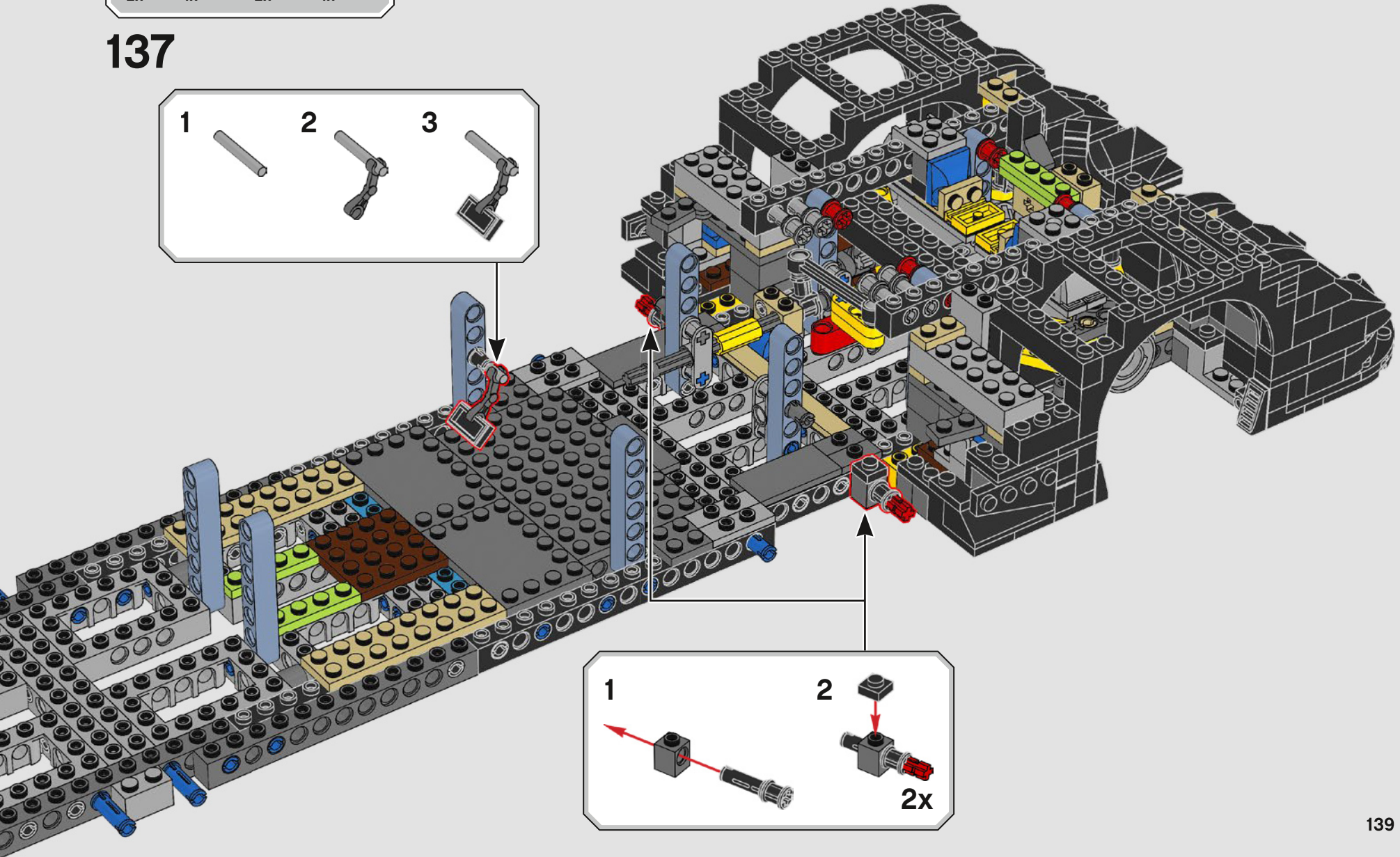
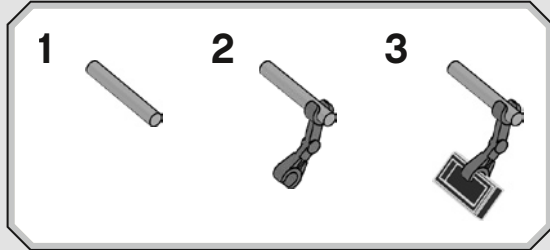

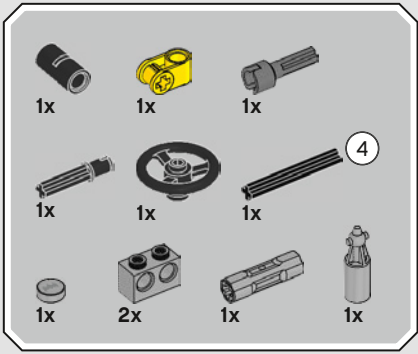

# 138

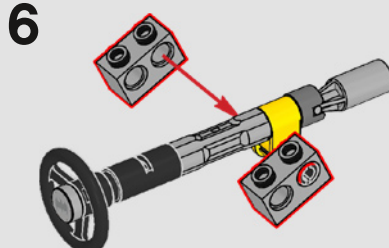
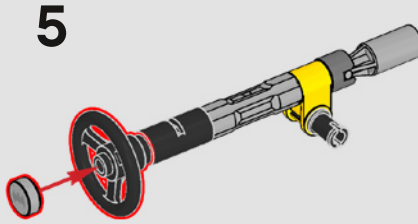
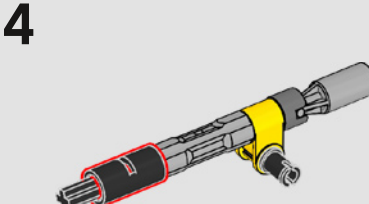
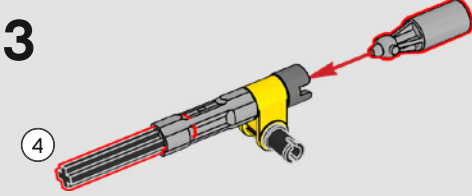
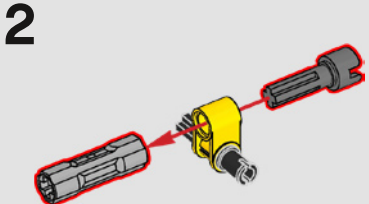
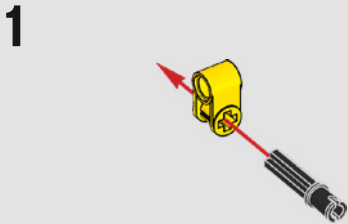

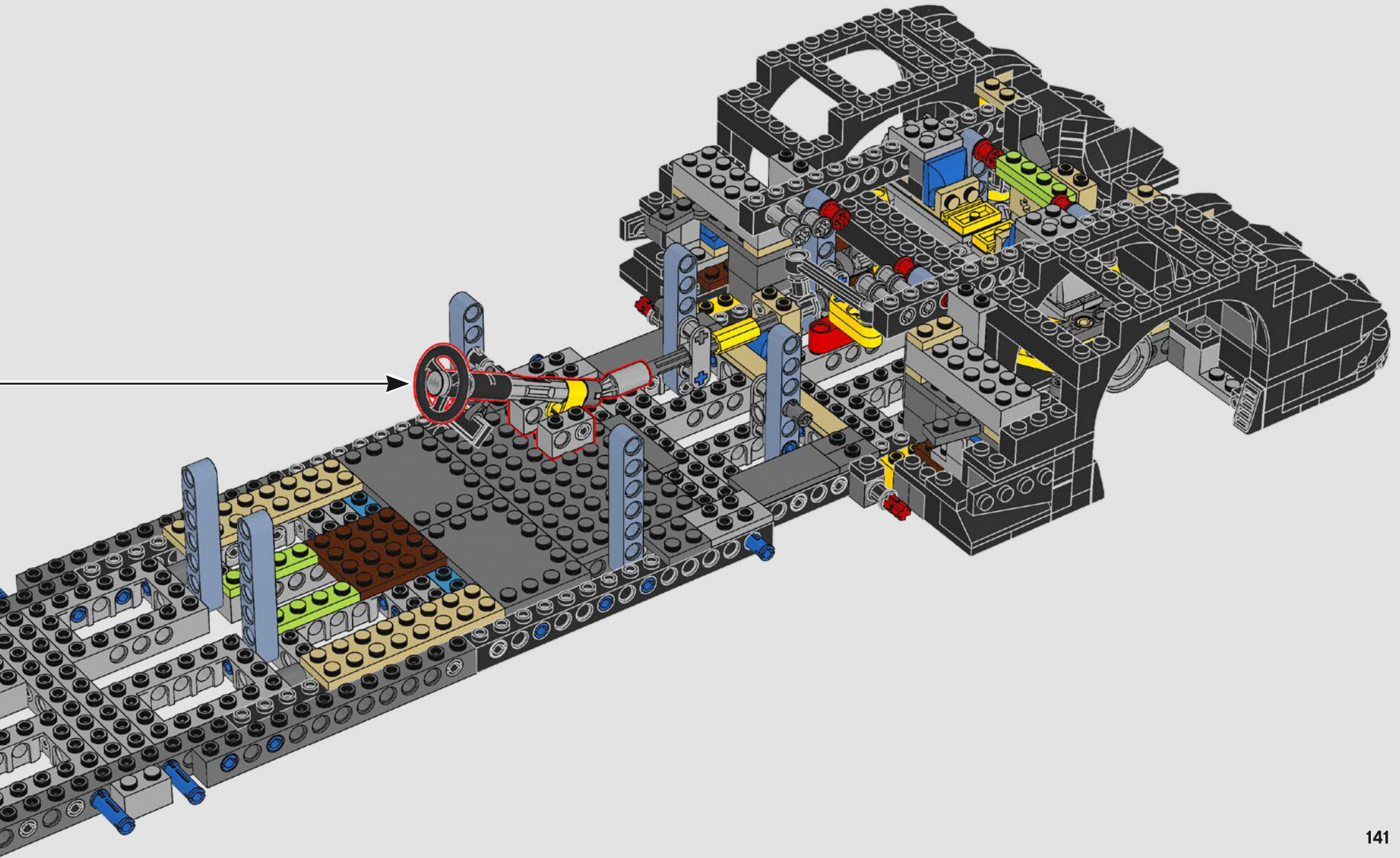

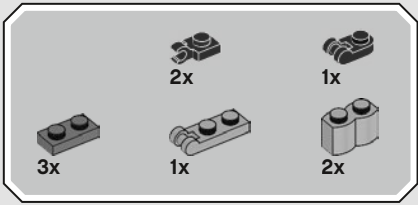

139

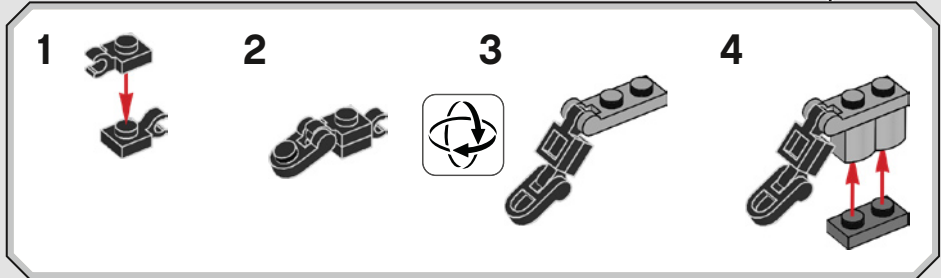
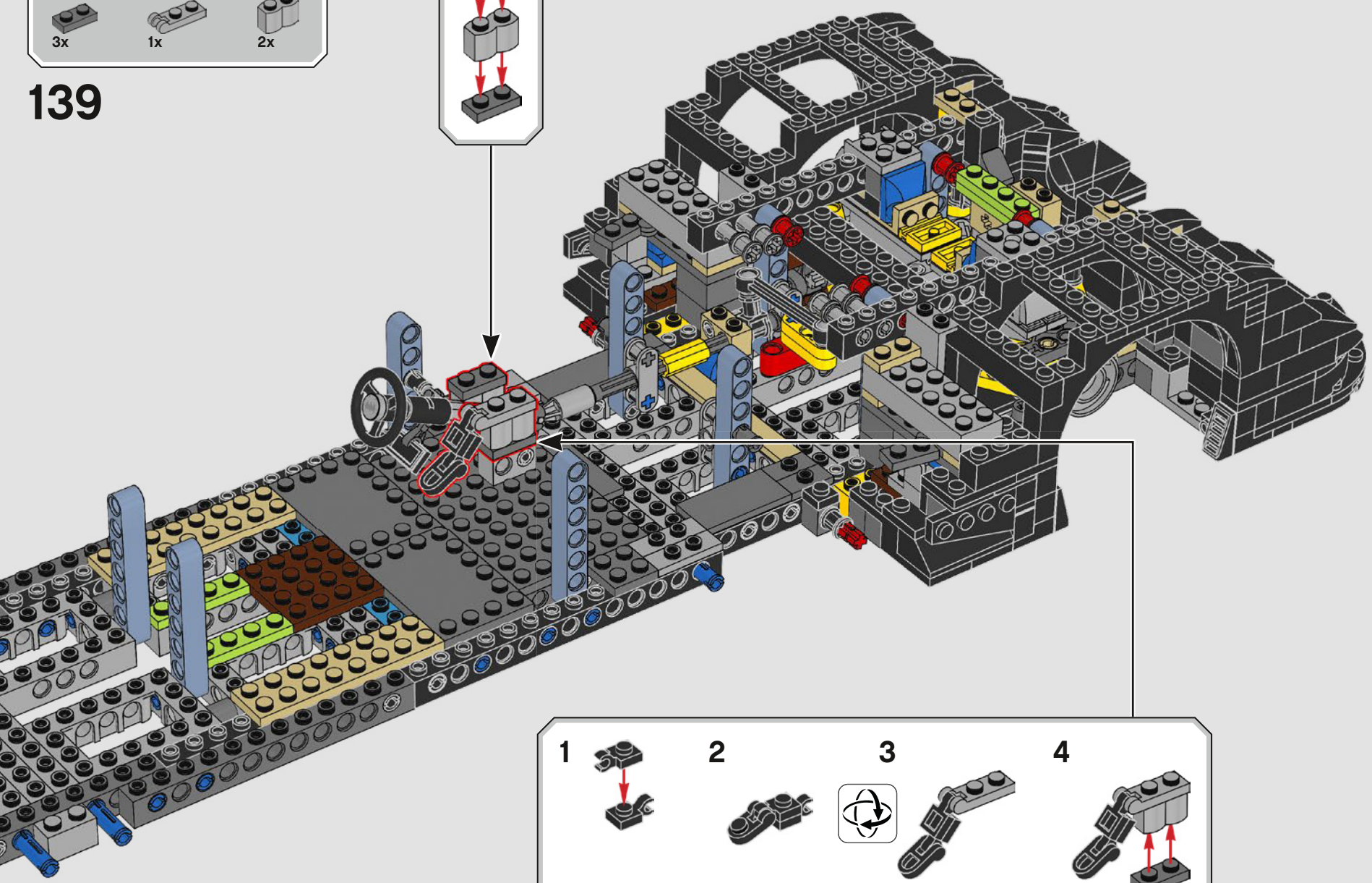
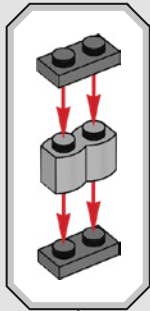

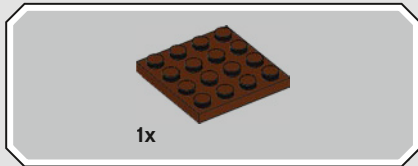
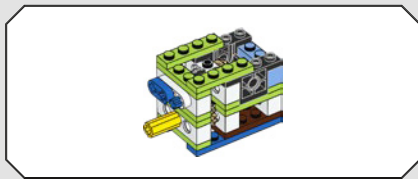

140

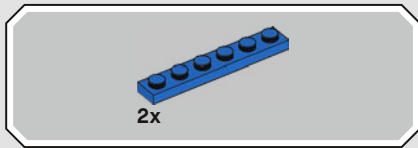
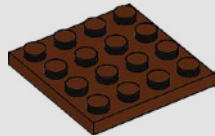

141

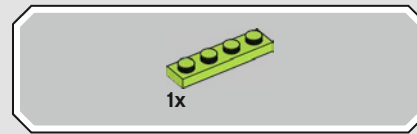
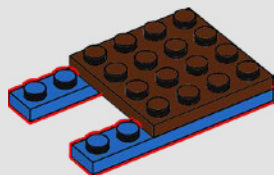

142

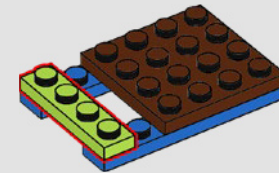

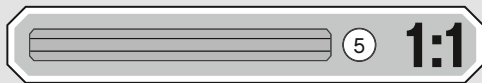
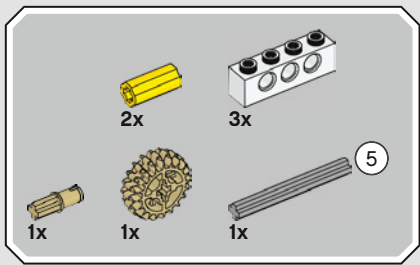

143

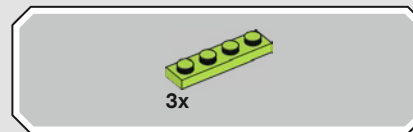
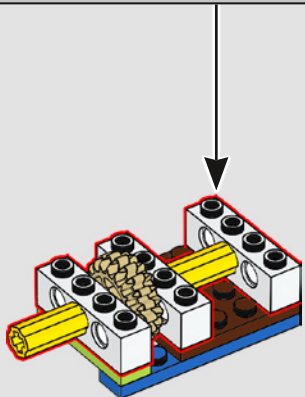
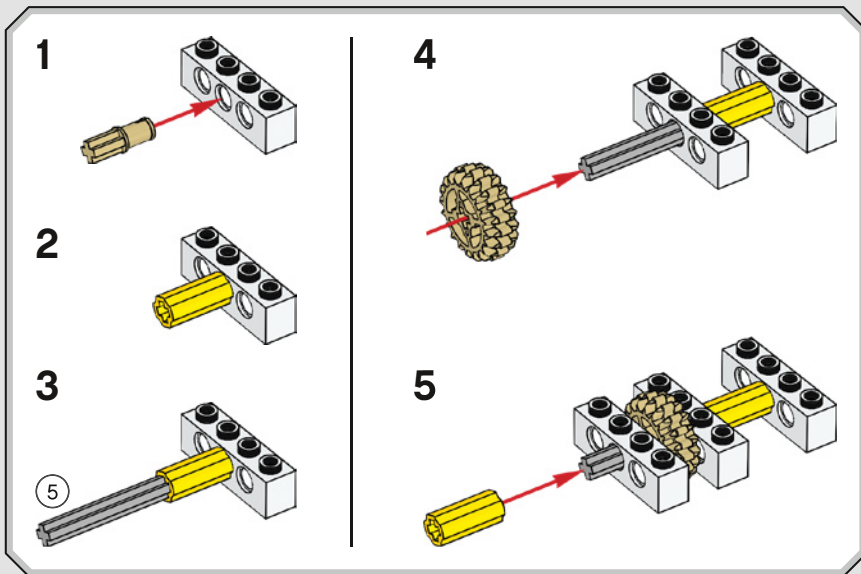

144

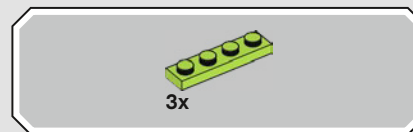
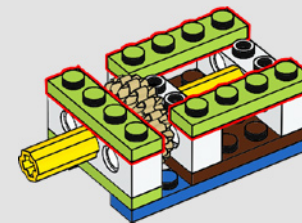

145

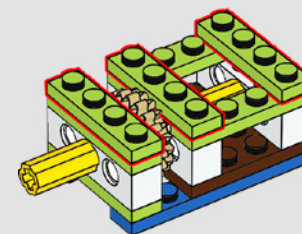



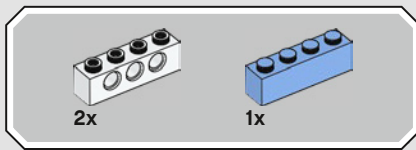

146

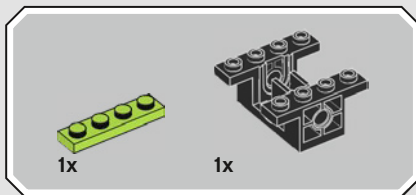
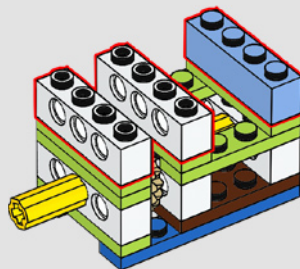

147

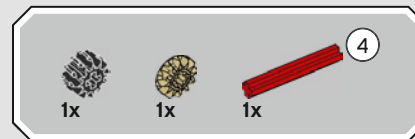
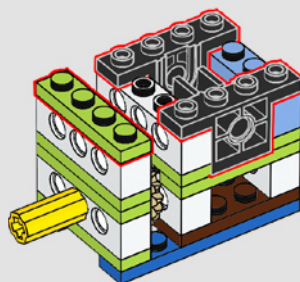

148

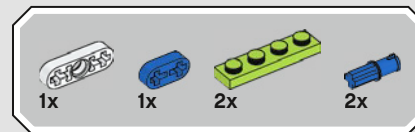
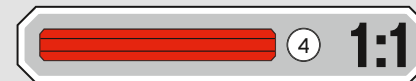
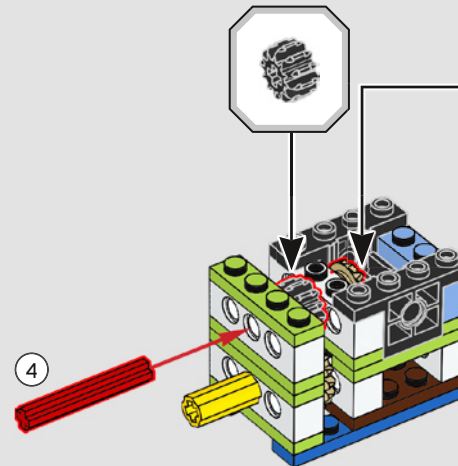

149

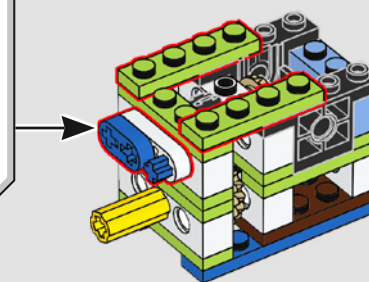
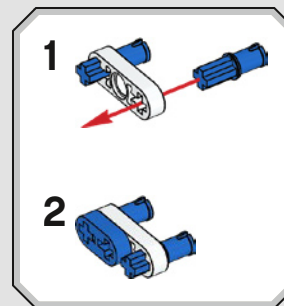

150

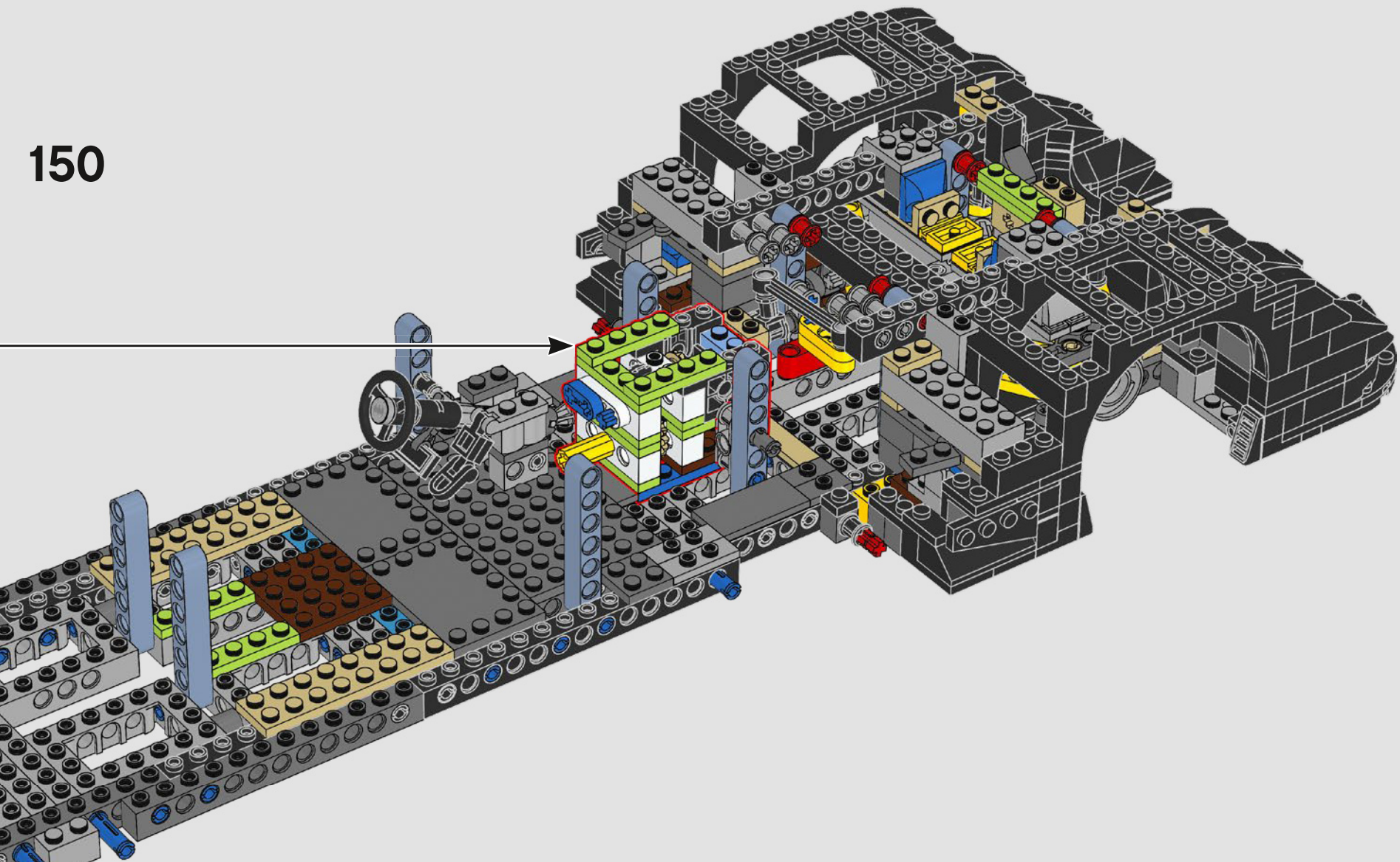

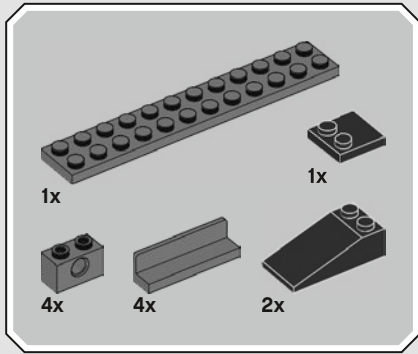

151

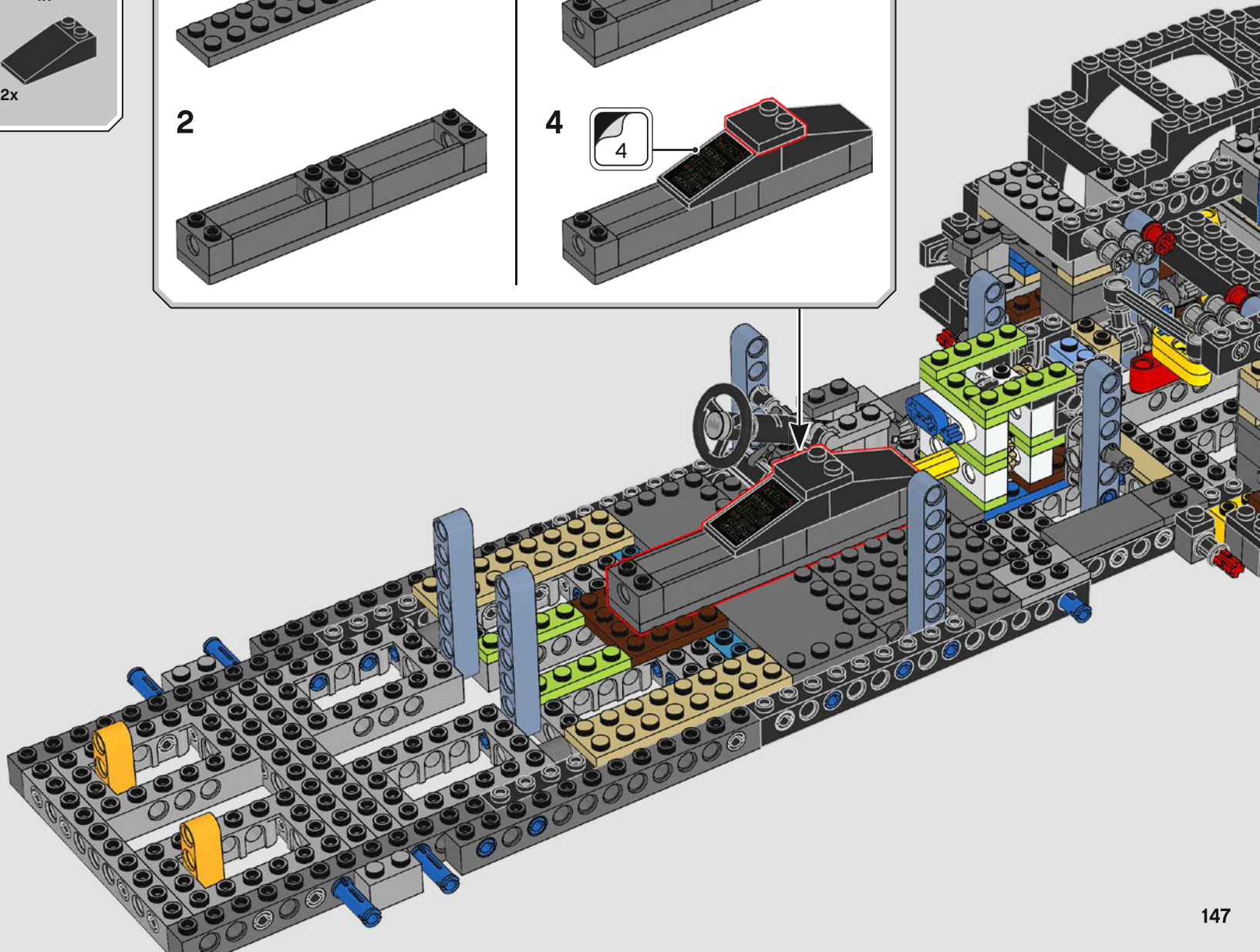
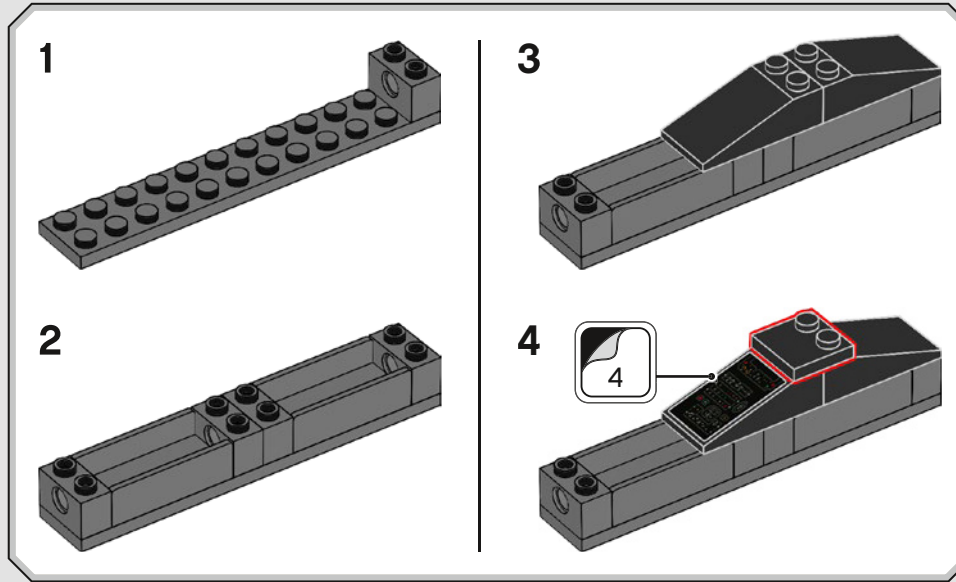

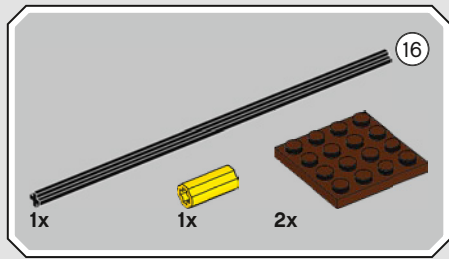

152

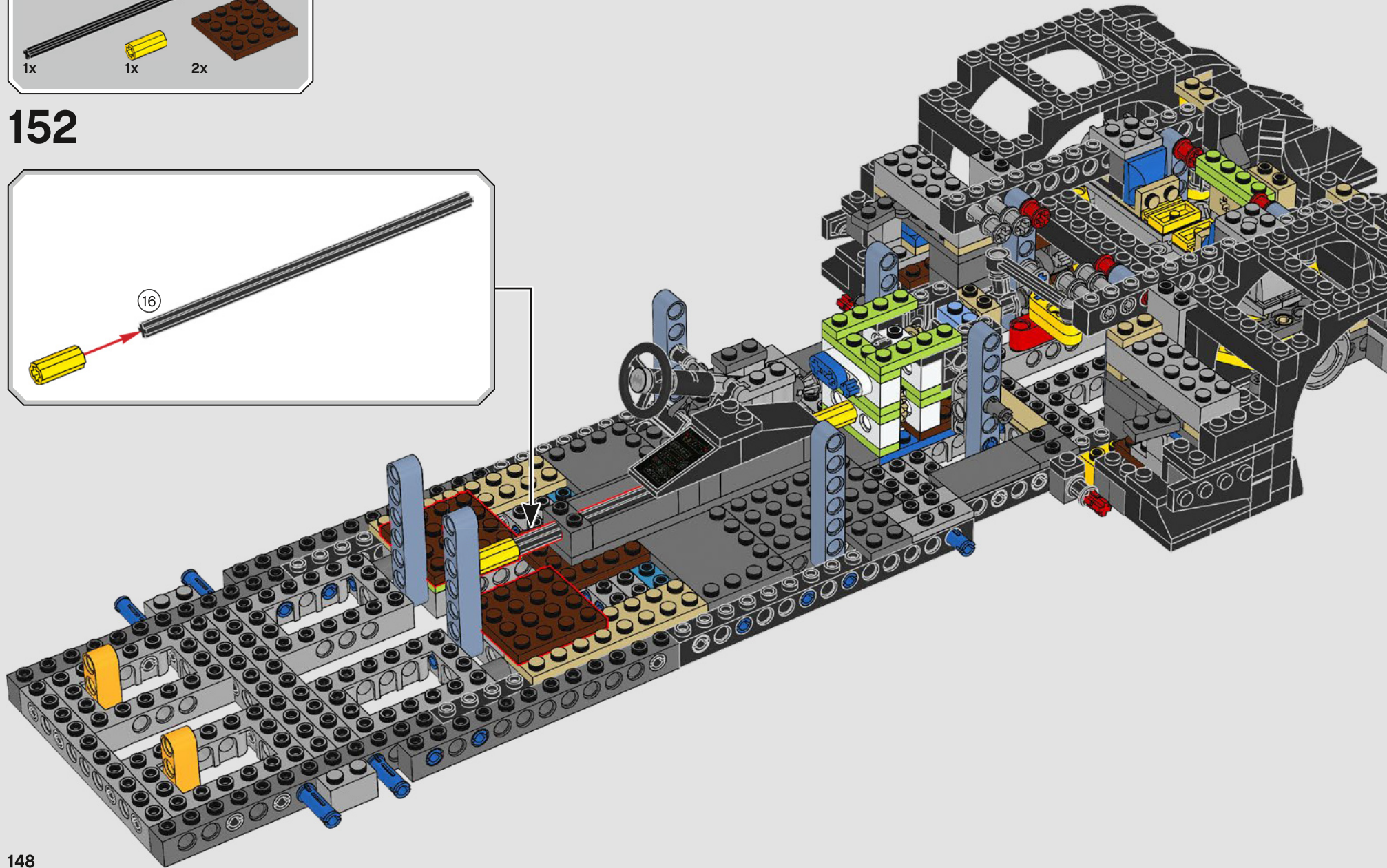
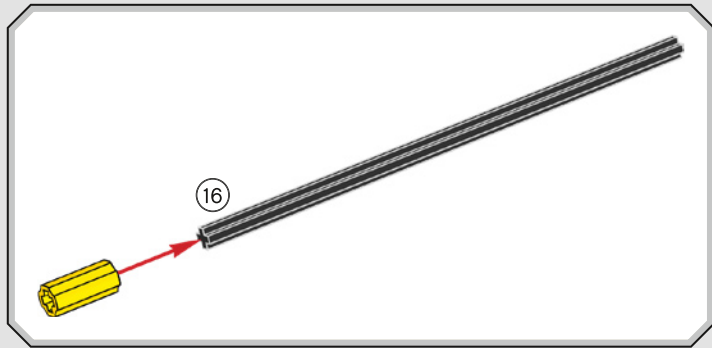

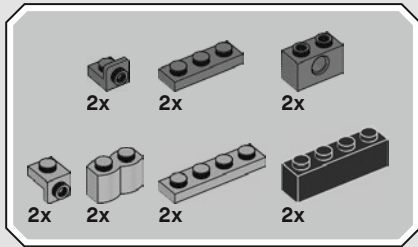
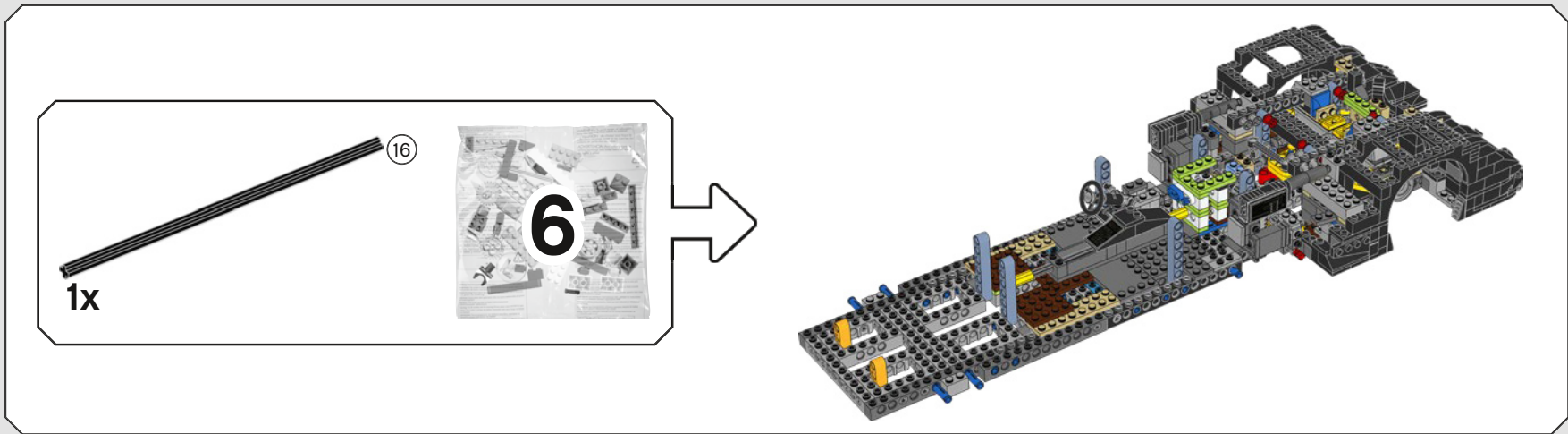

# 153

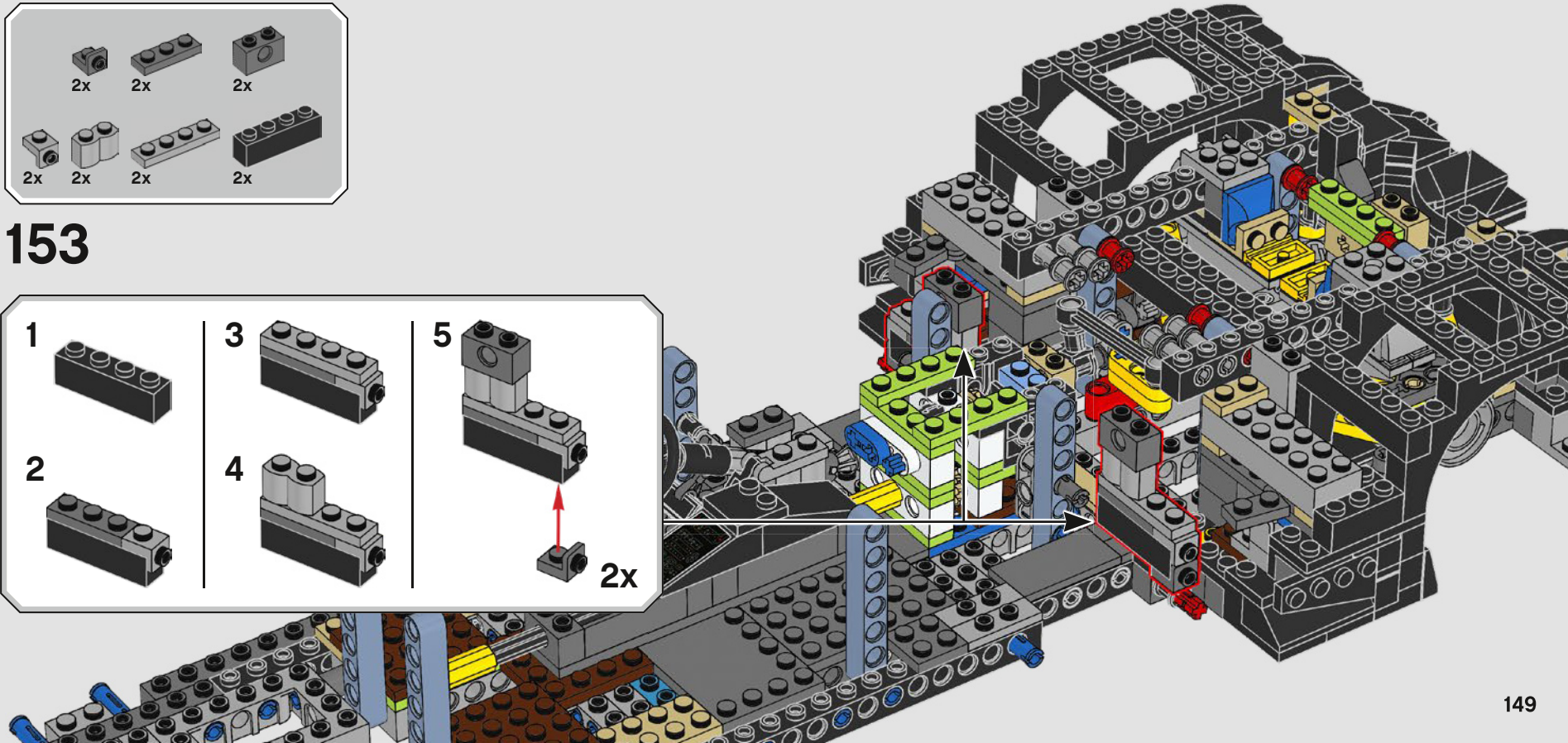
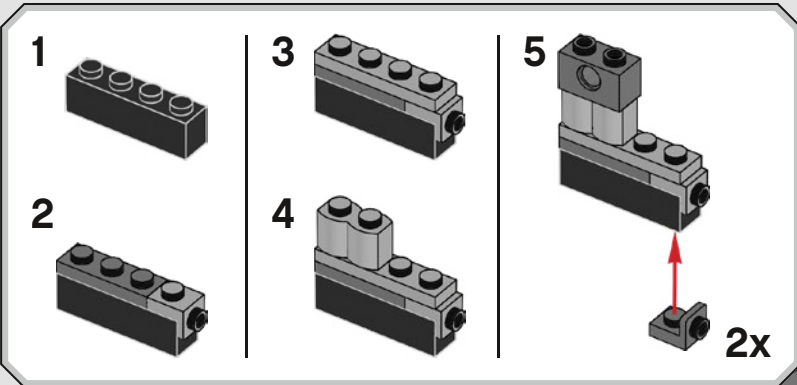

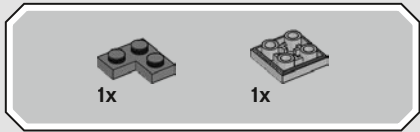

154

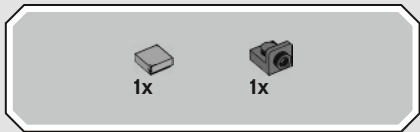
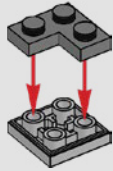

155

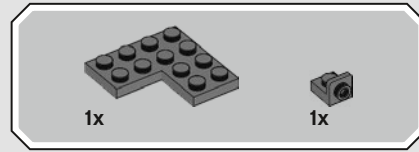
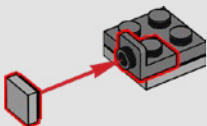

156

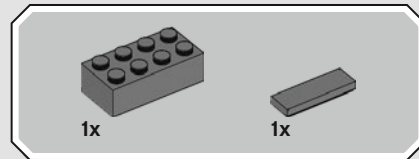
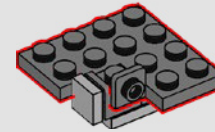

157

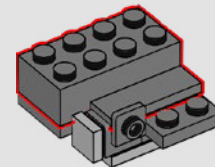

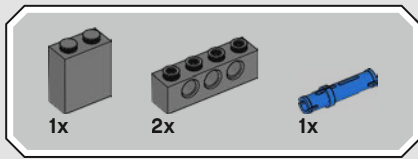

158

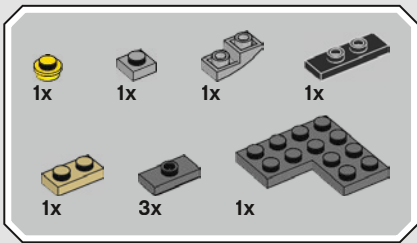
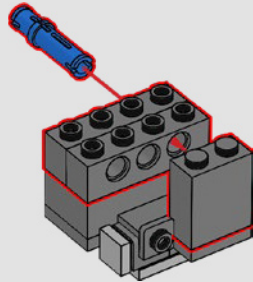

159

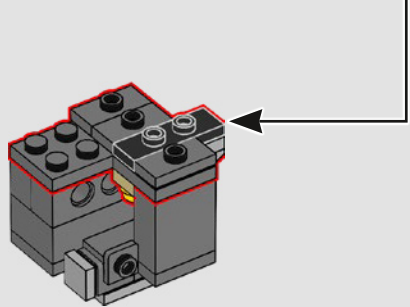
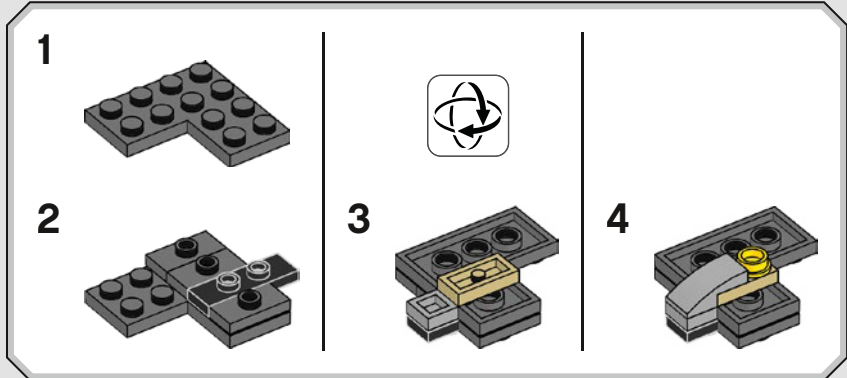

160

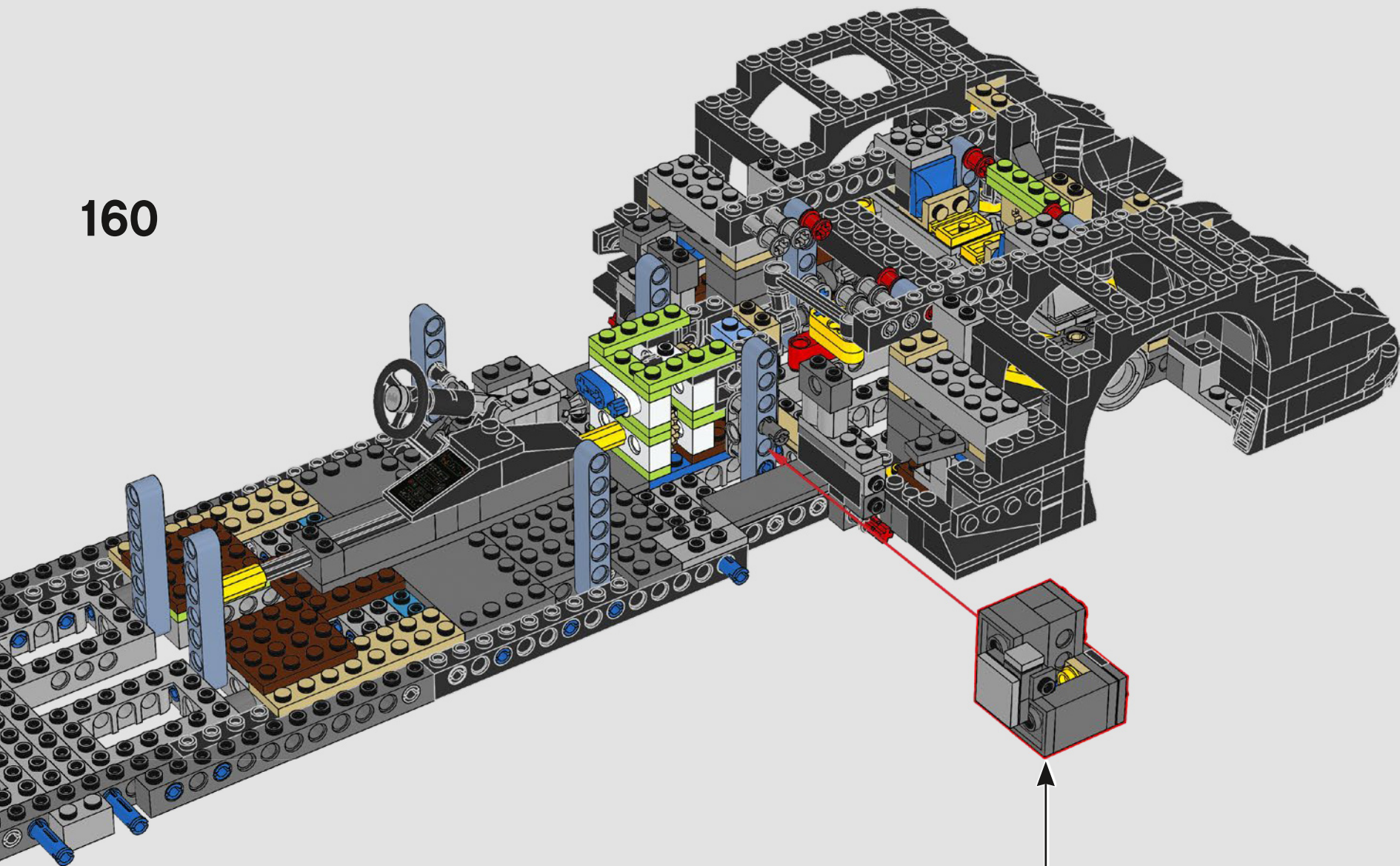



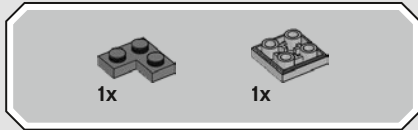
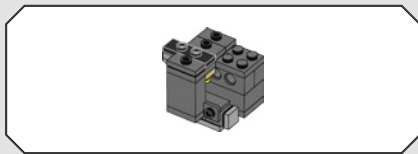

161

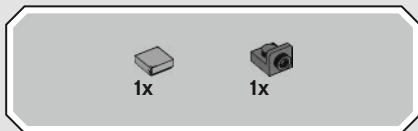
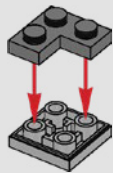

162

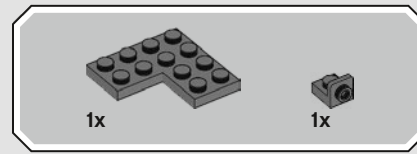
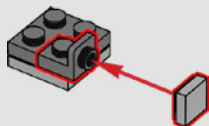

163

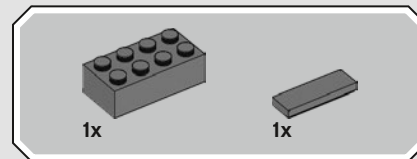
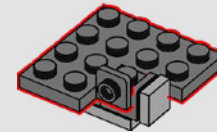

164

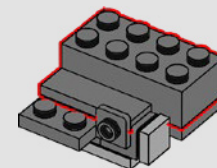

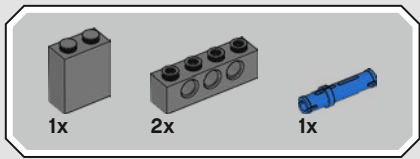

165

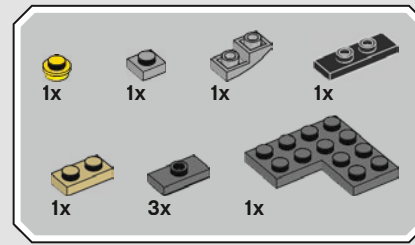
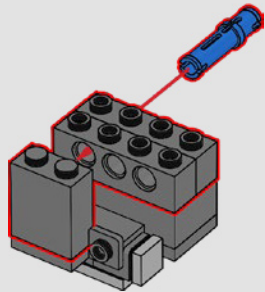

166

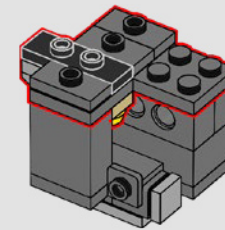
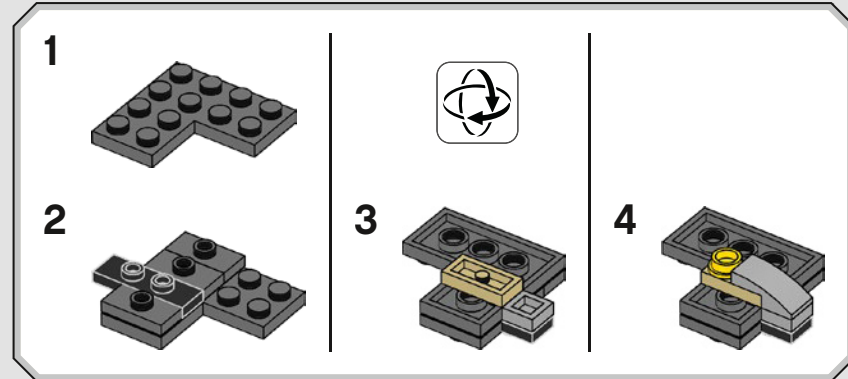

167

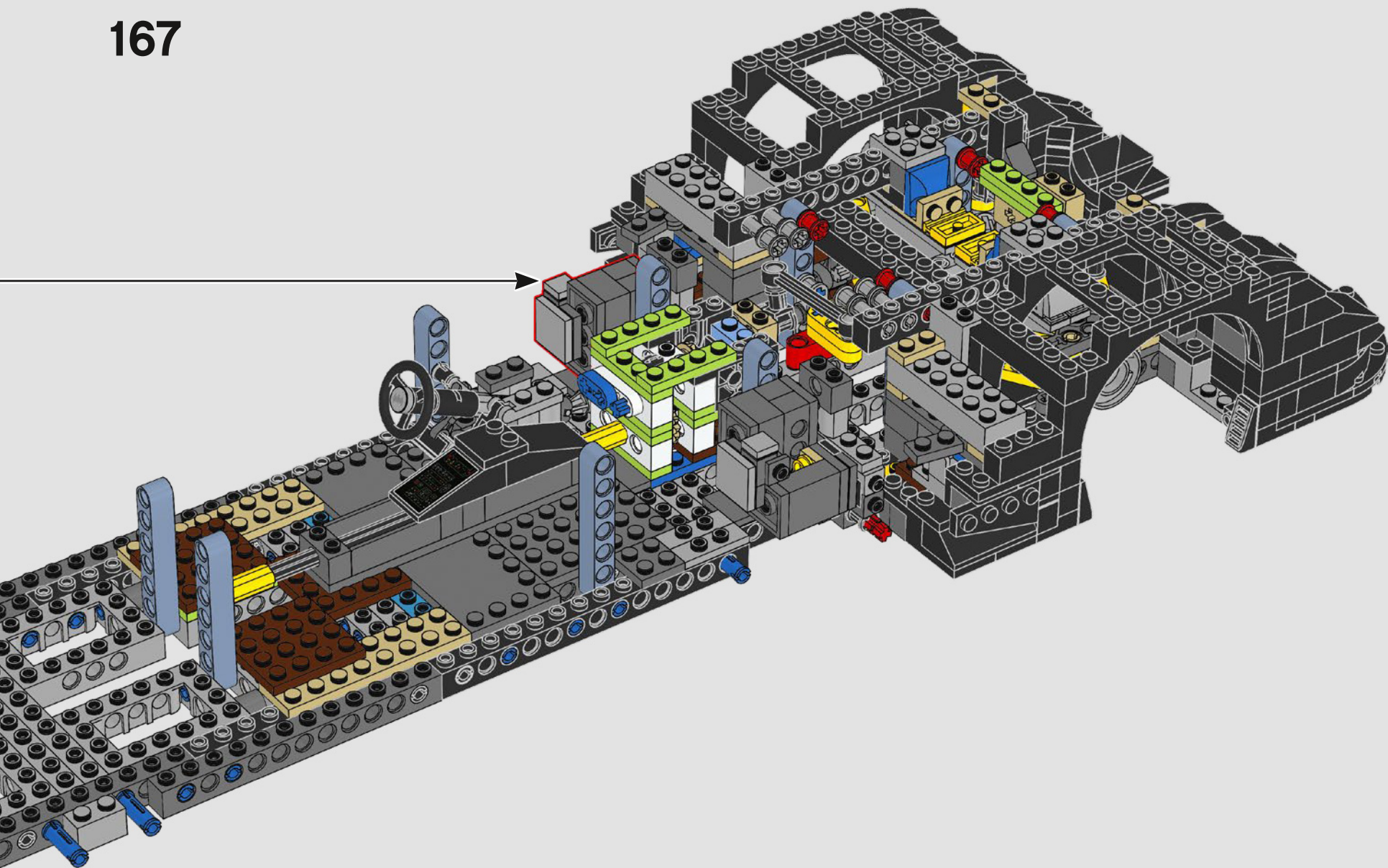

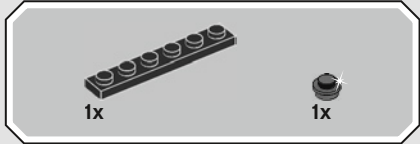

168

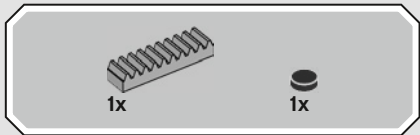
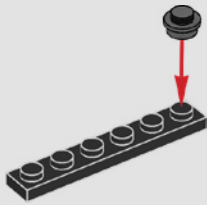

169

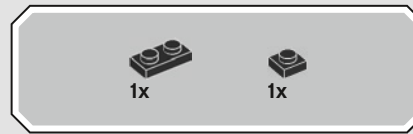
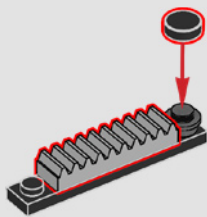

170

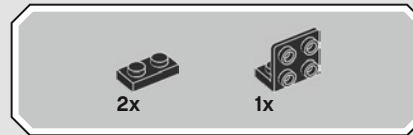
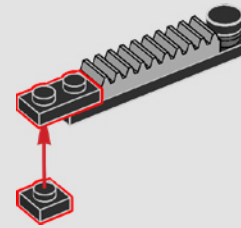

171

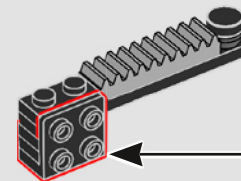
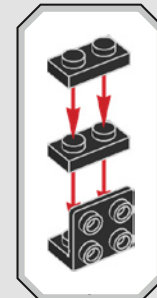



172

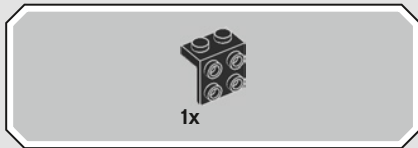
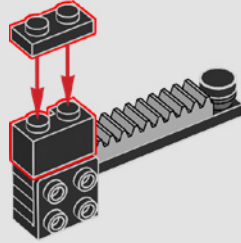

173

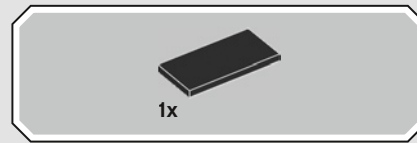
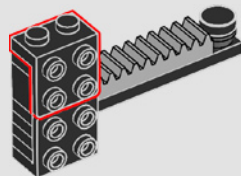

174

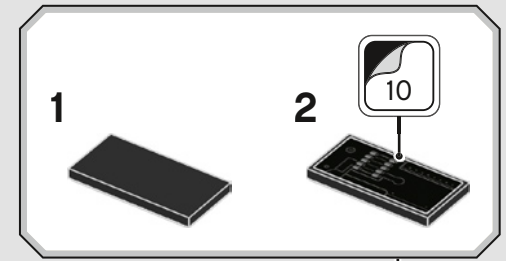
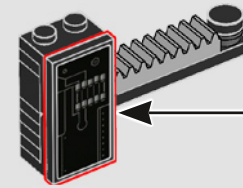

175

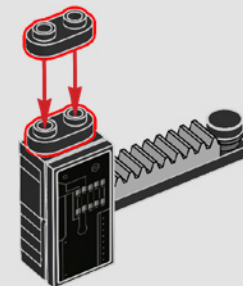

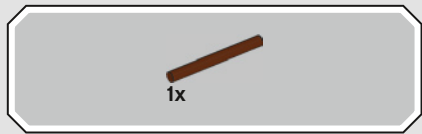

176

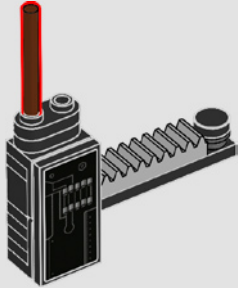

177

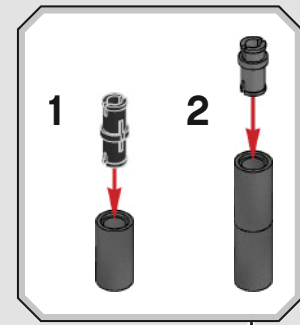
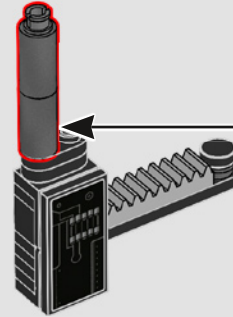

178

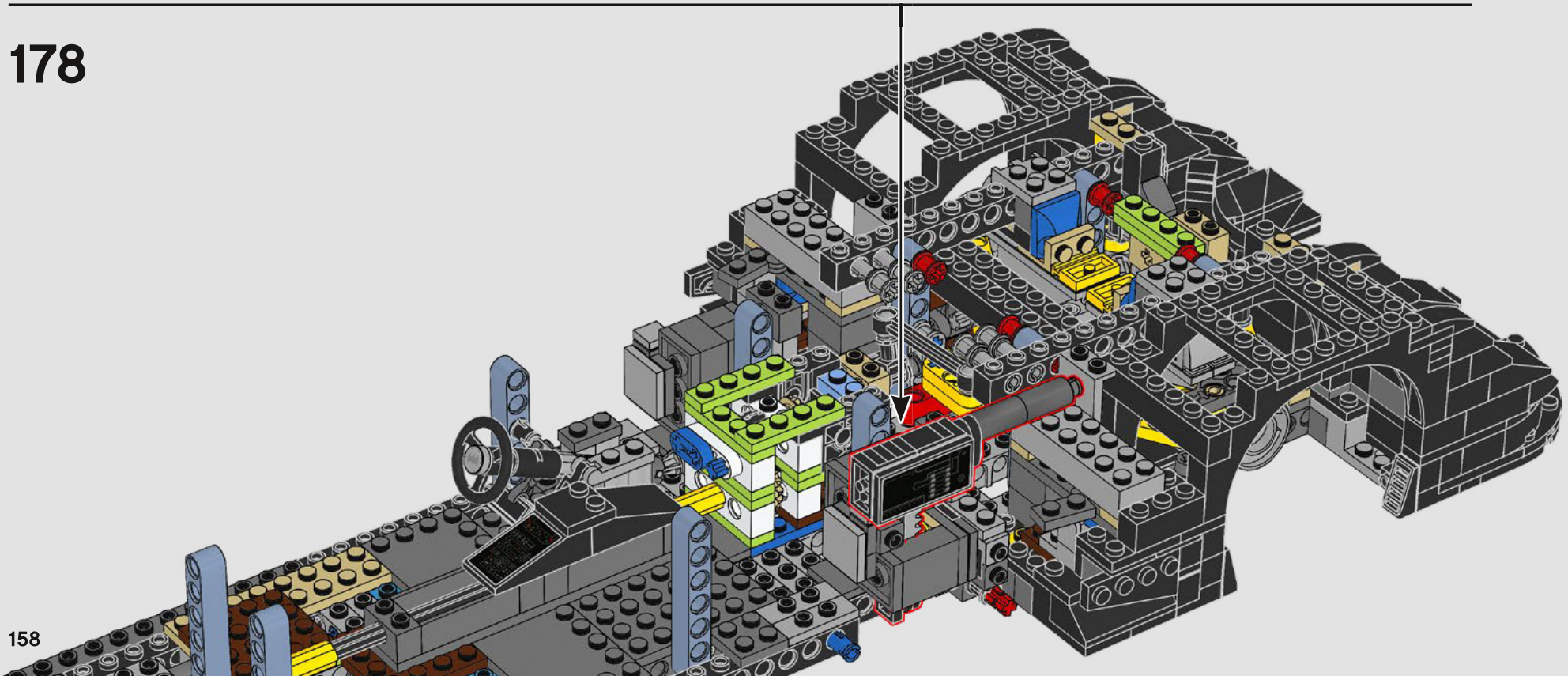

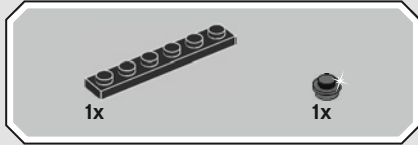
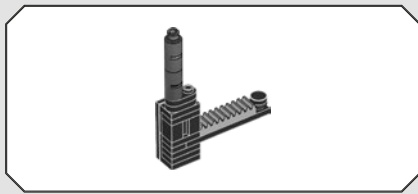

179

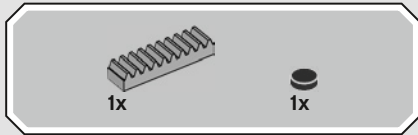
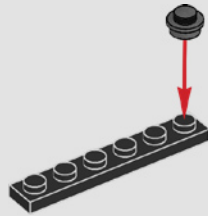

180

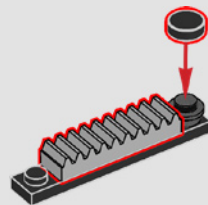

181

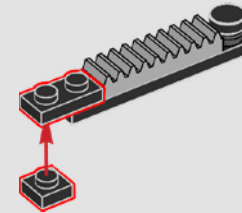

182

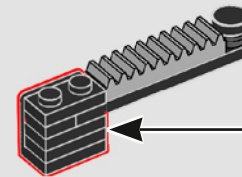
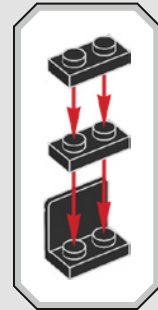



183

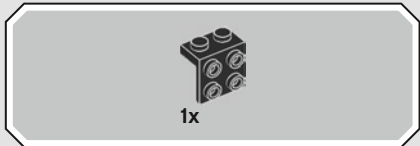
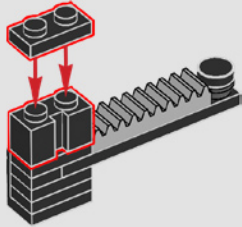

184

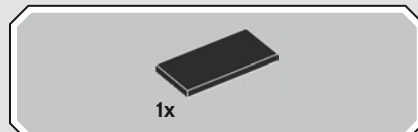
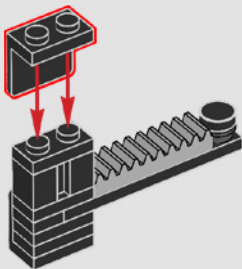

185

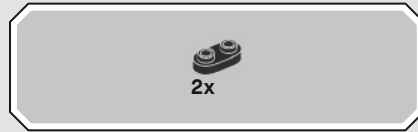
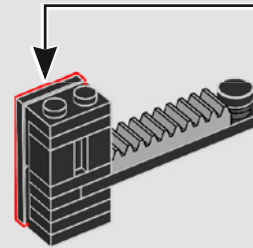
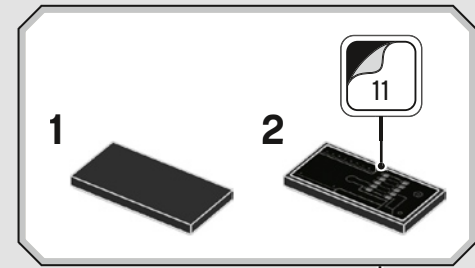

186

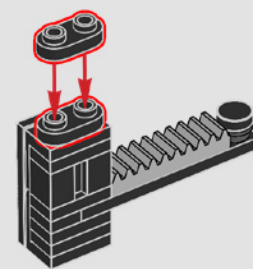



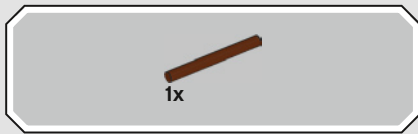

187

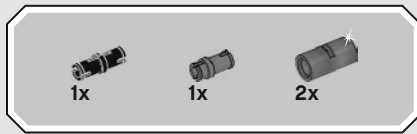
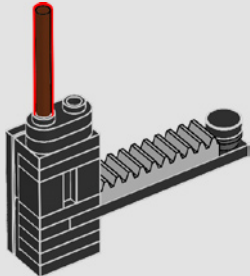

188

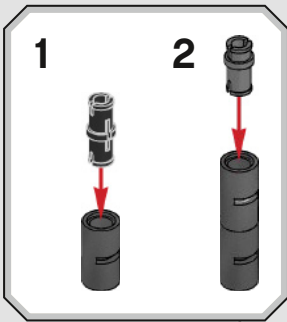
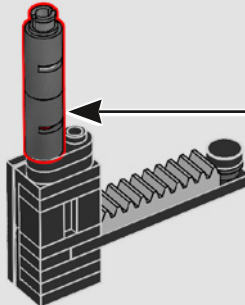

189

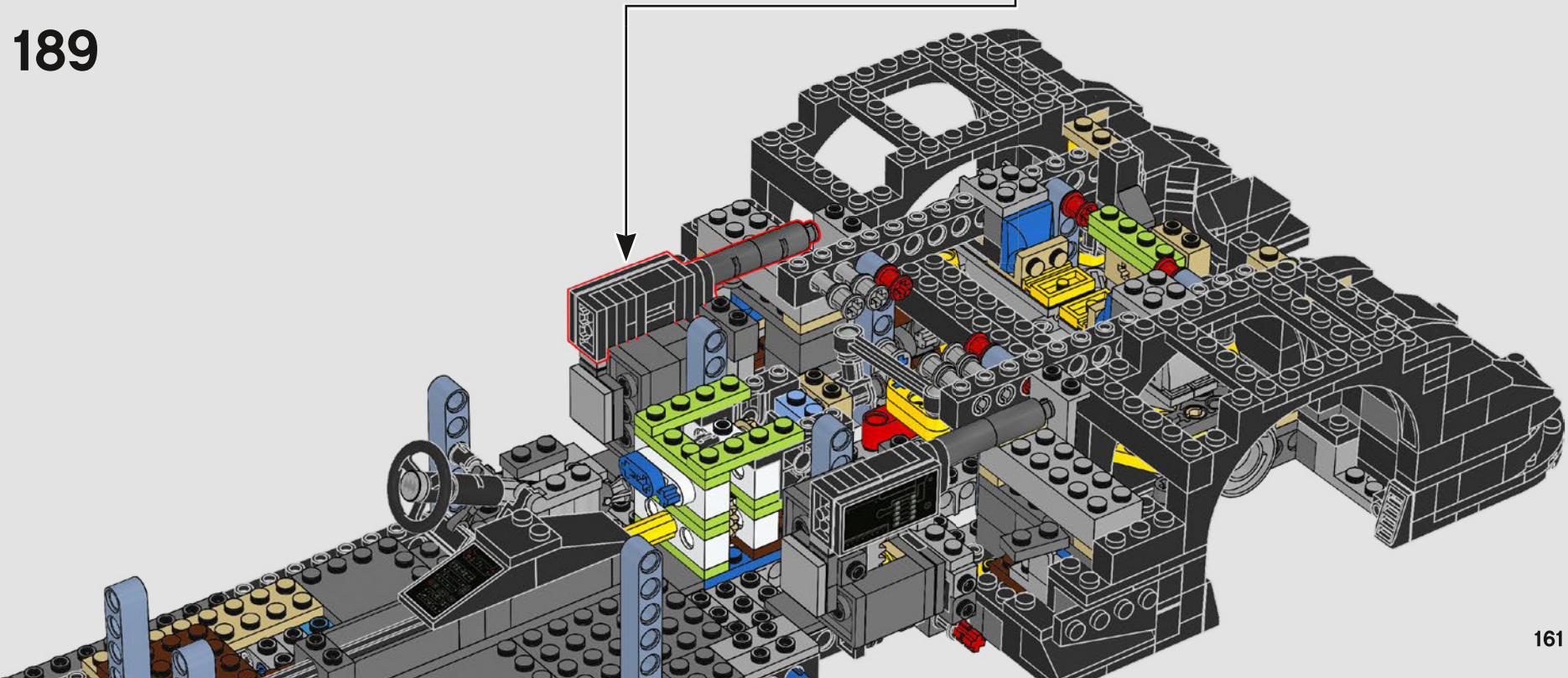

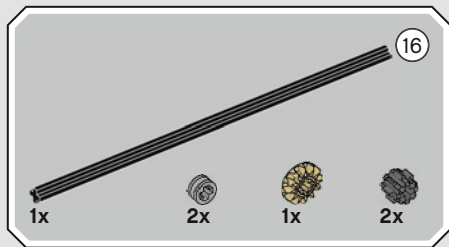

190

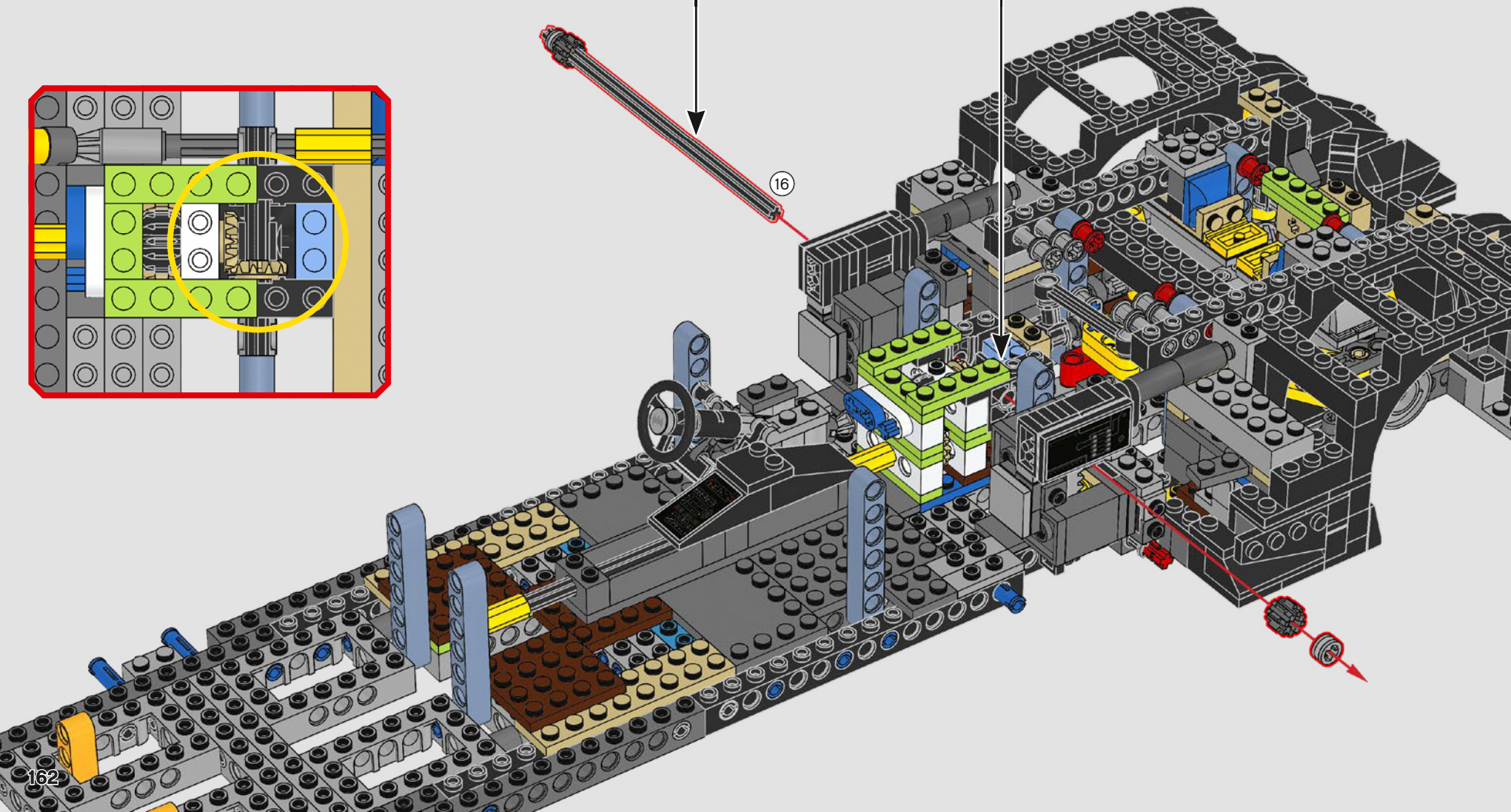
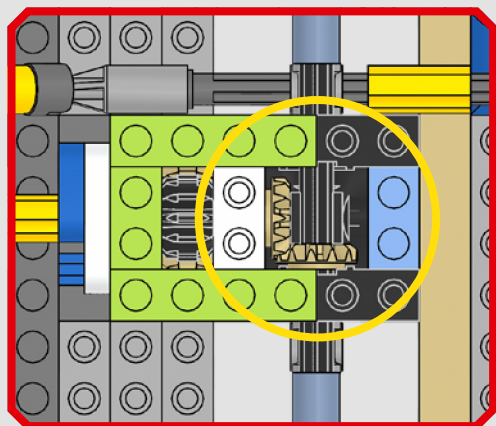

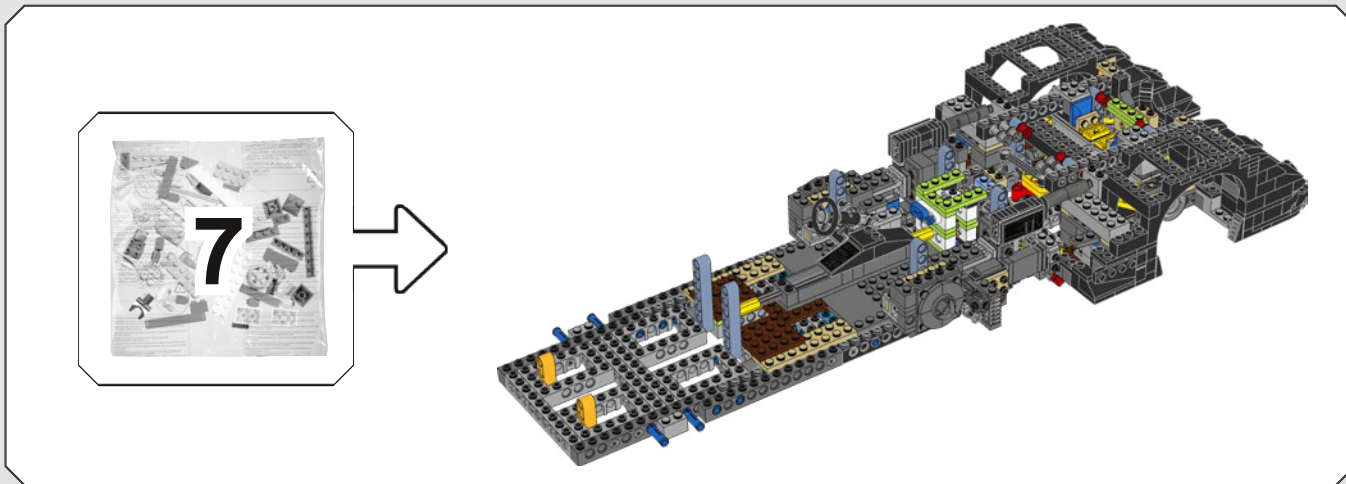
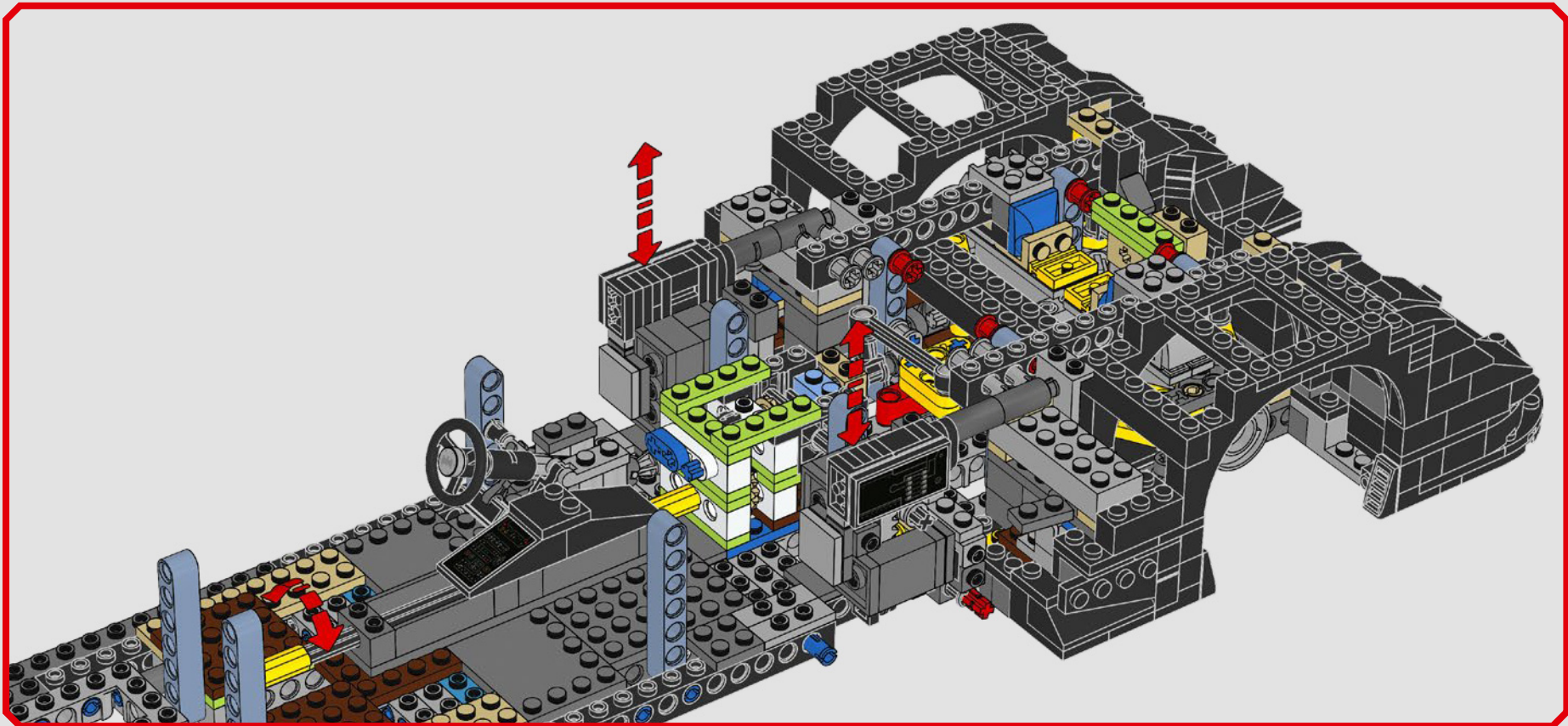

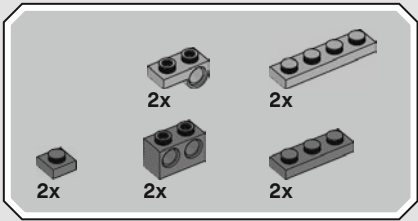

# 191

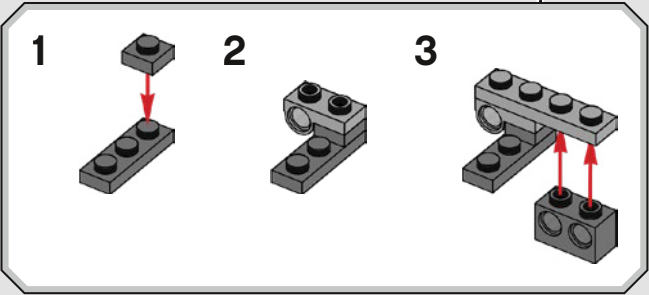
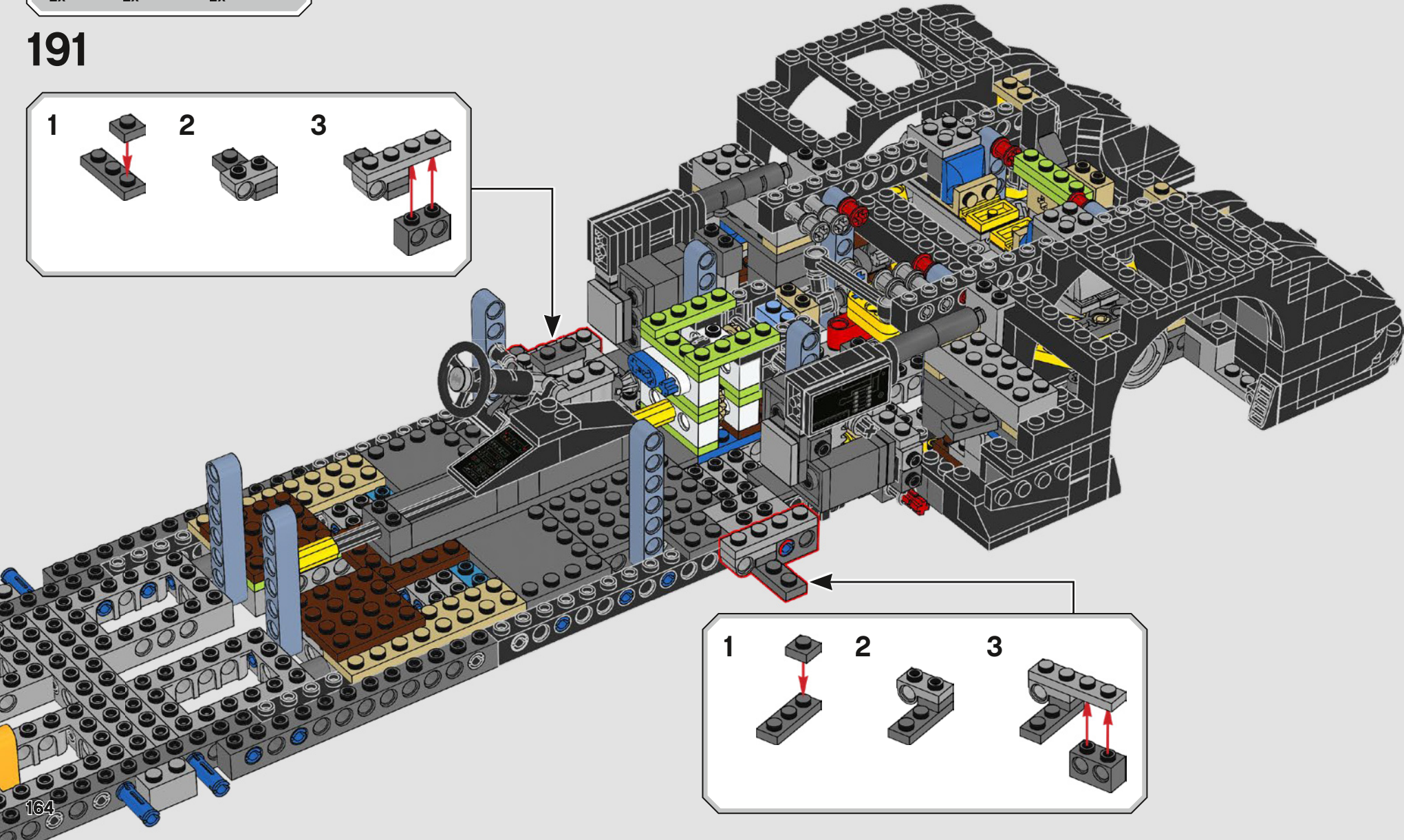
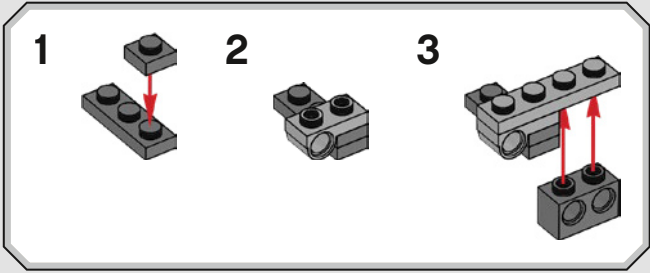

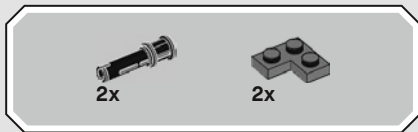

192

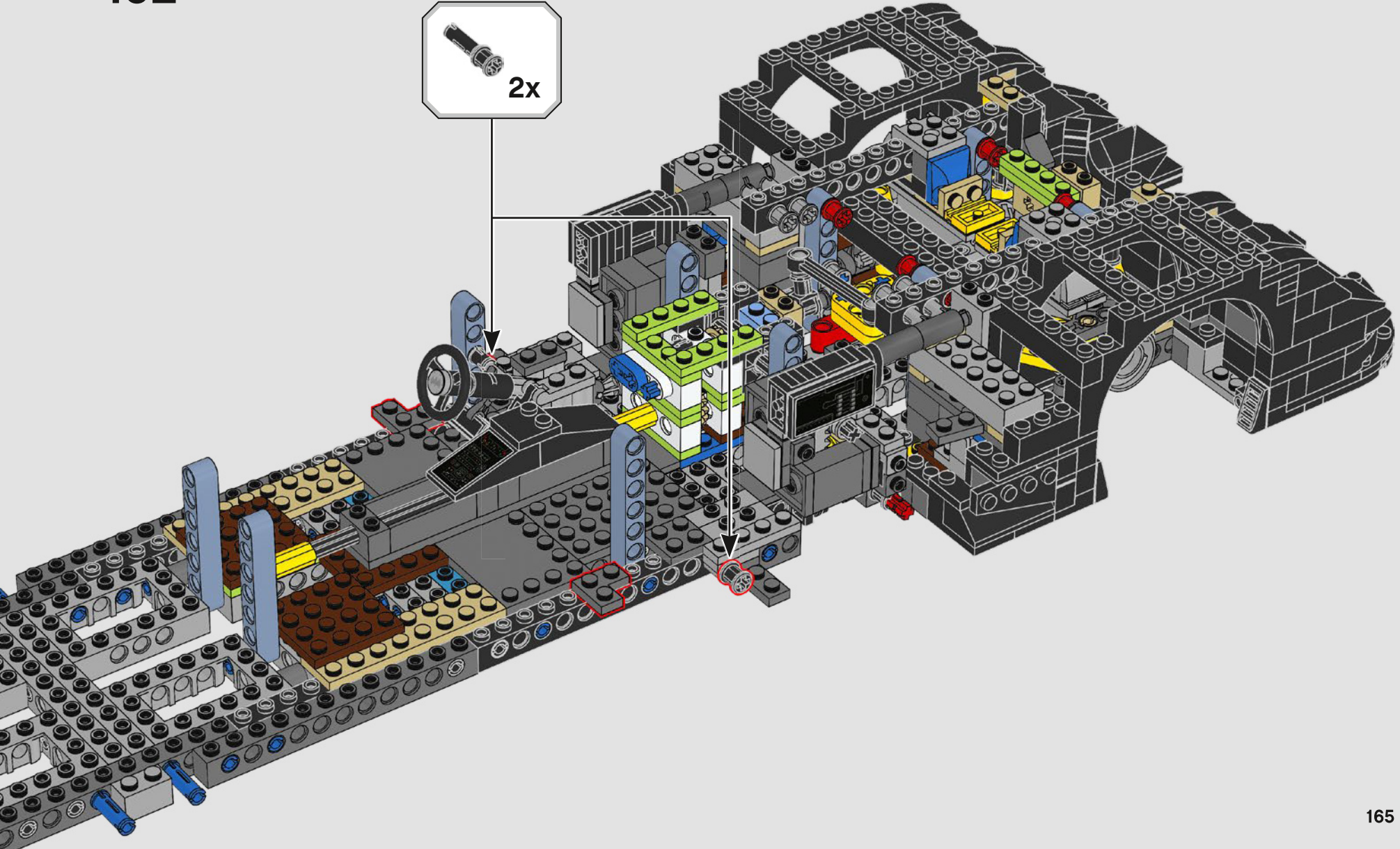

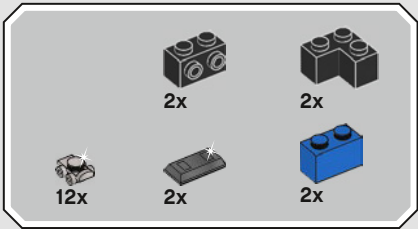

# 193

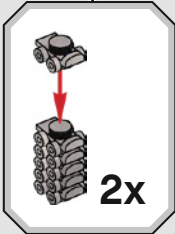
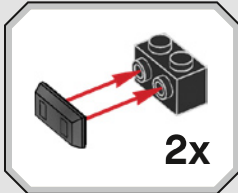
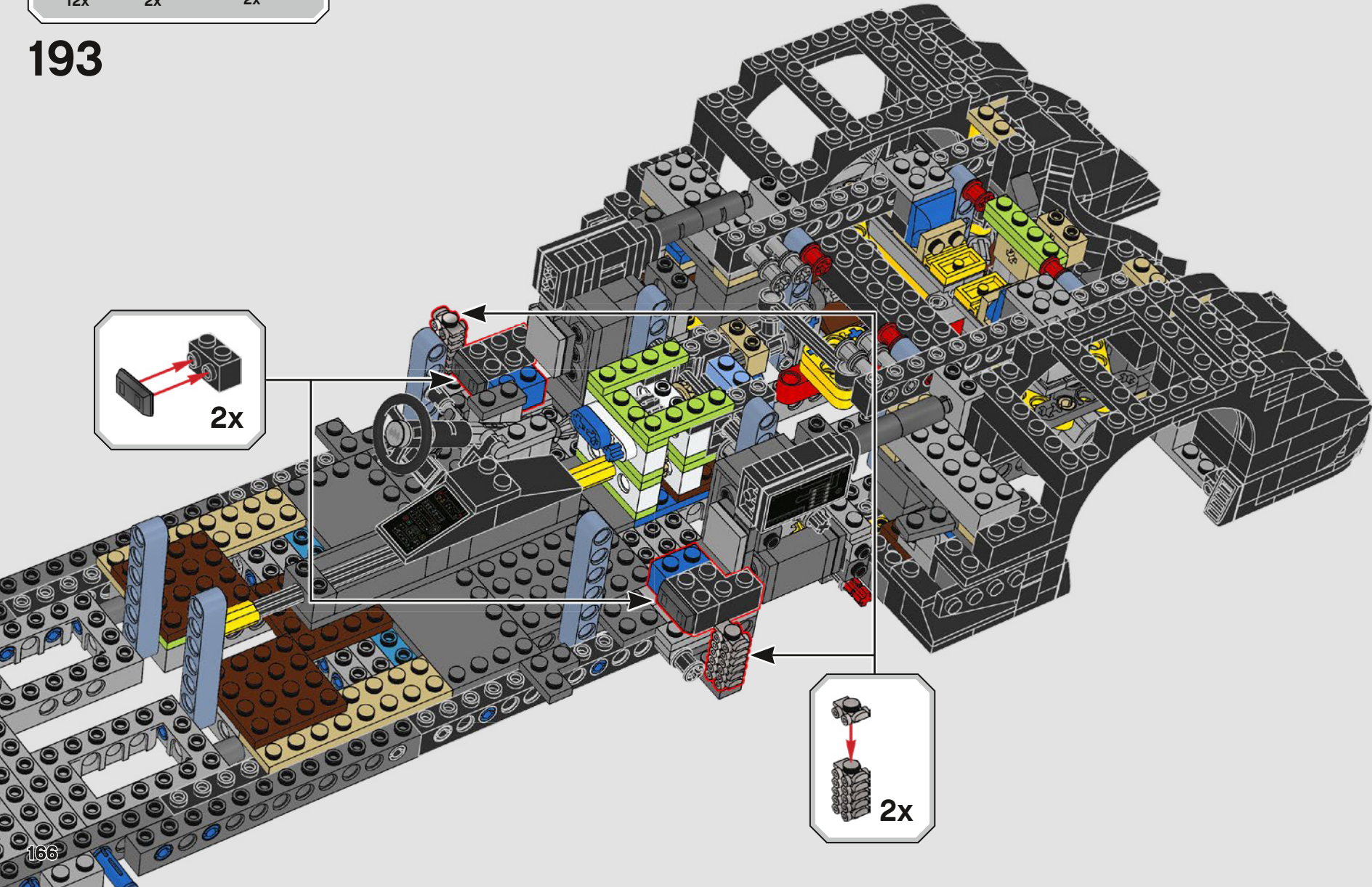

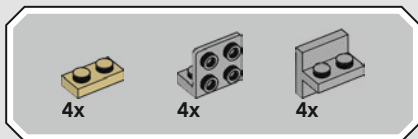

194

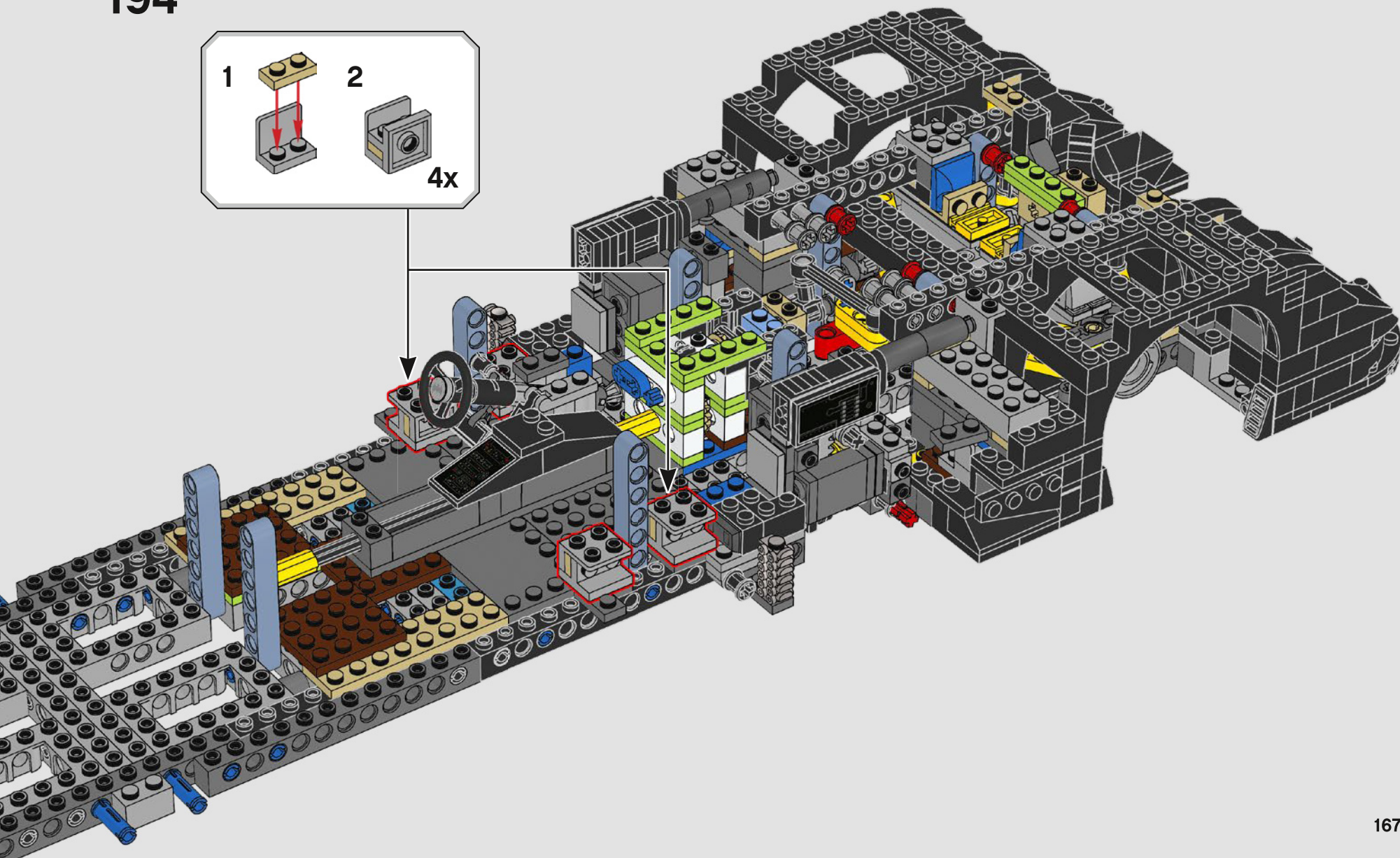
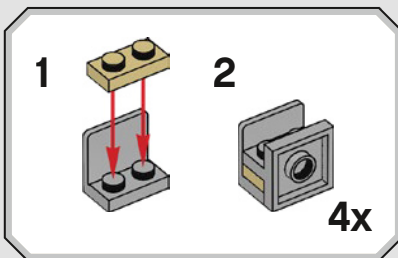



# 195

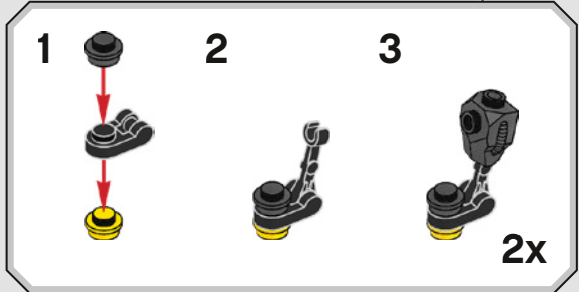
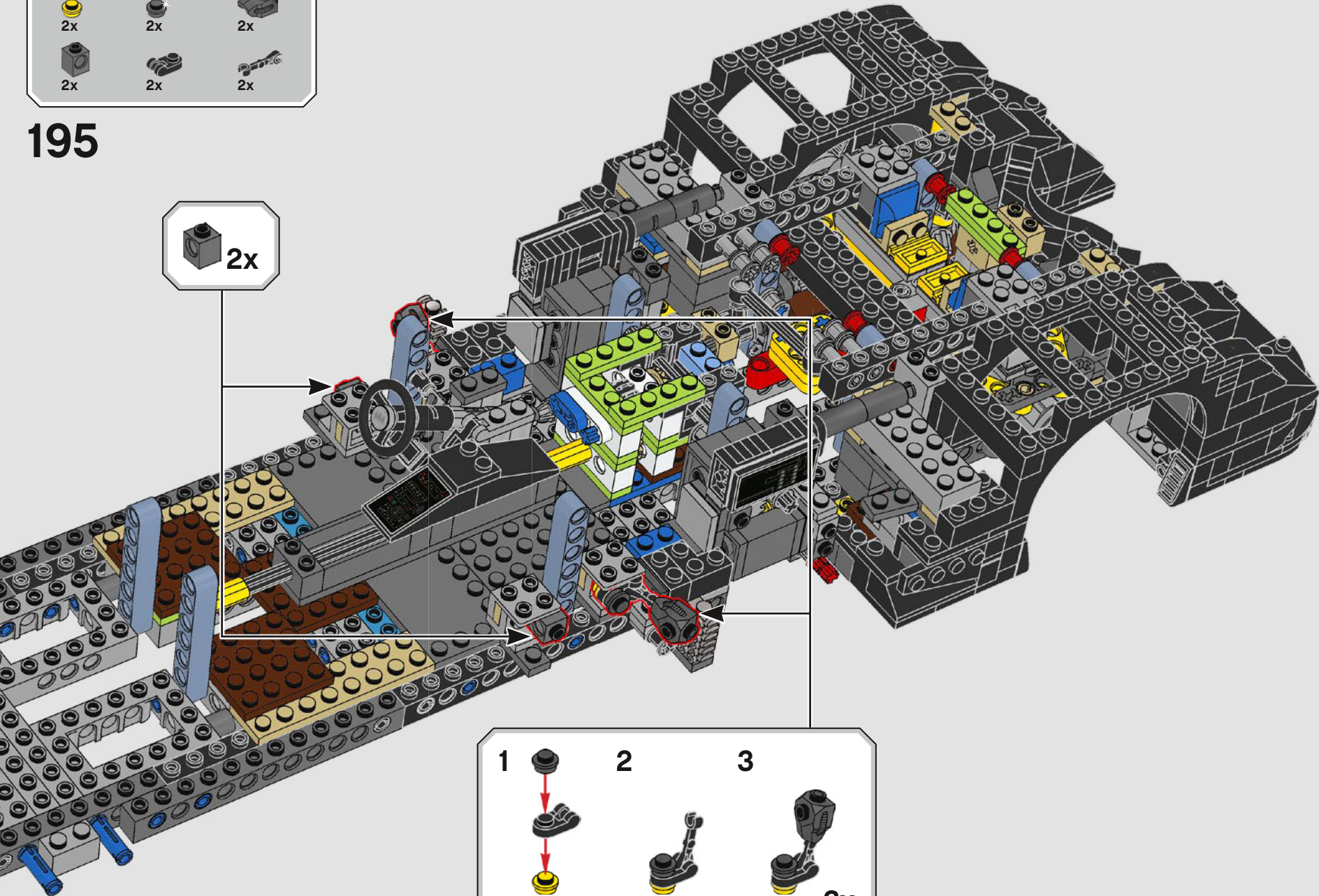
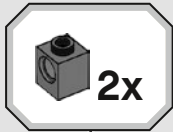



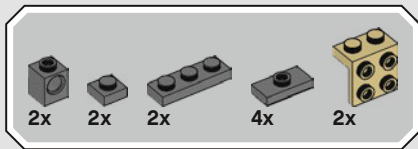

196

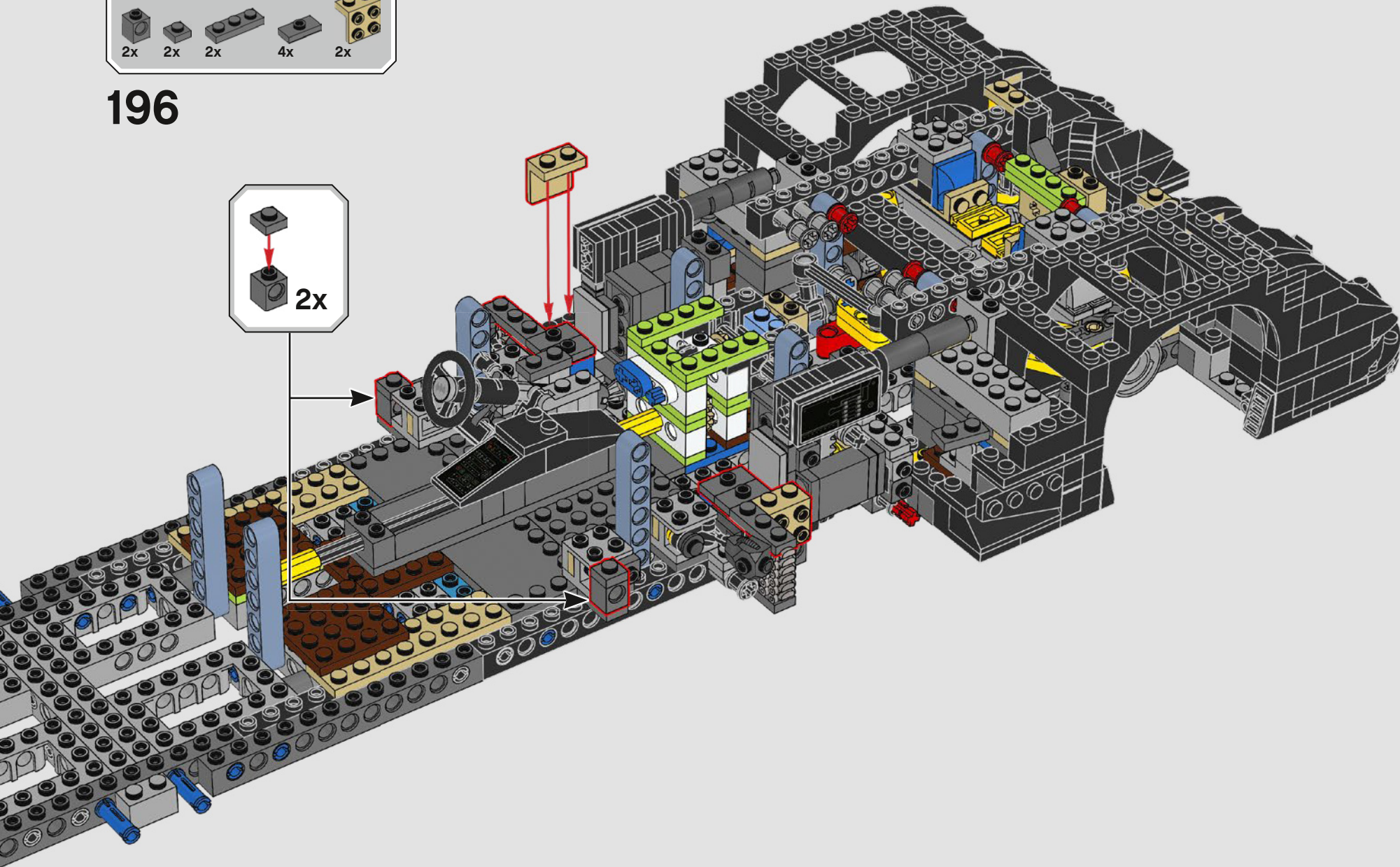
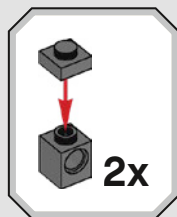

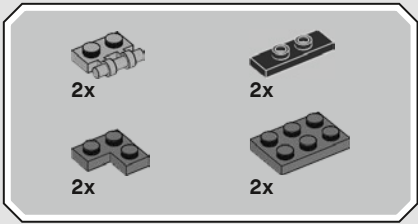

197

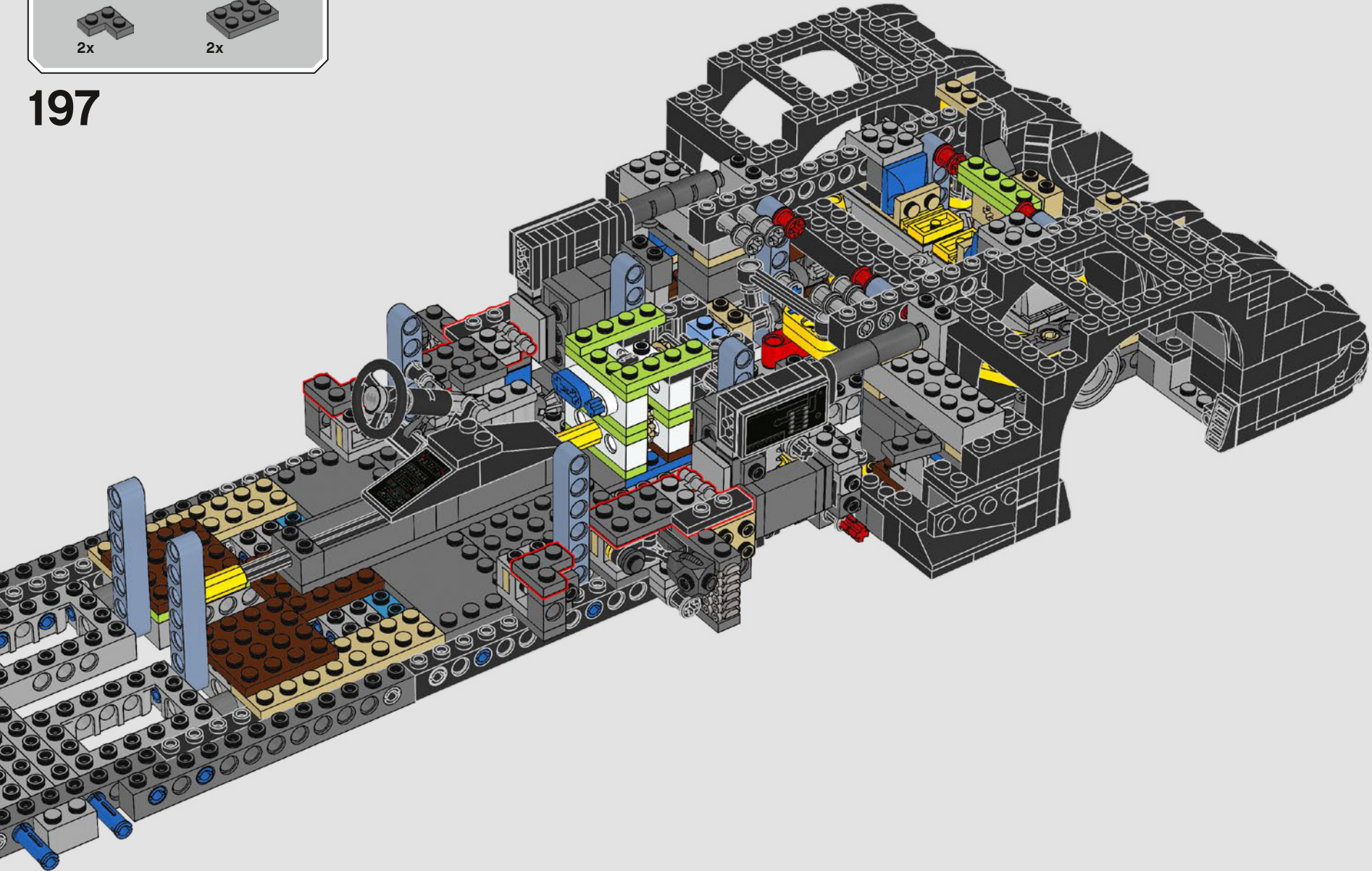

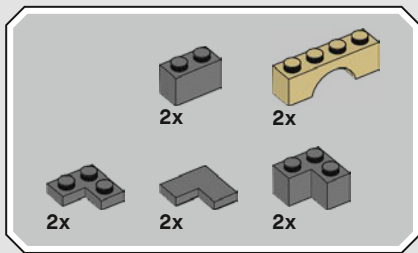

198

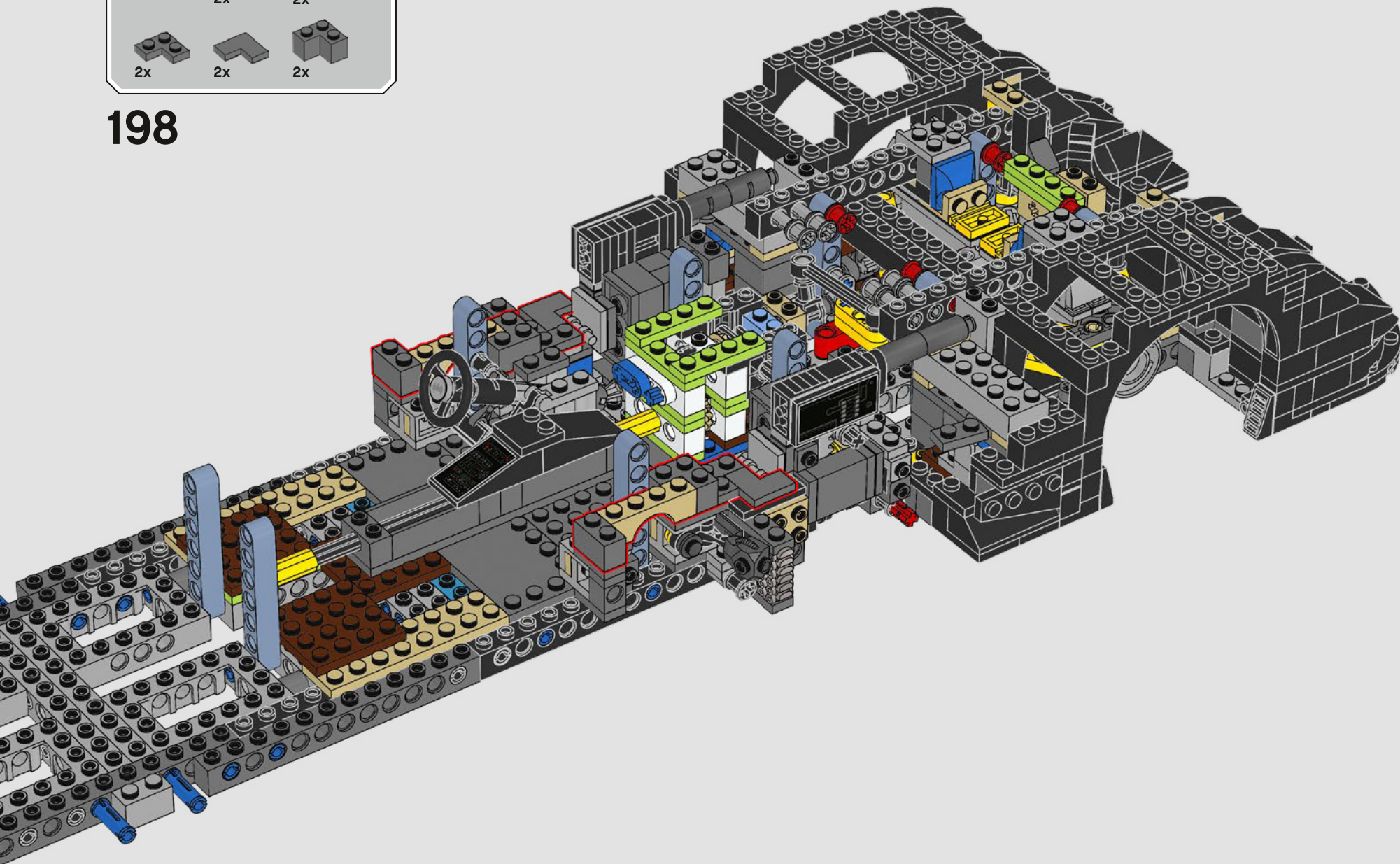

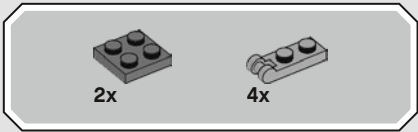

# 199

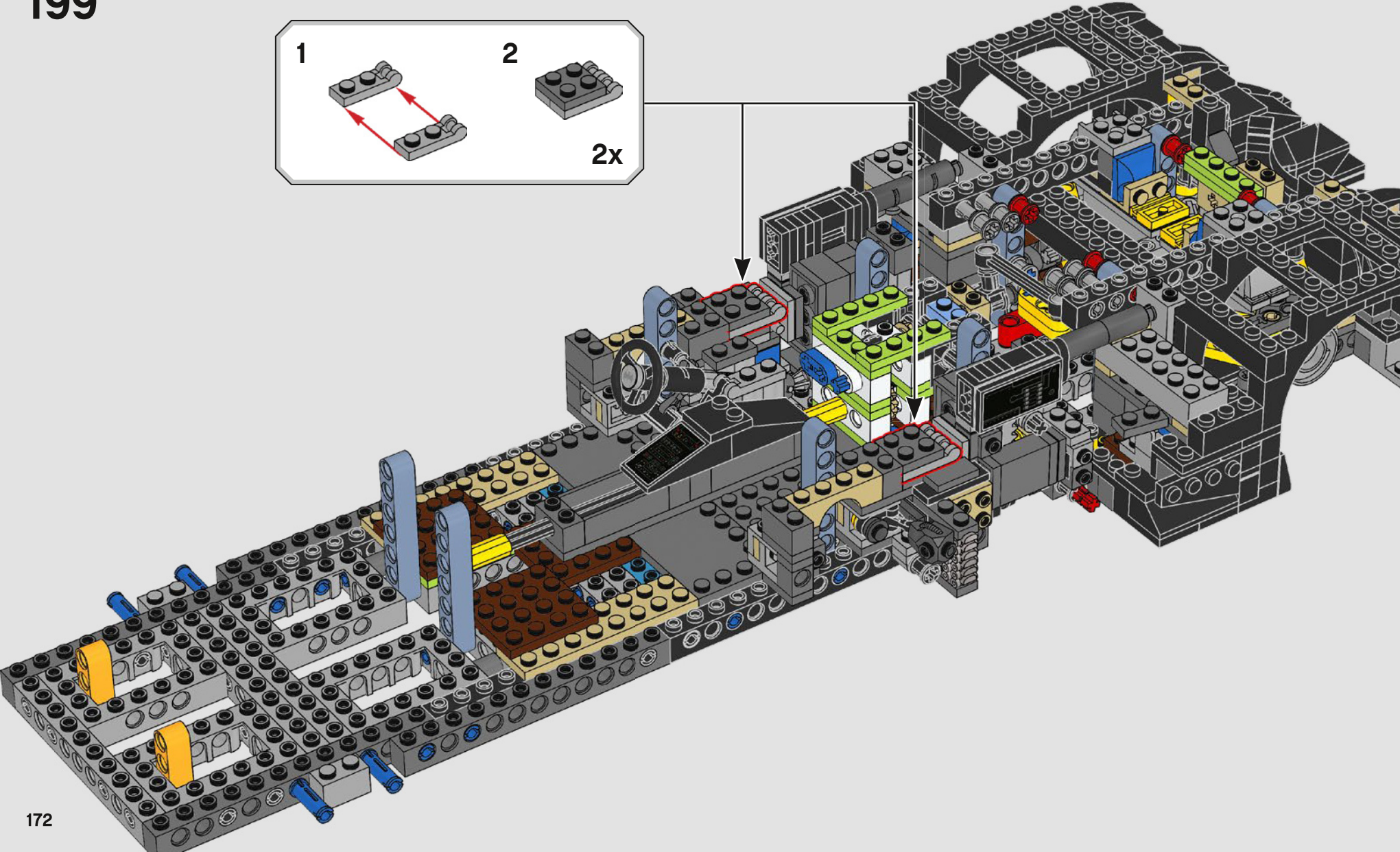
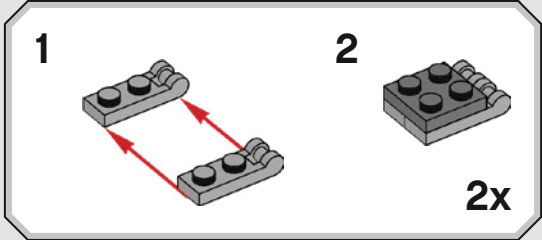

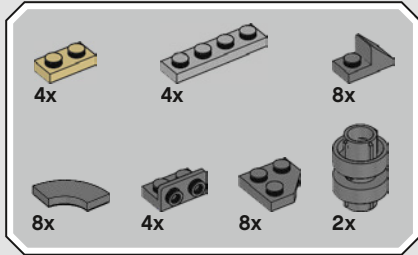
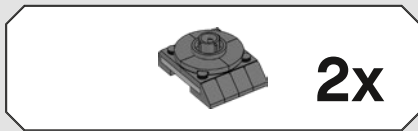

200

1

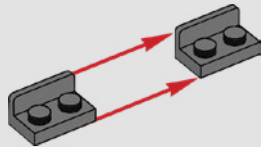

2

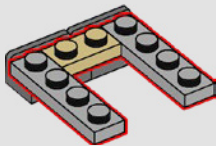

3

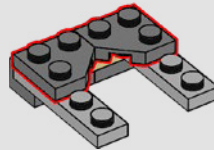

4

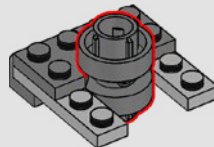

5

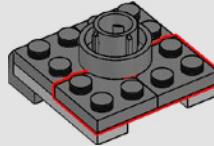

6

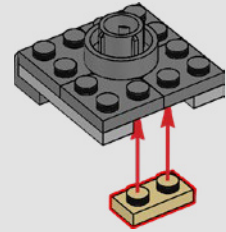

7

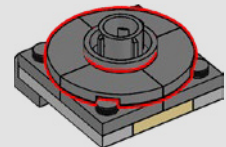

8

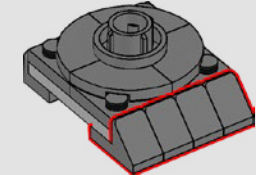

2x

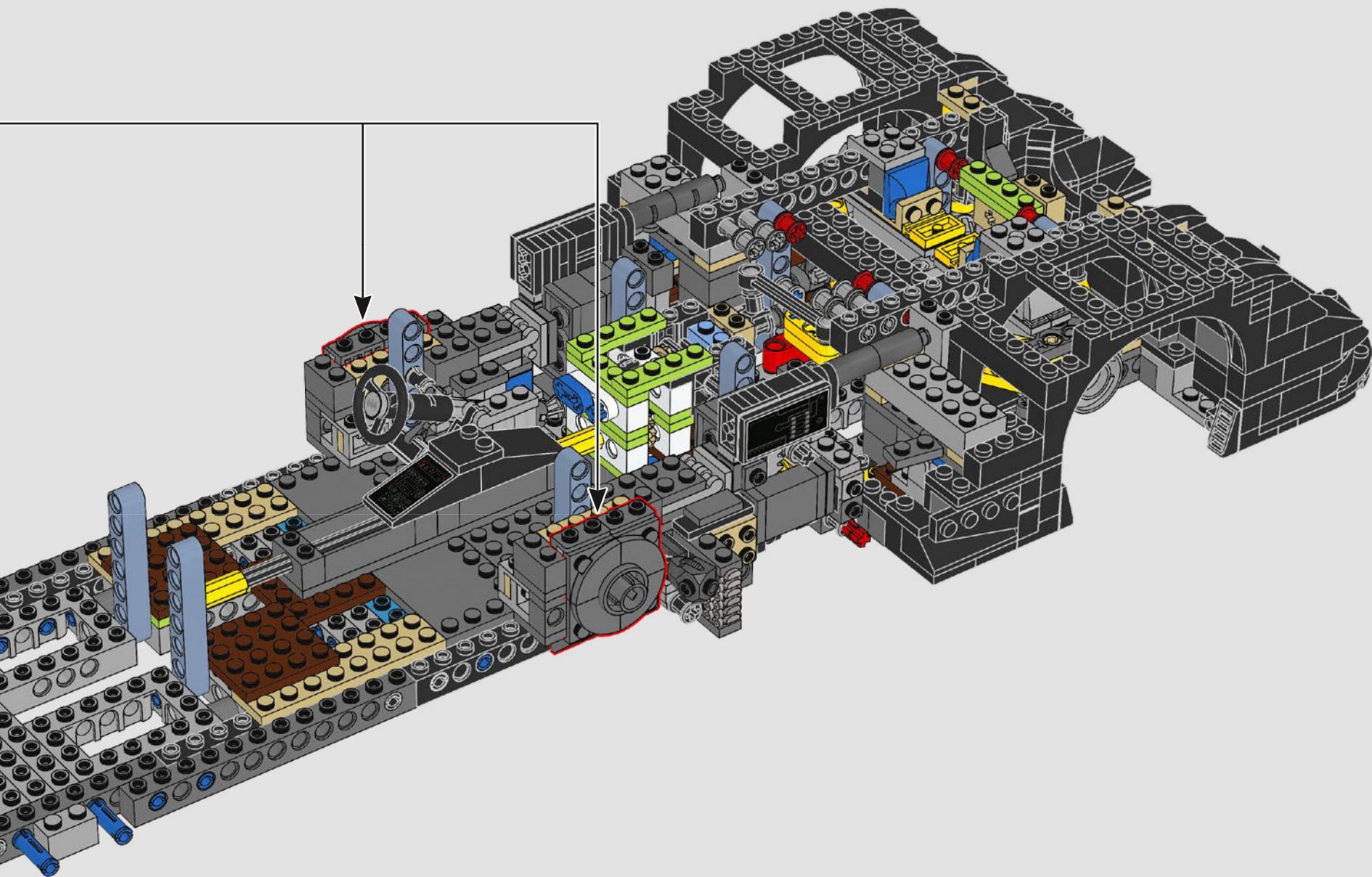

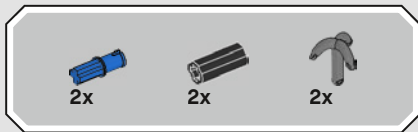

201

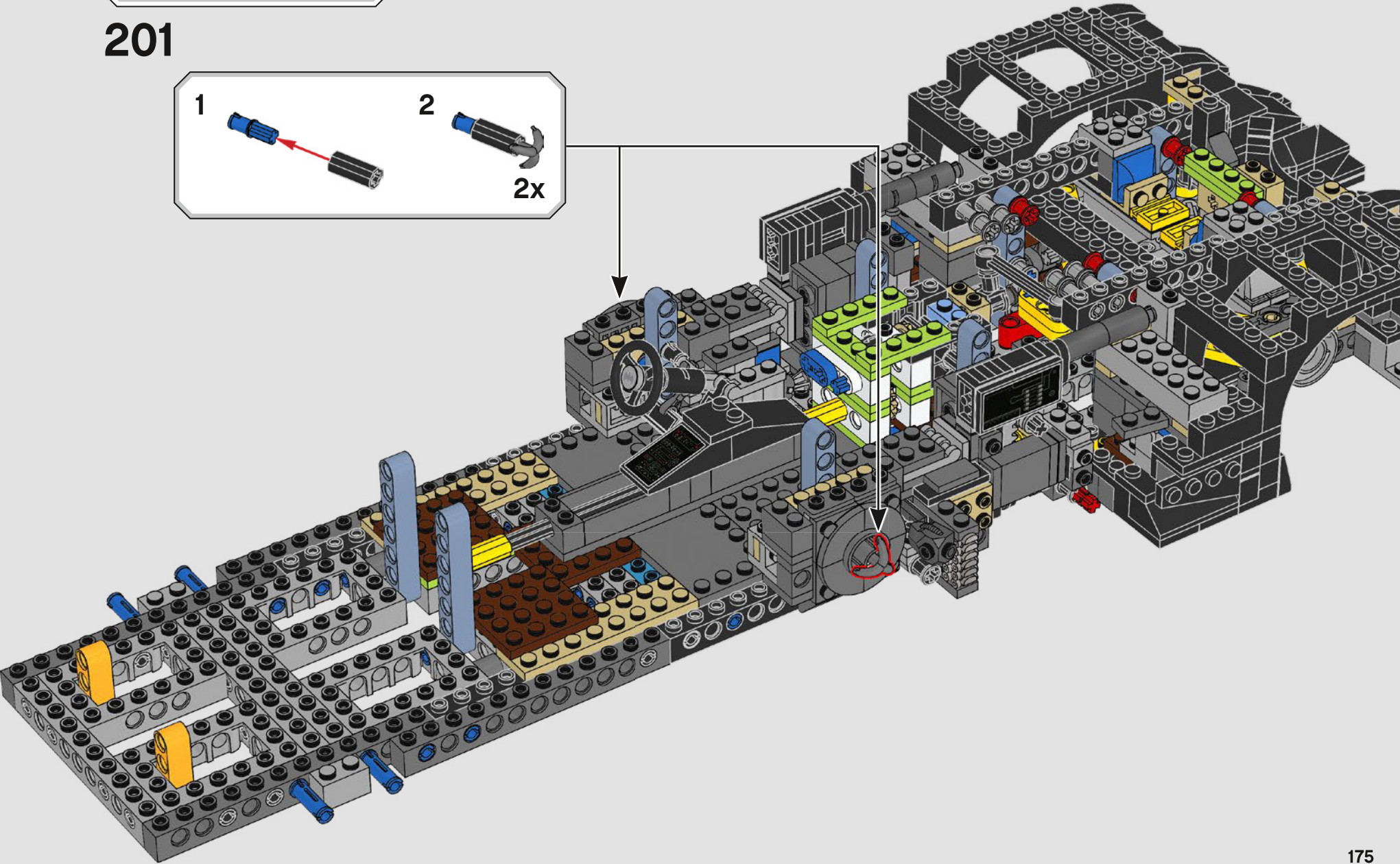
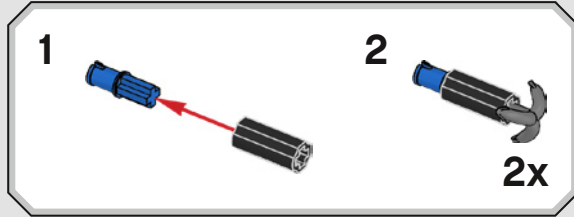



1x

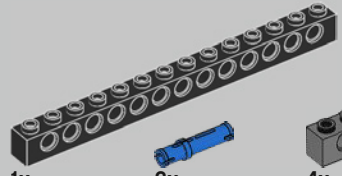
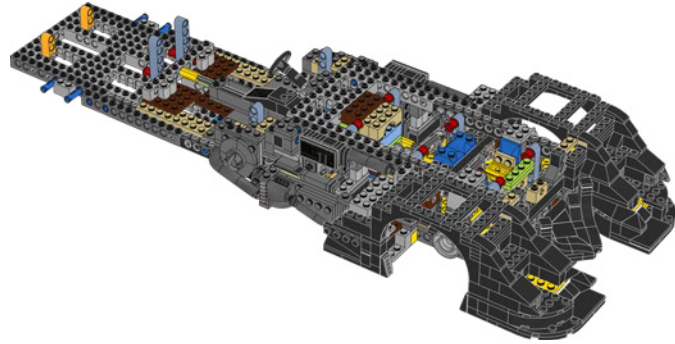

1x

2x

4x

202

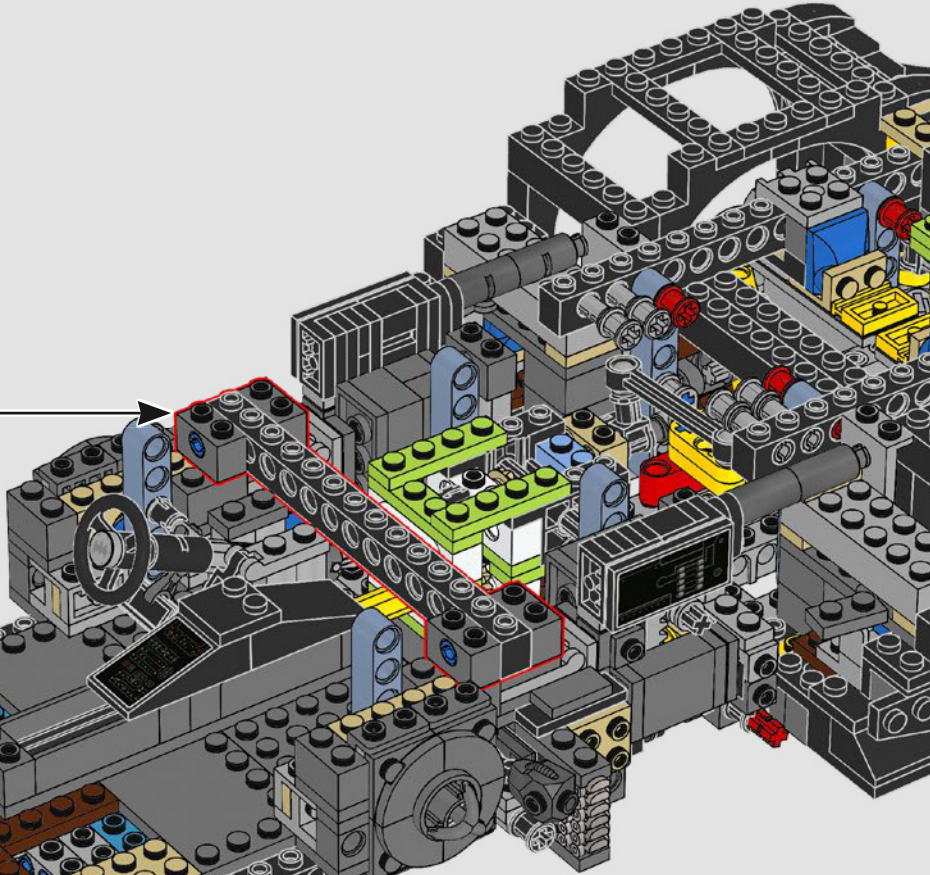
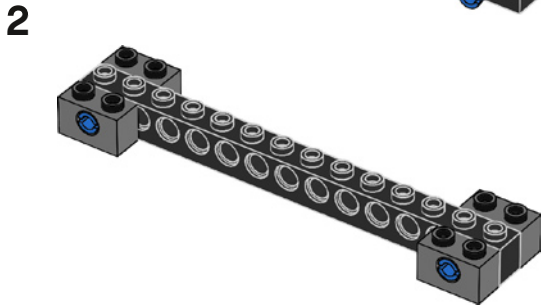
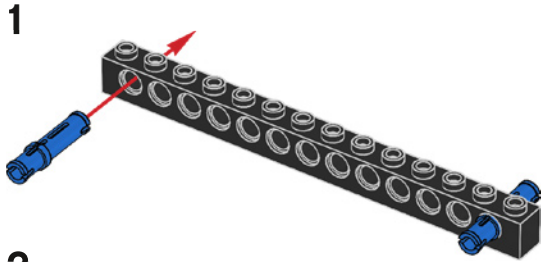



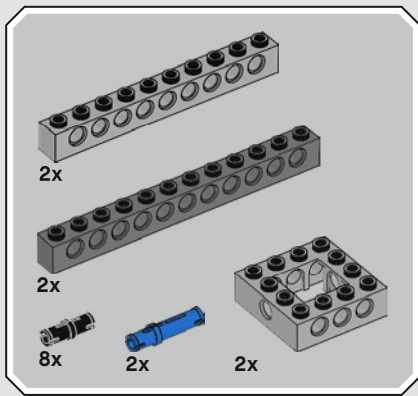

# 203

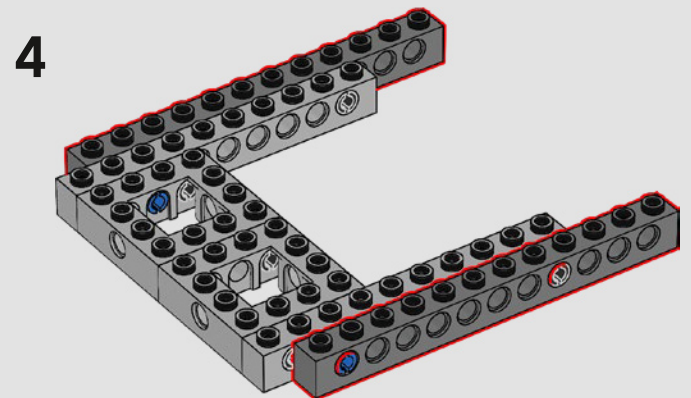
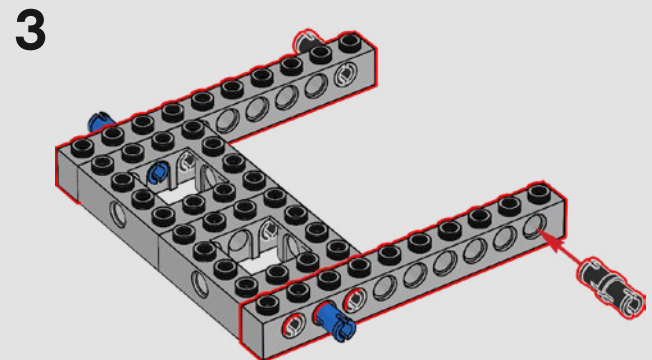
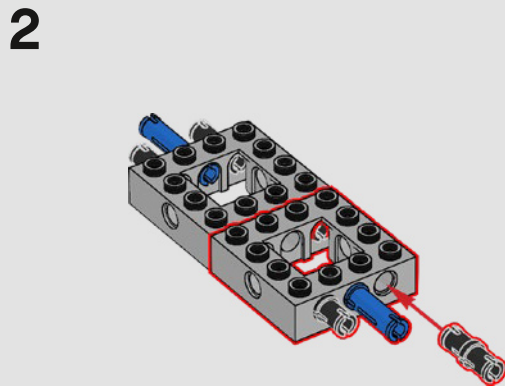
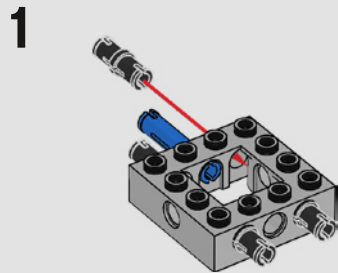

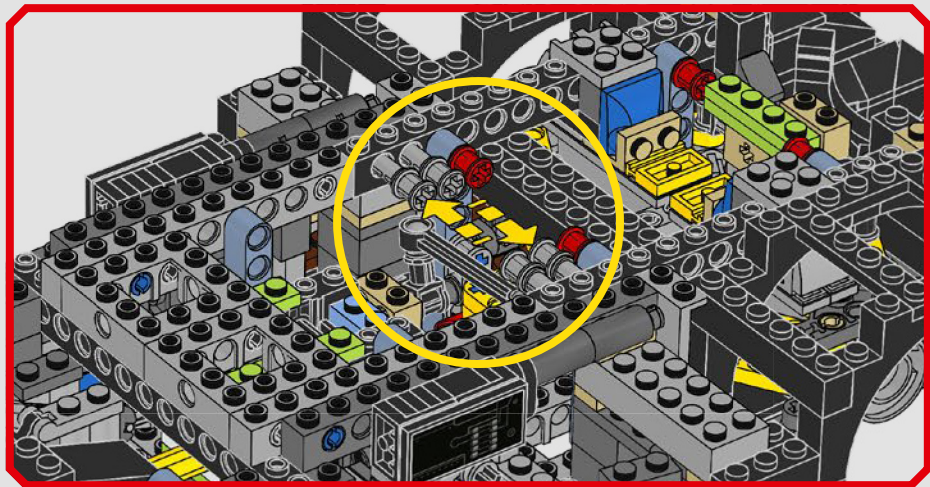
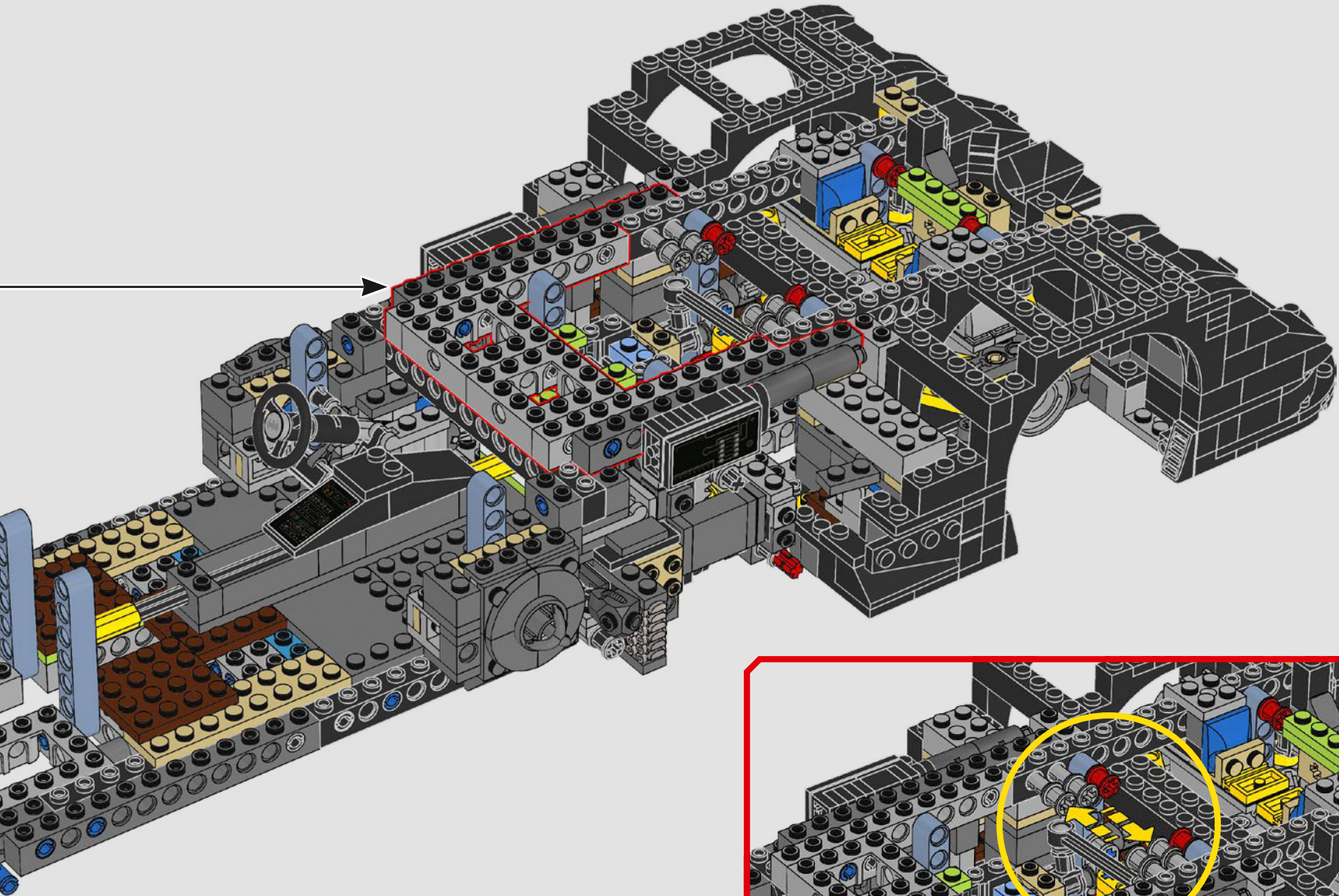

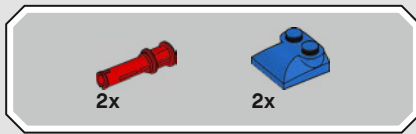

204

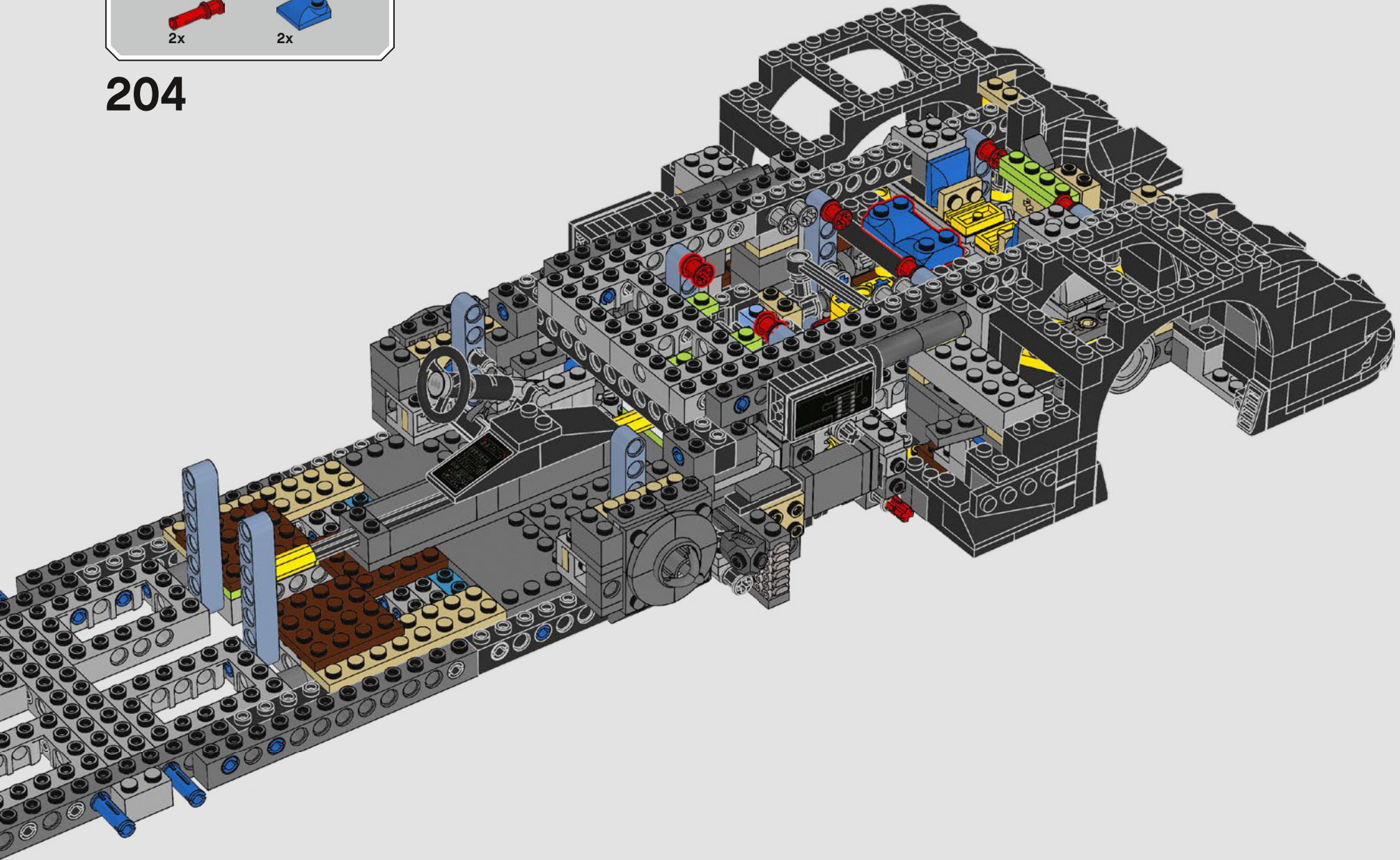

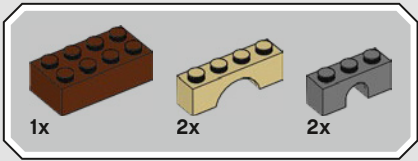

205

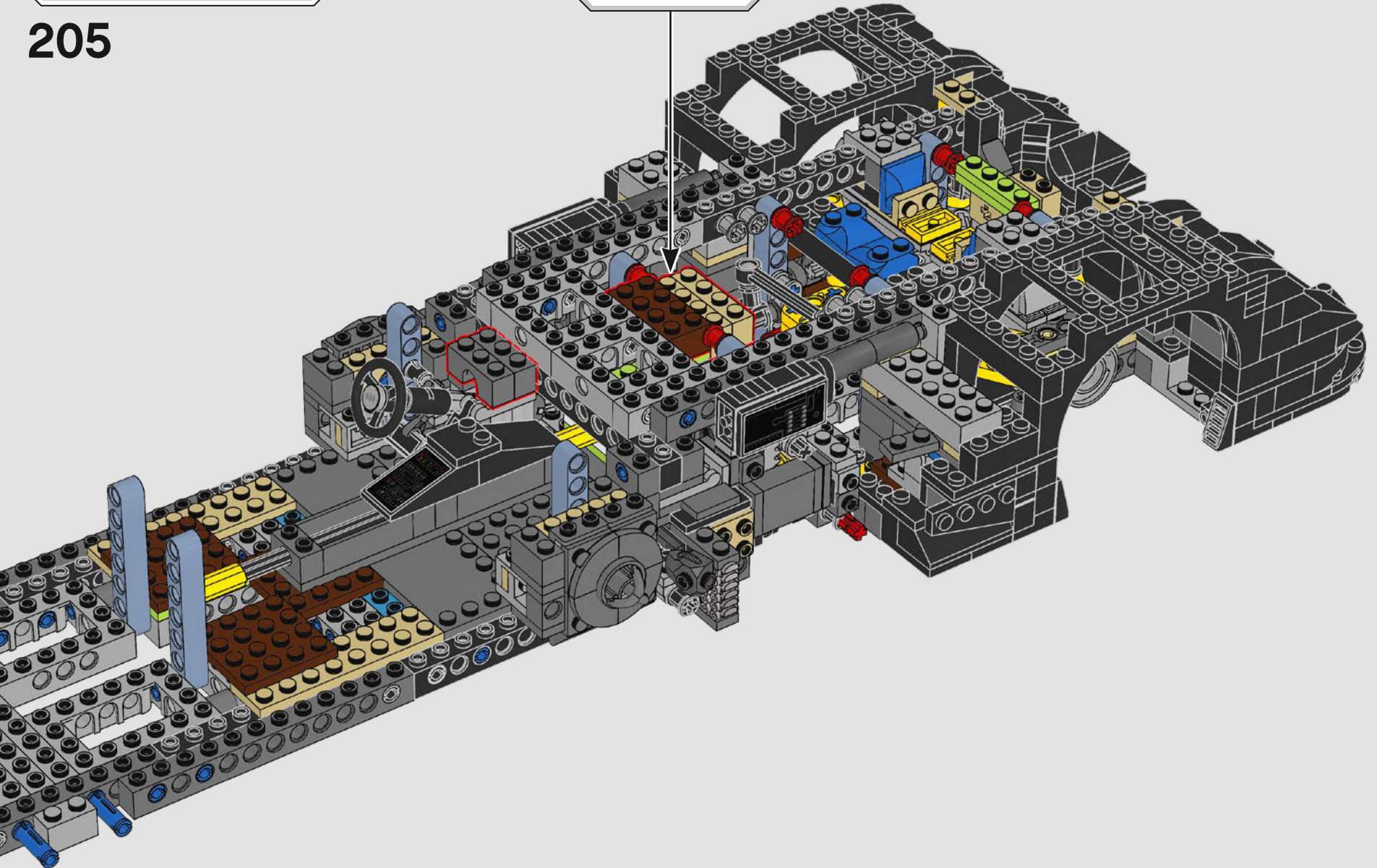
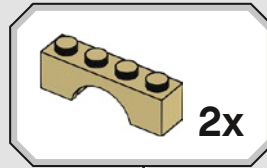

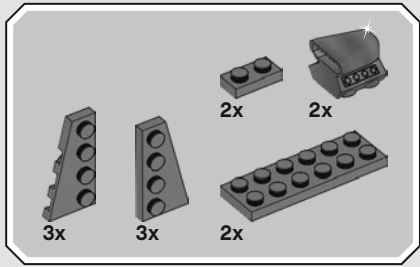

206

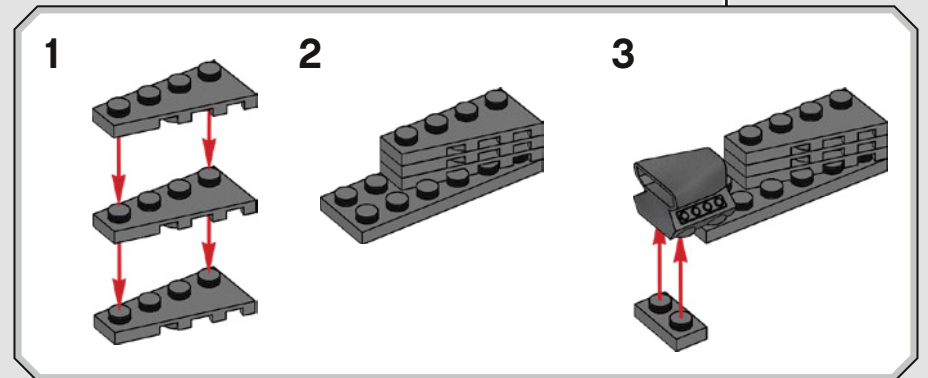
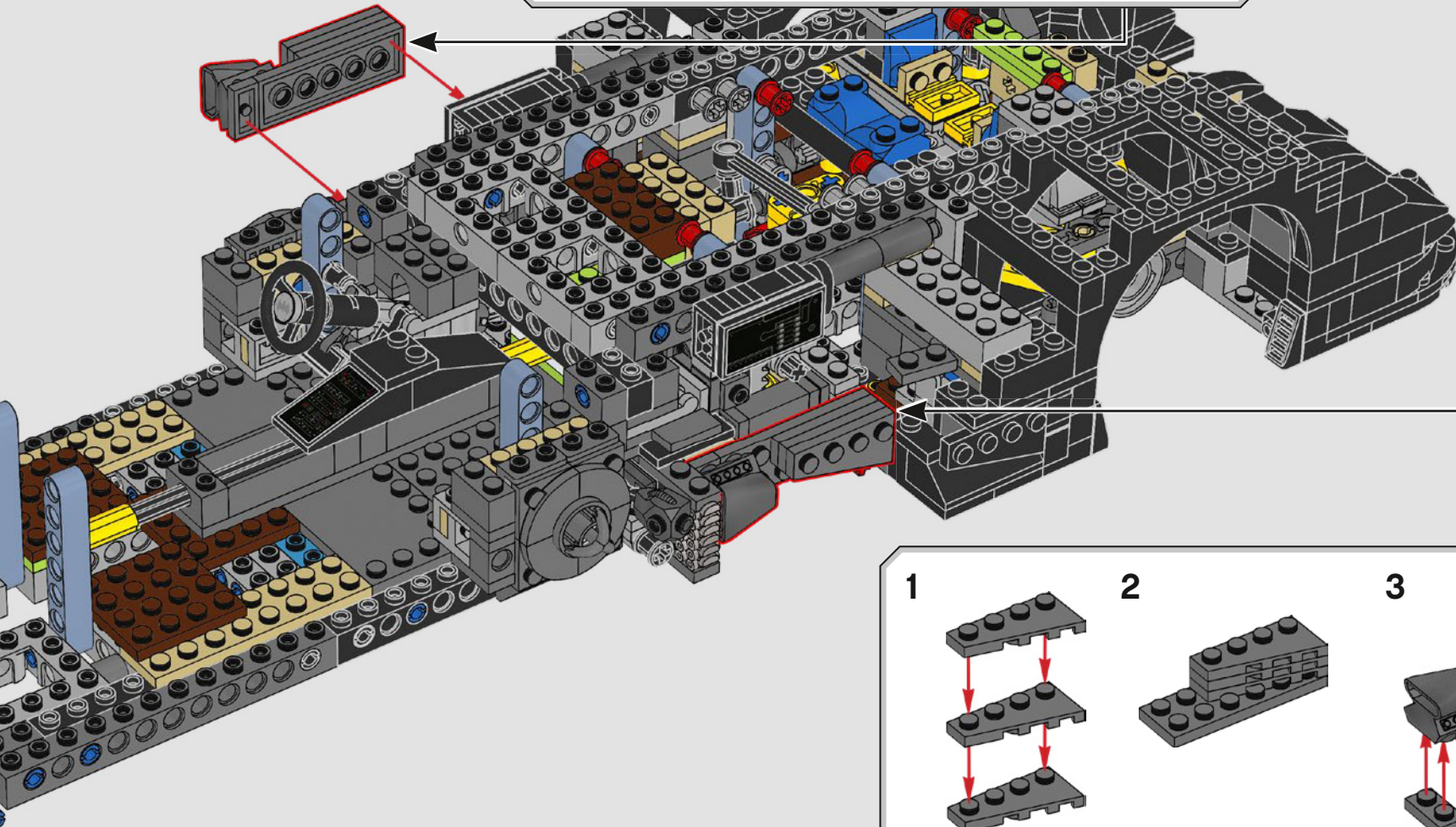
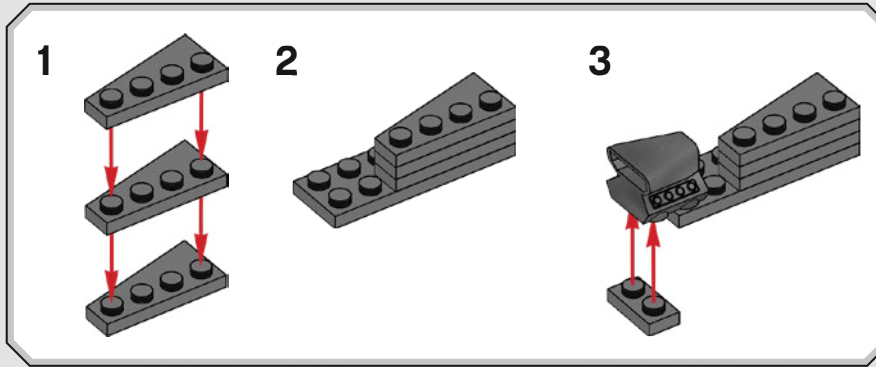

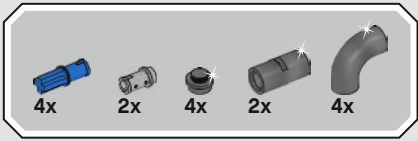

207

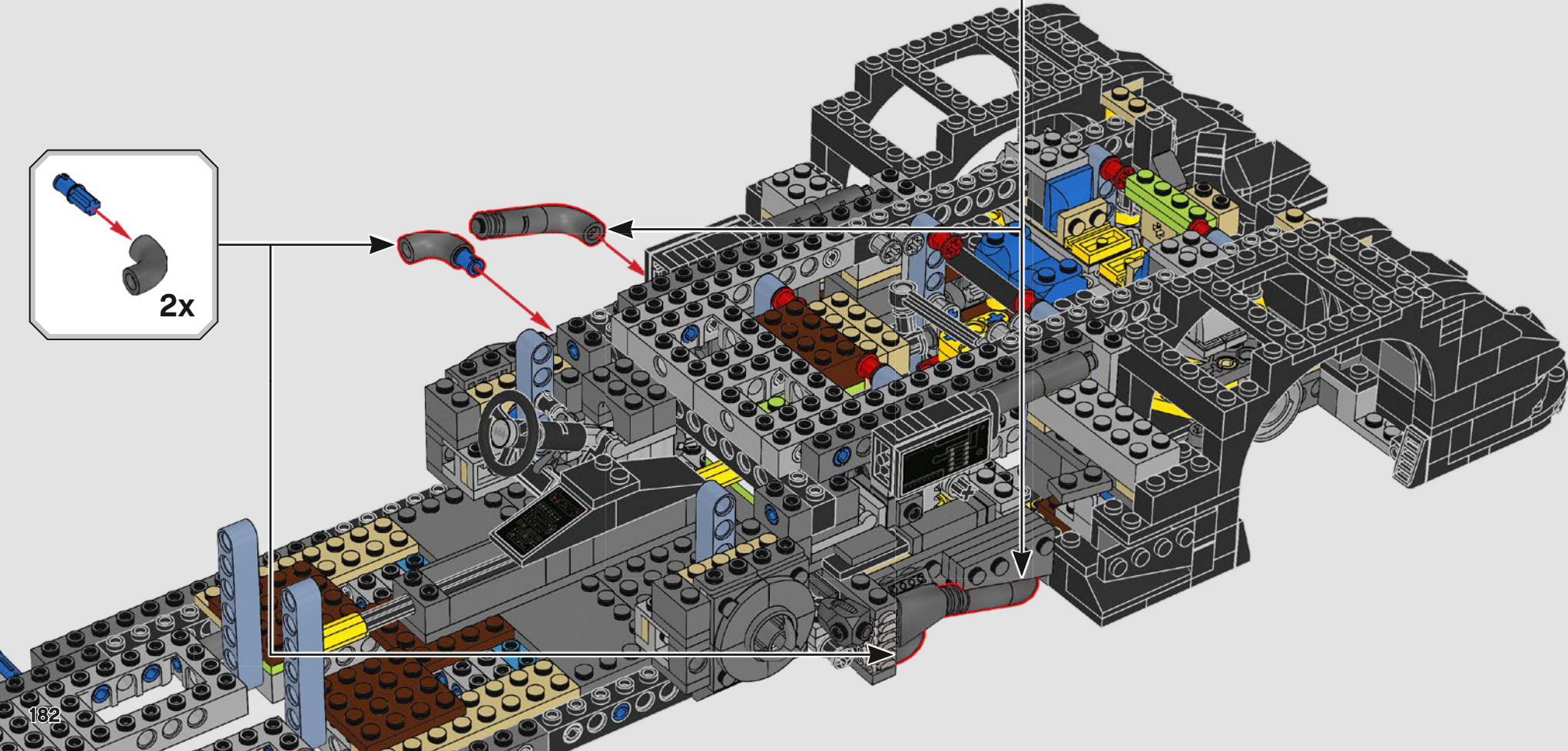
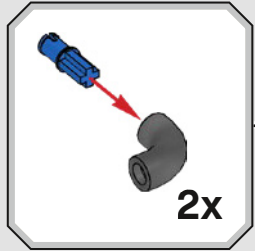
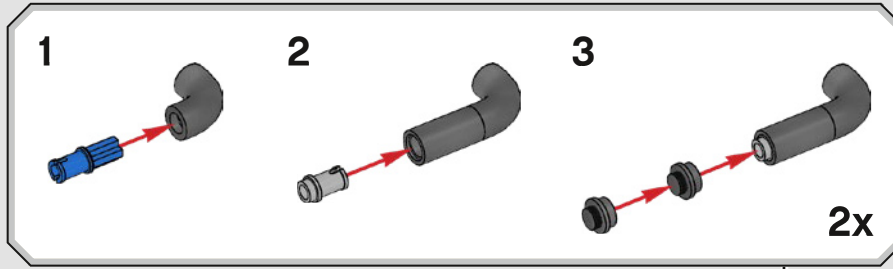

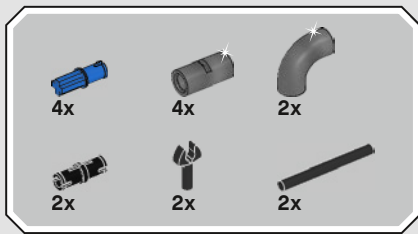

208

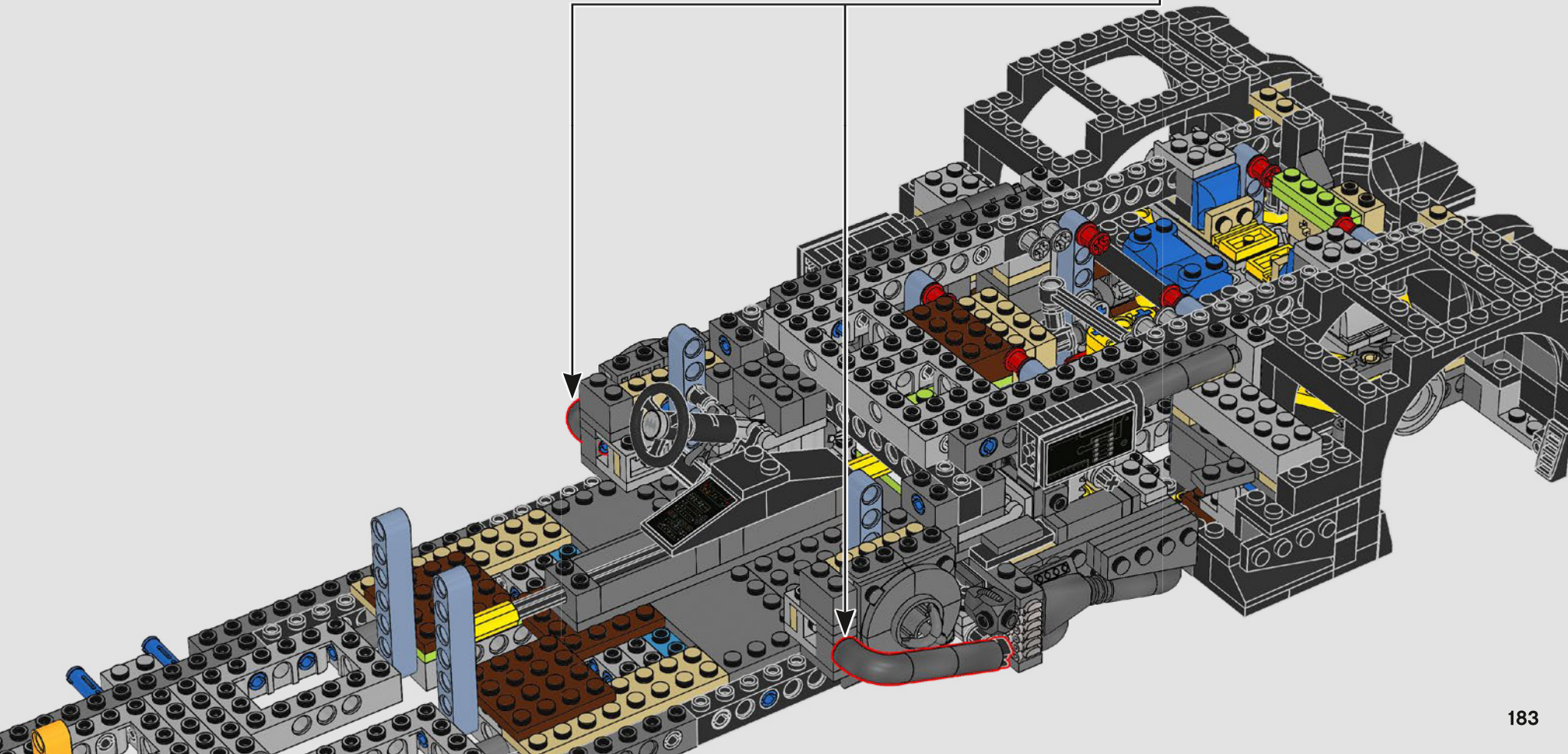
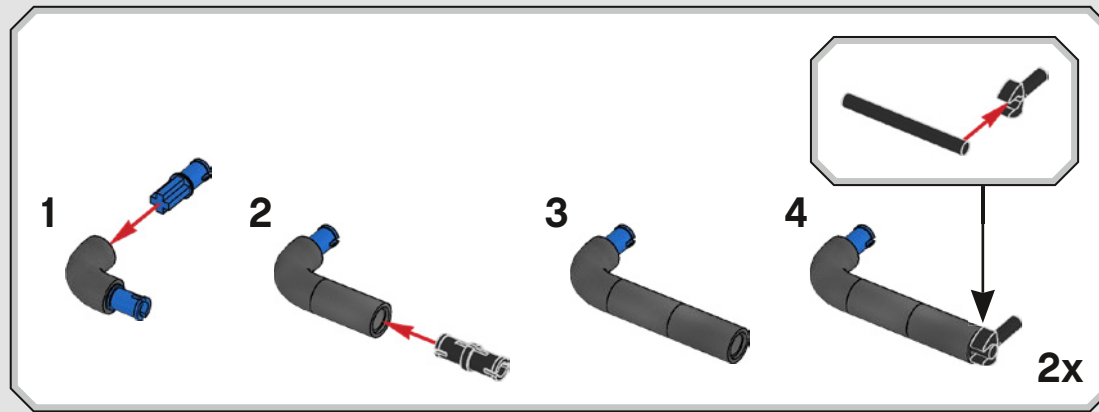

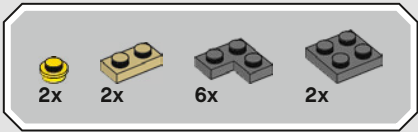

# 209

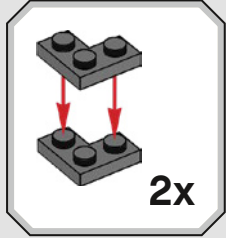
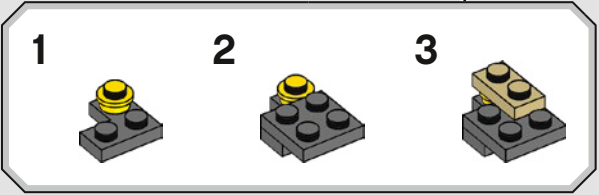
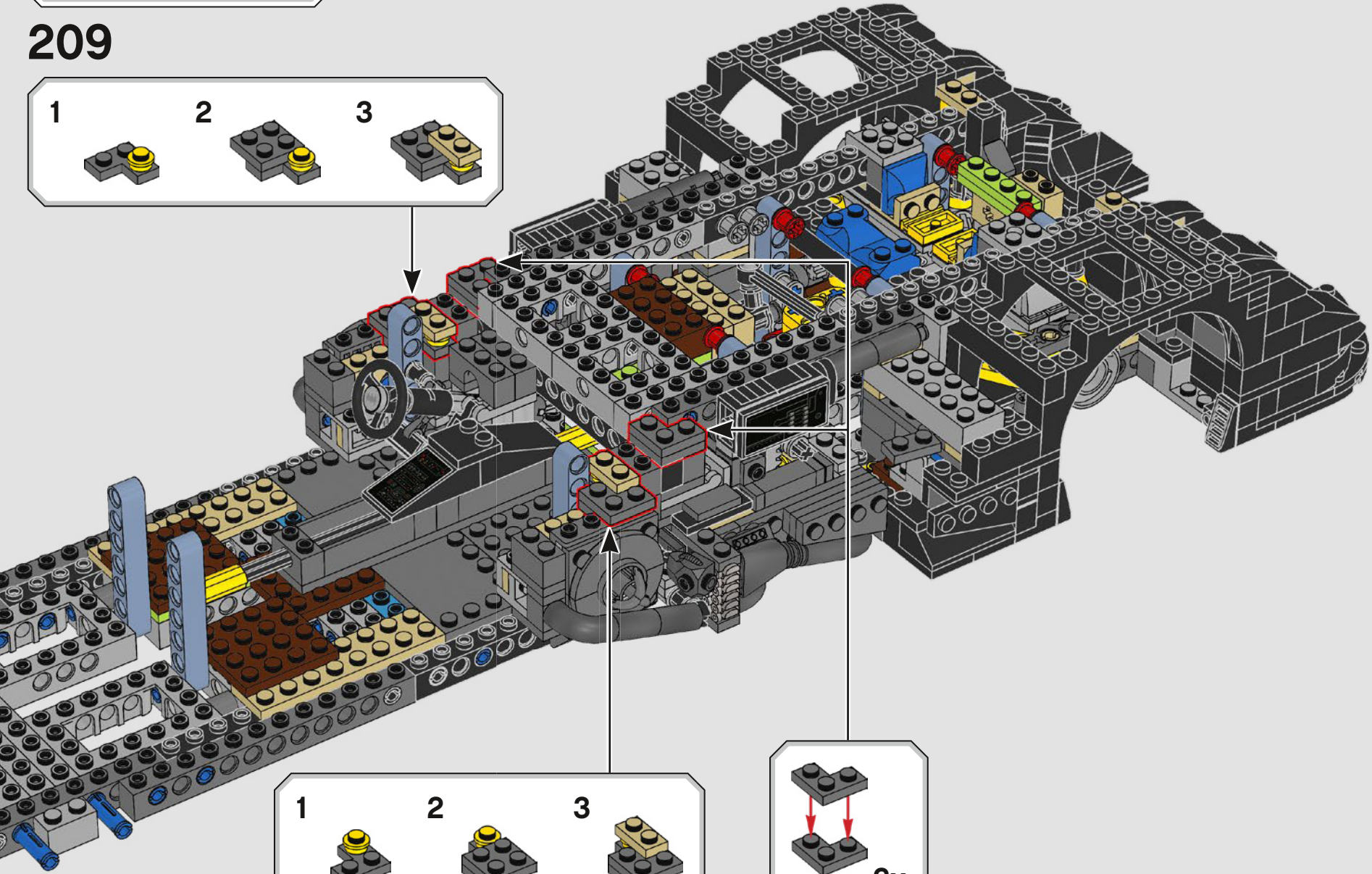
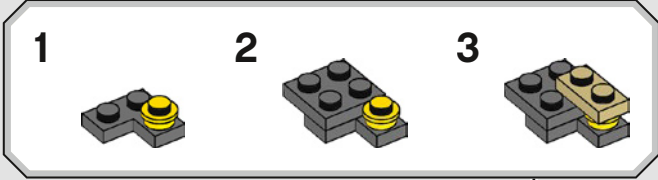



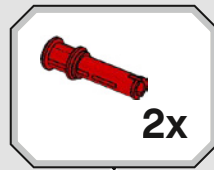
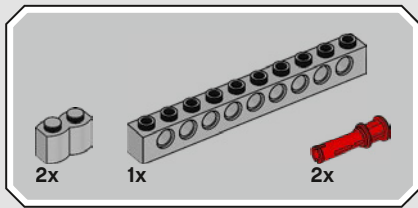

210

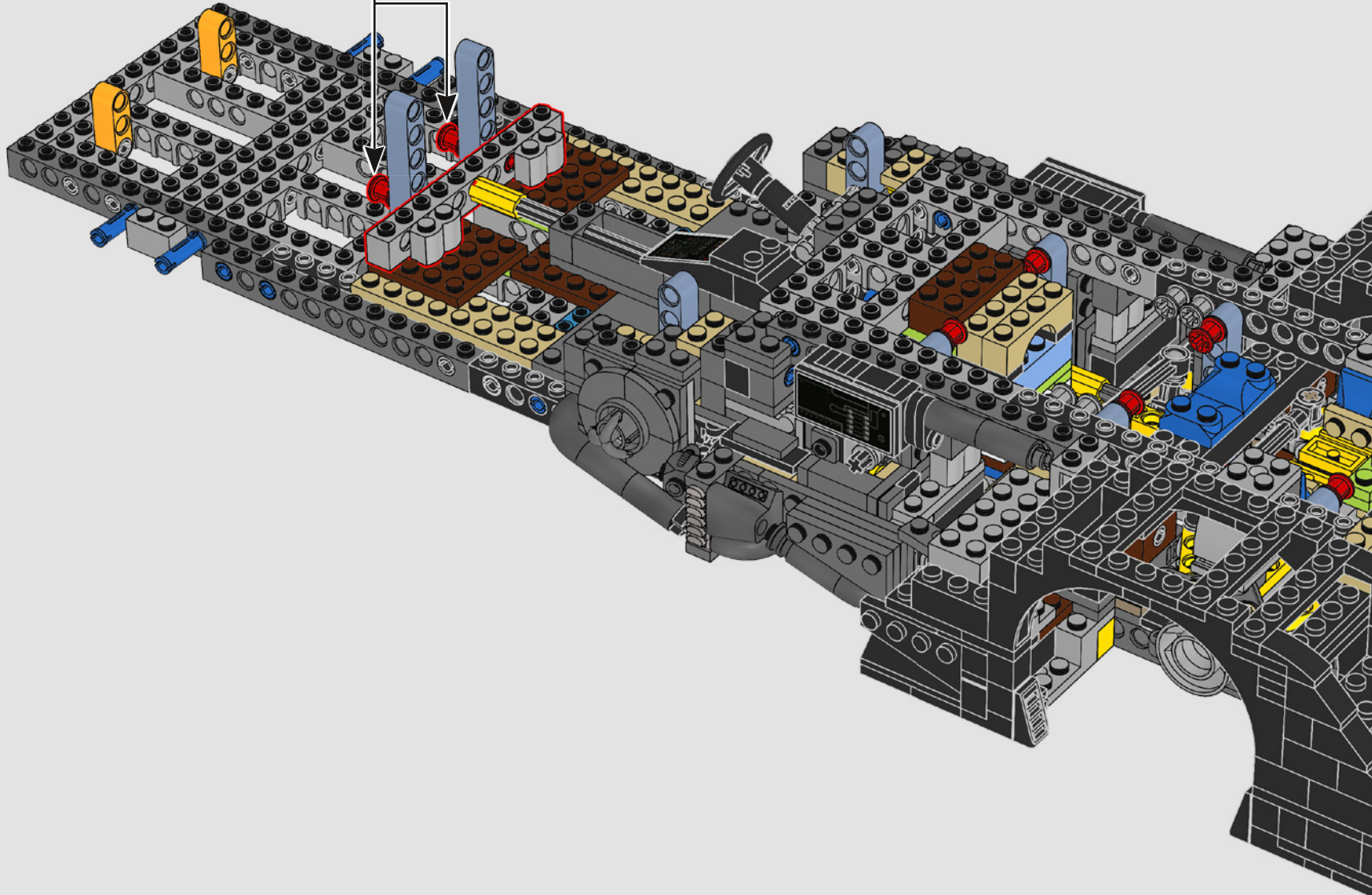

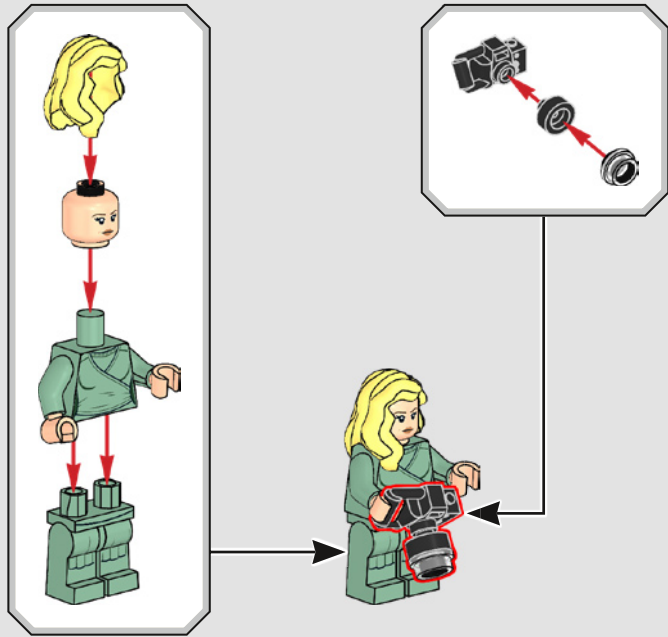
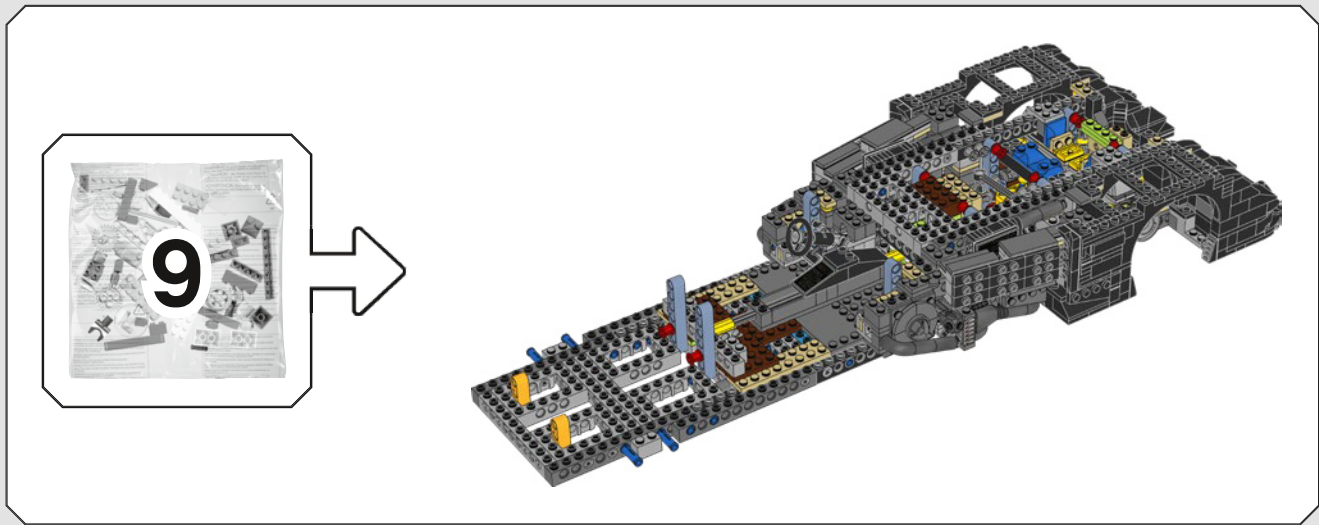



211

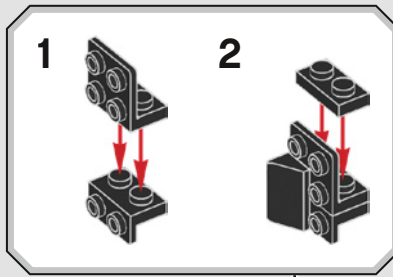

2

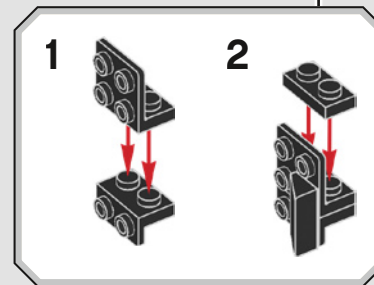
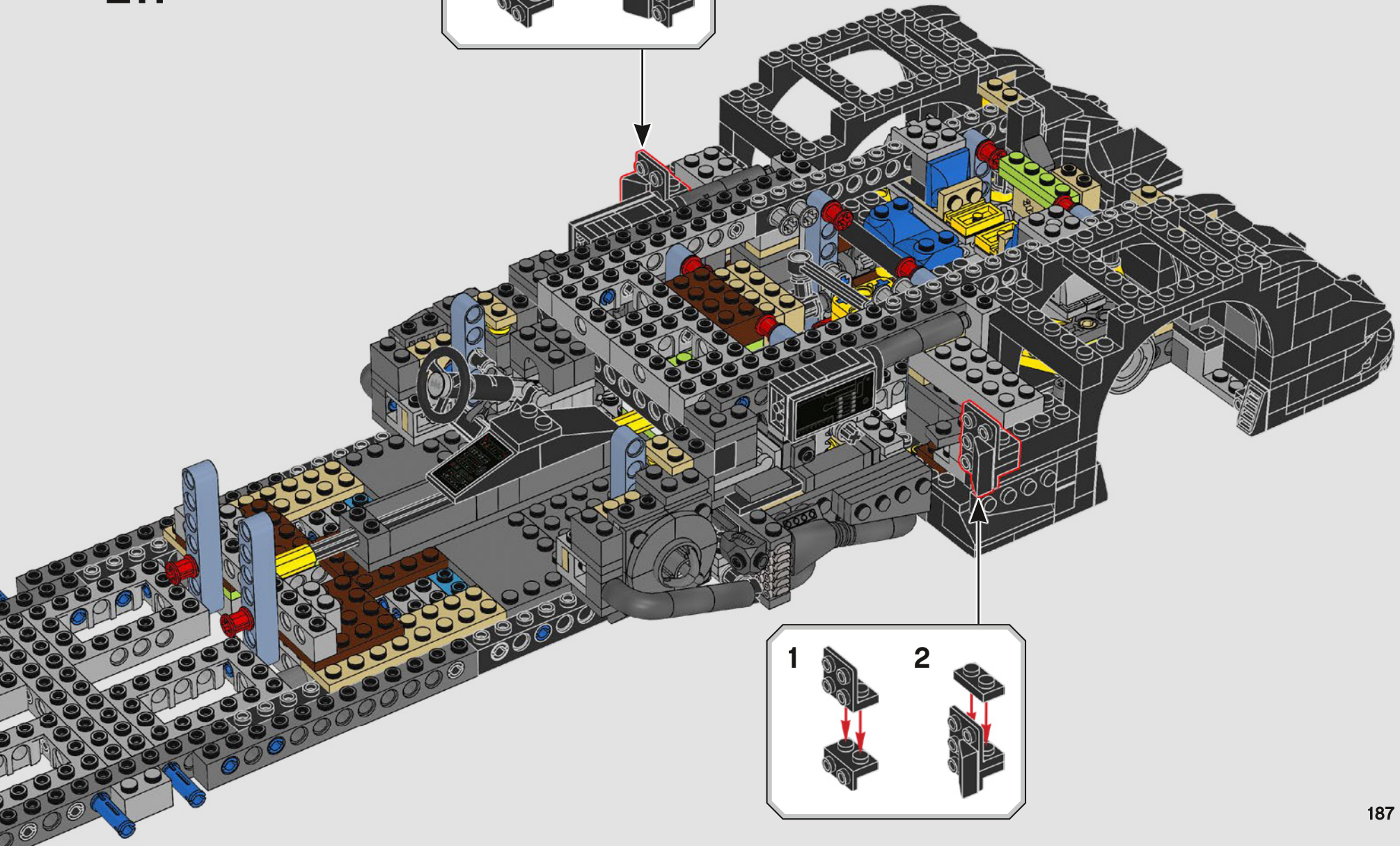

2

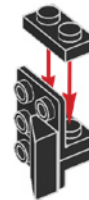



4x

212

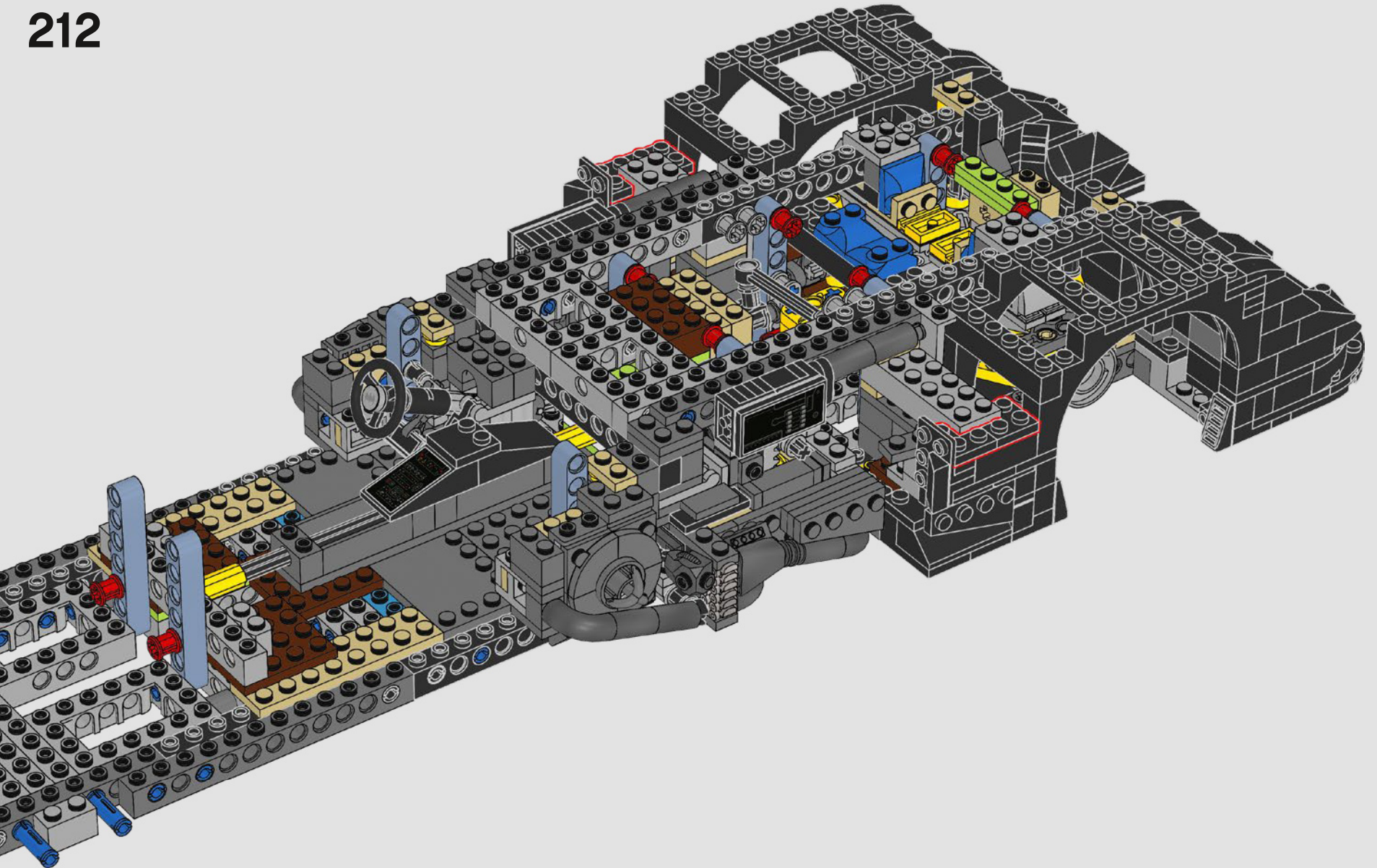

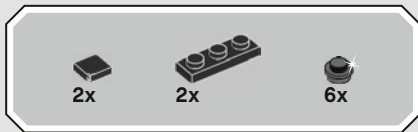

213

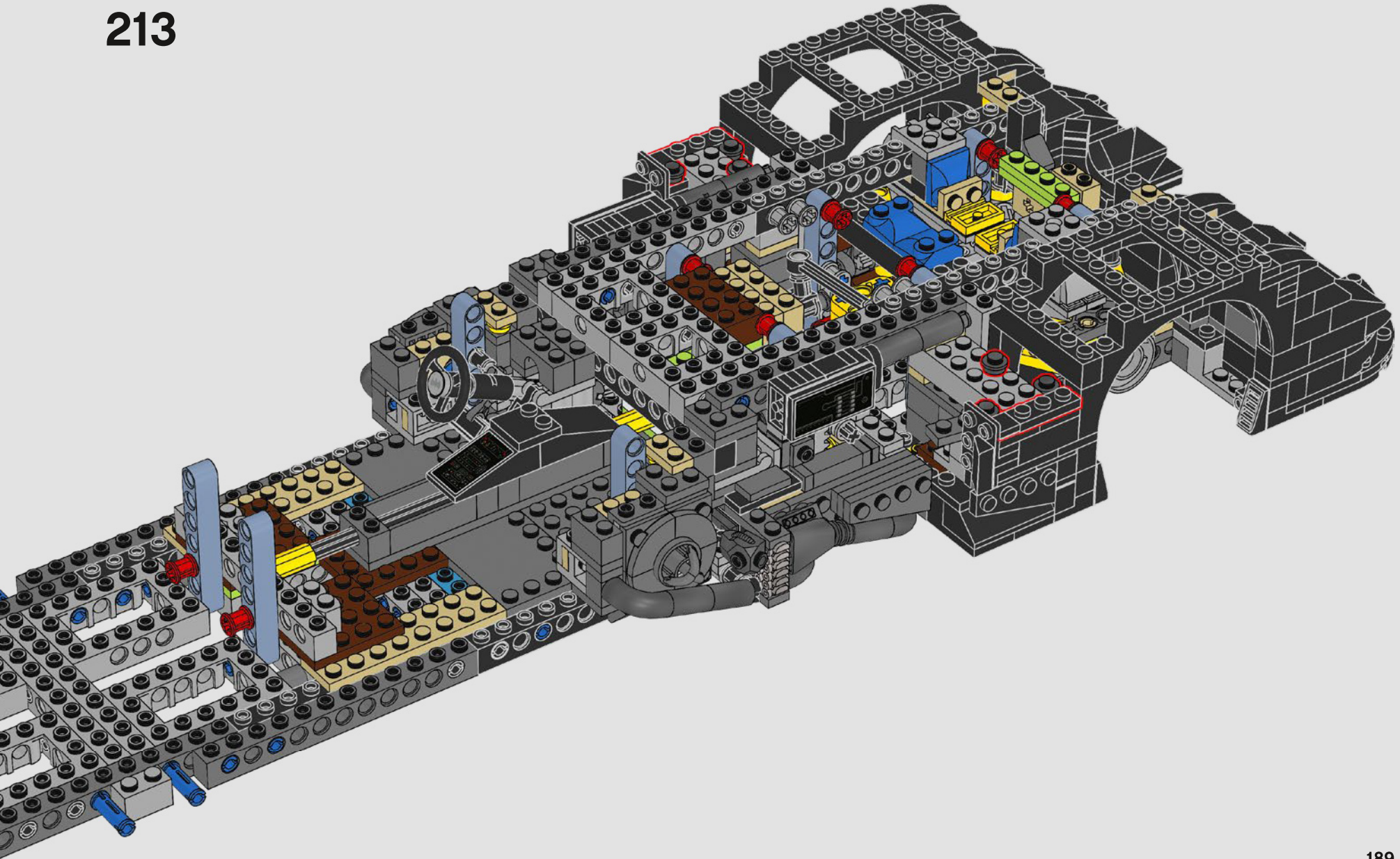

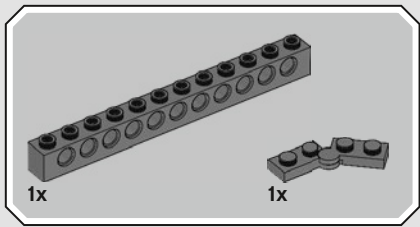

214

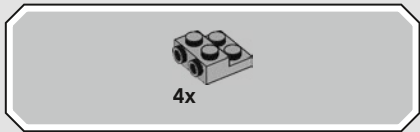
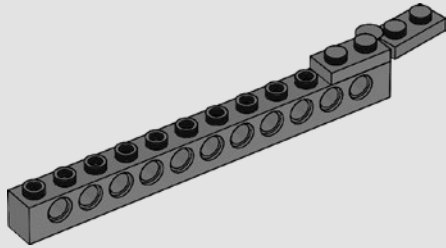

215

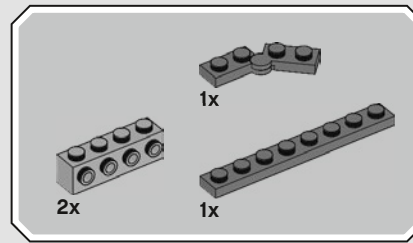
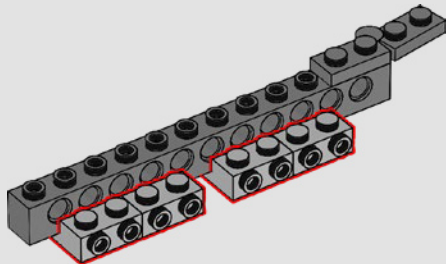

216

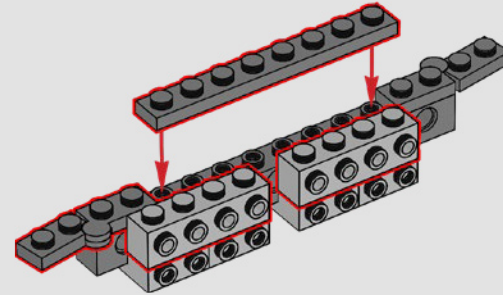

217

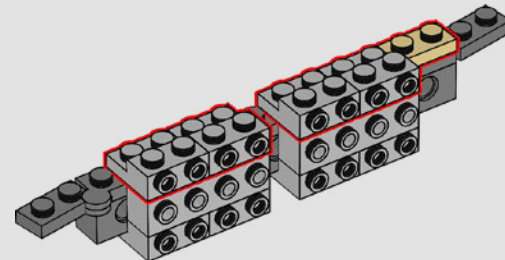

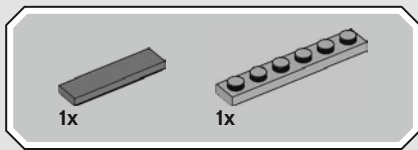

218

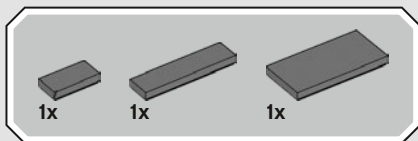
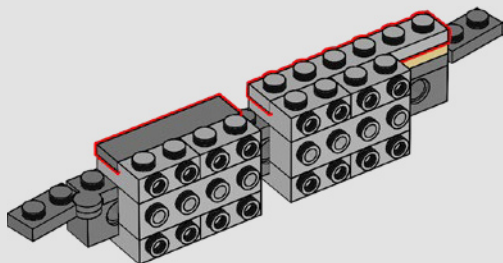

219

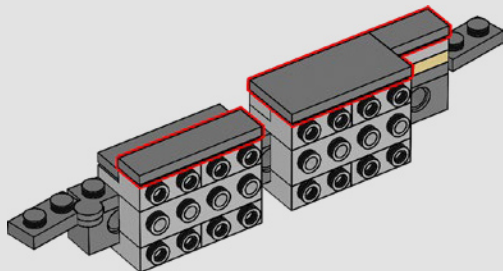

220

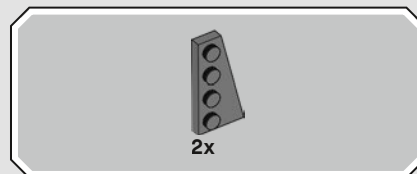
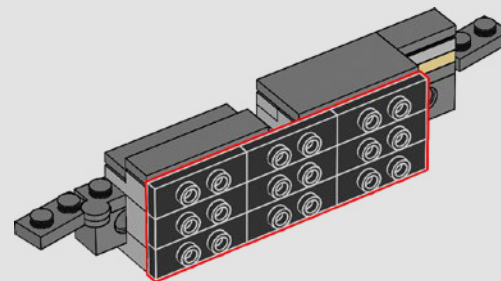

221

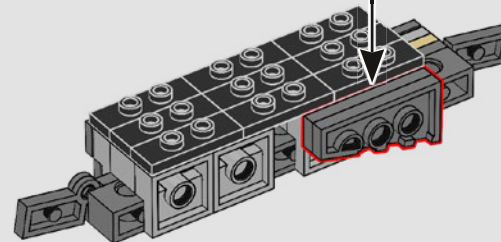
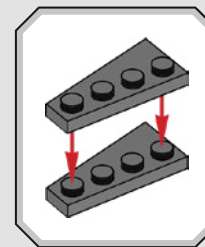

222

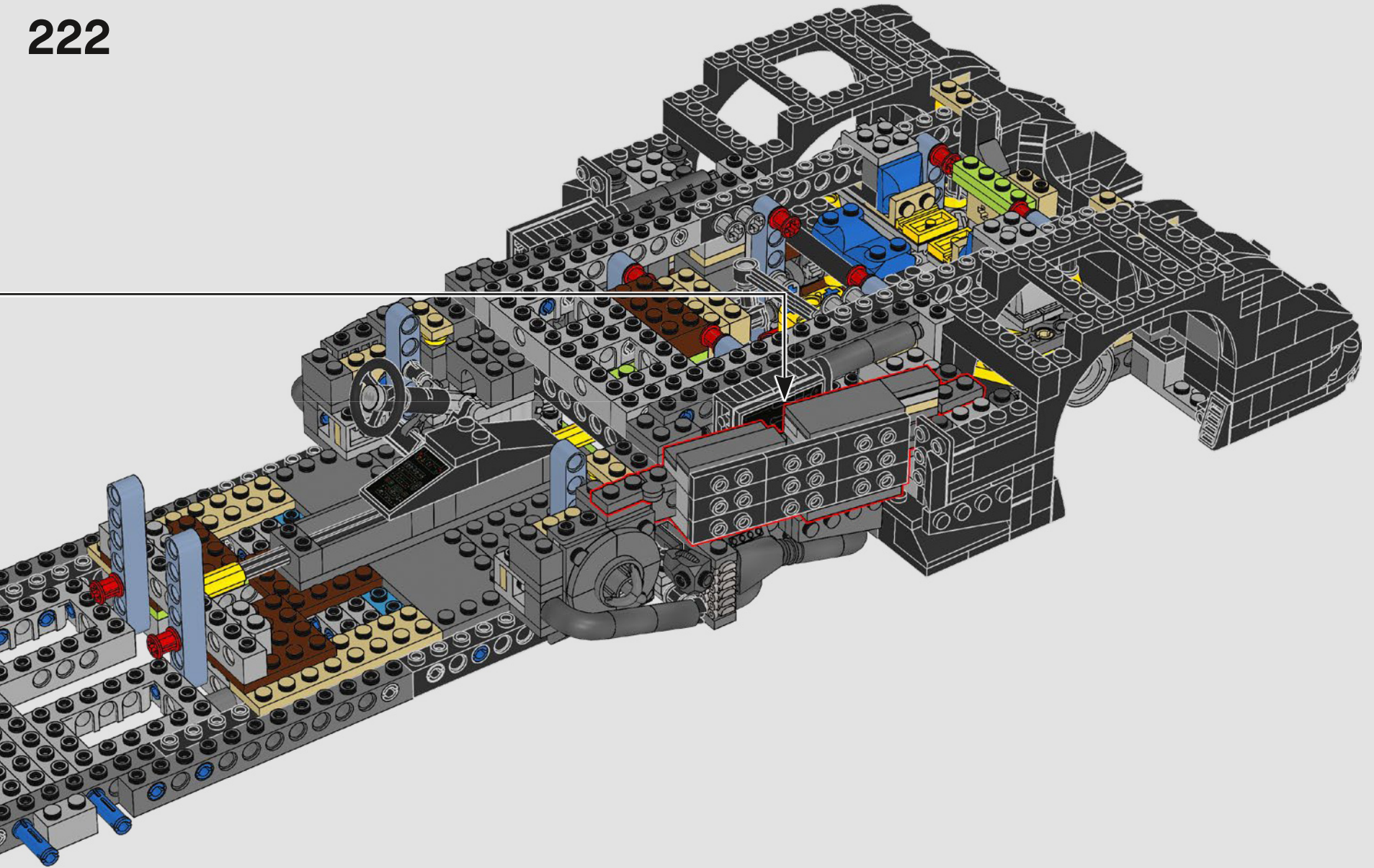



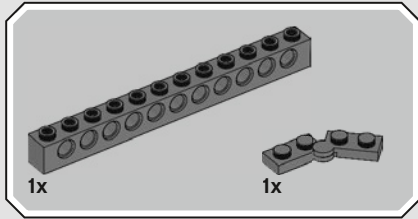
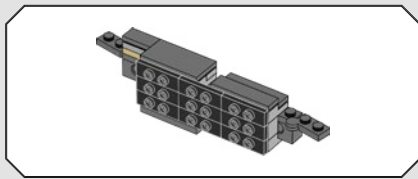

223

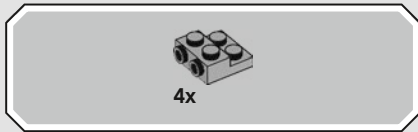
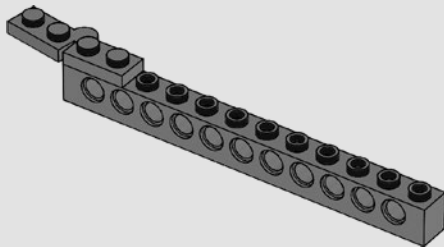

224

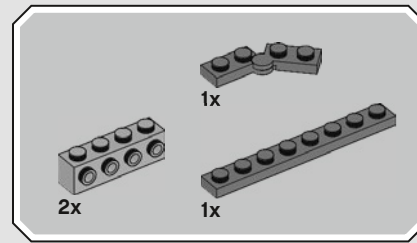
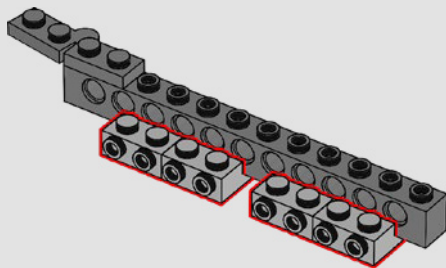

225

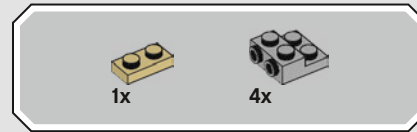
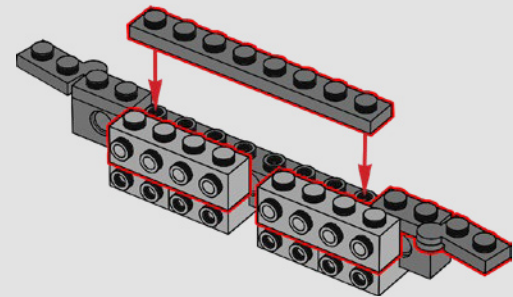

226

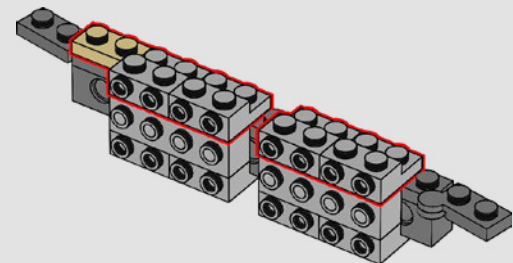

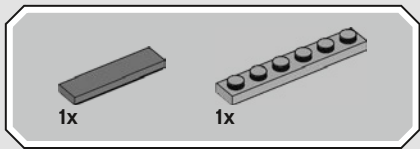

227

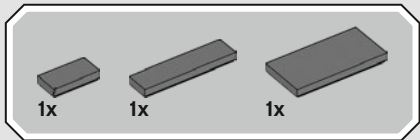
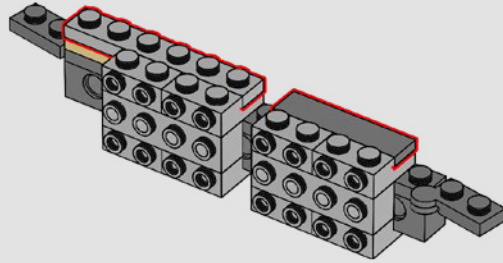

228

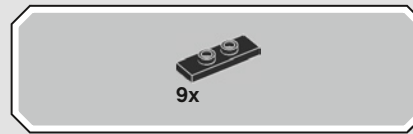
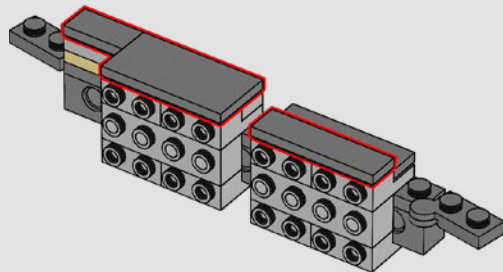

229

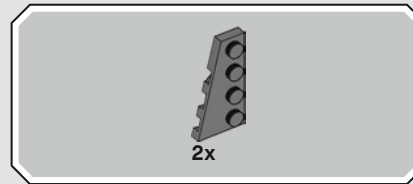
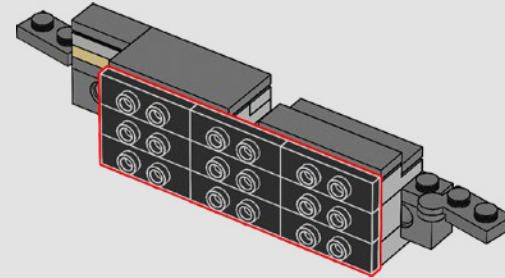

230

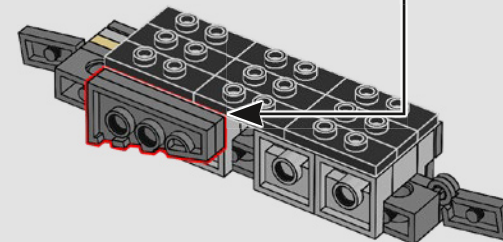
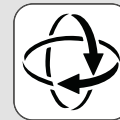
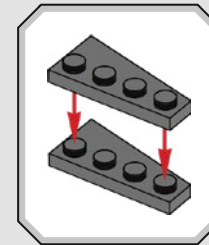

231

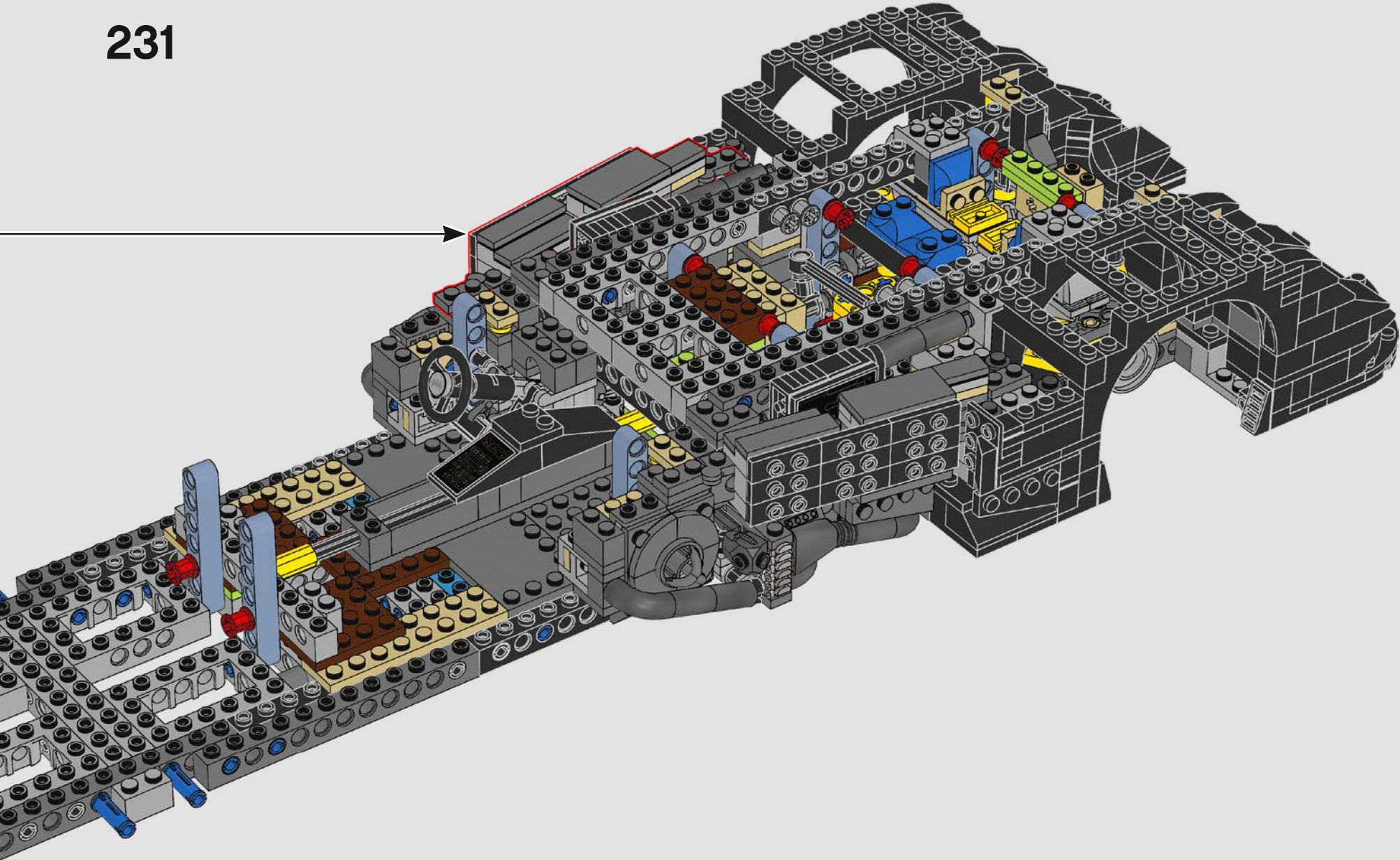

2x 6x 2x

232

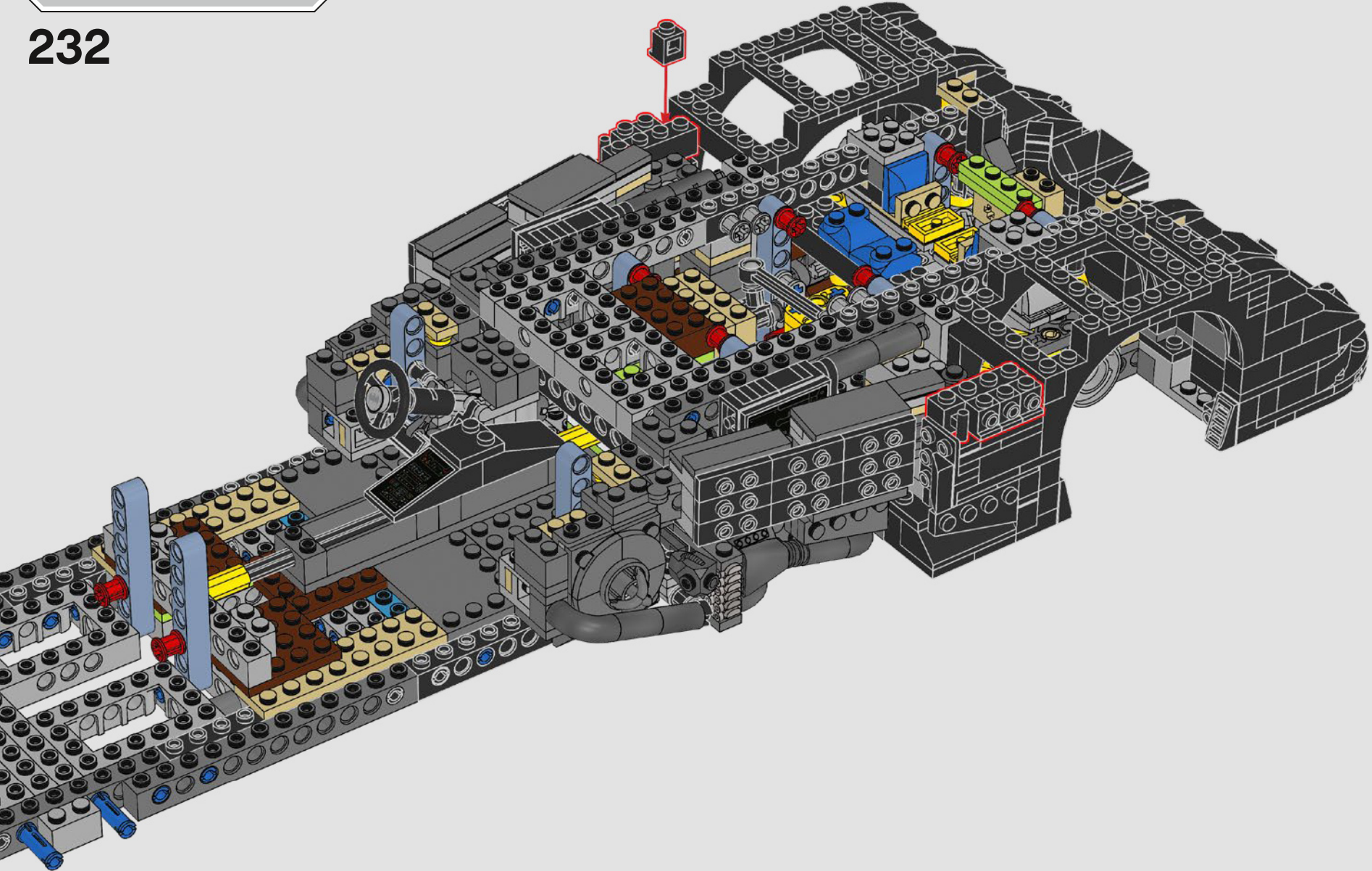

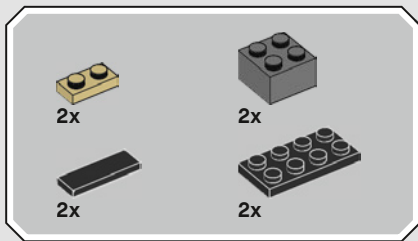

233

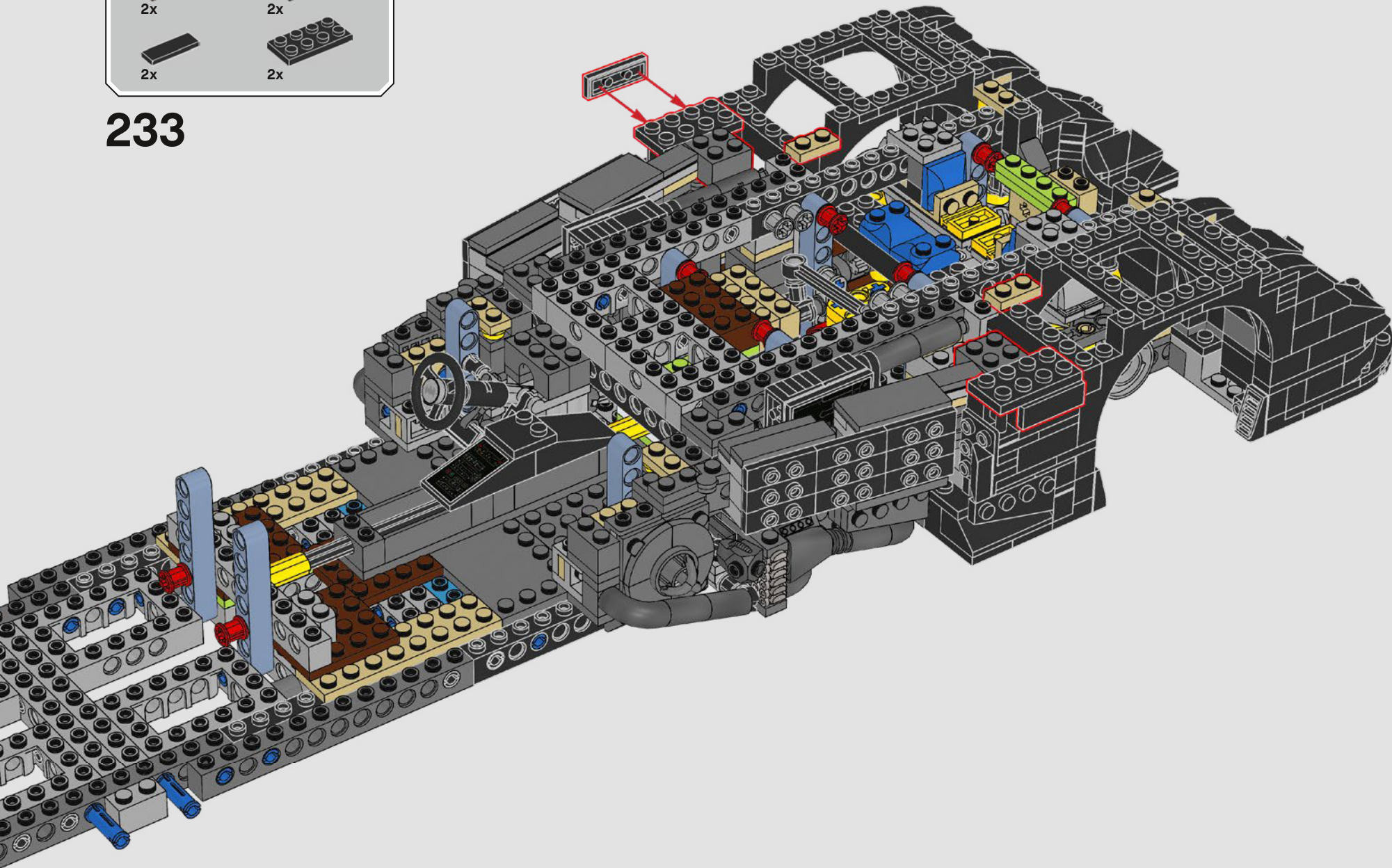

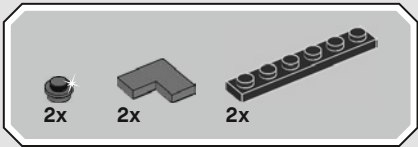

234

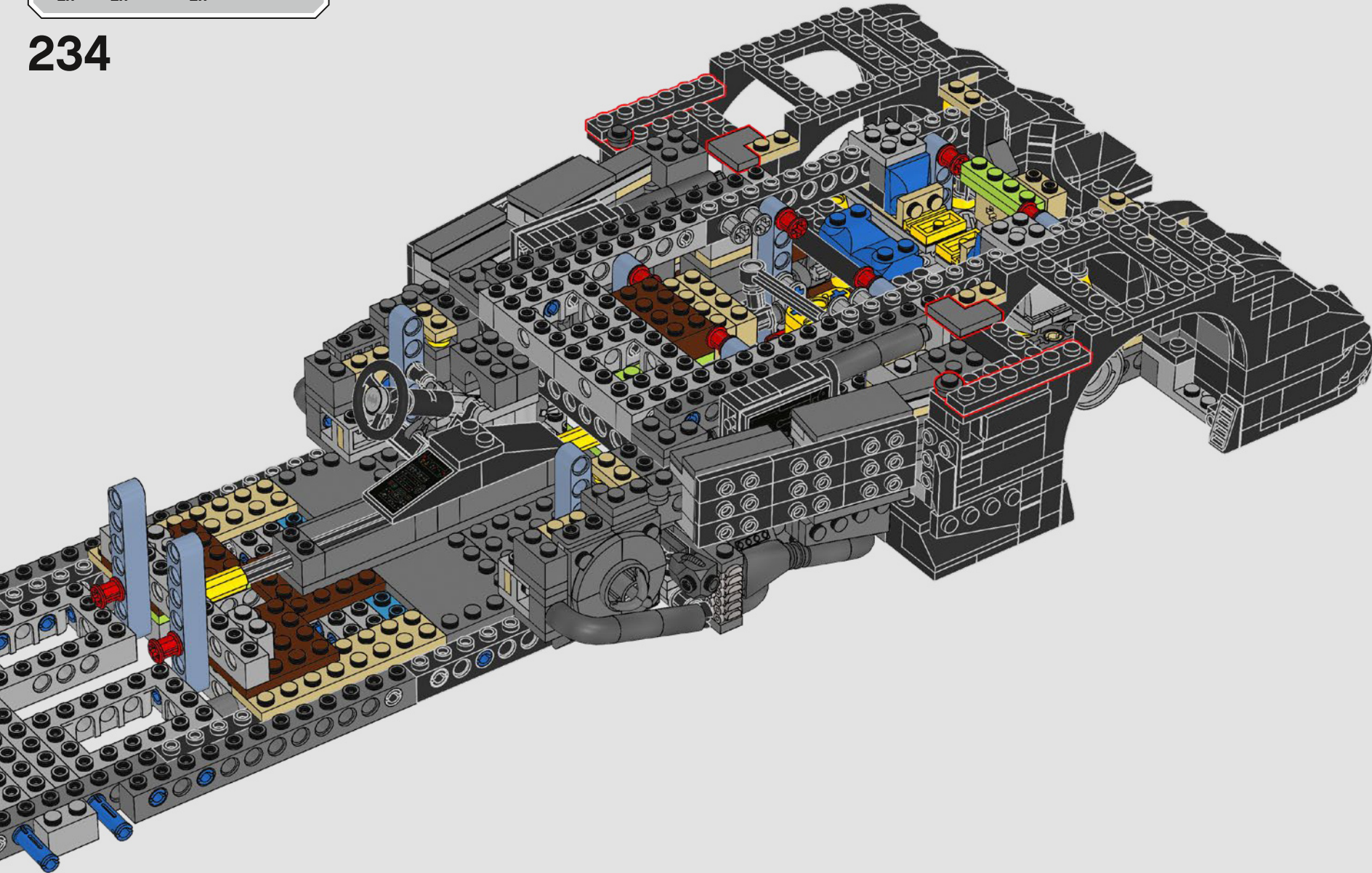

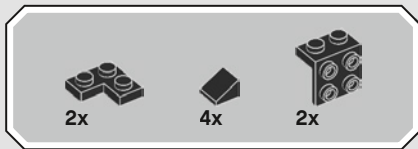

235

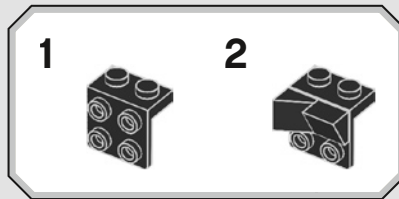

2

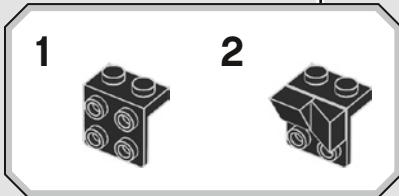
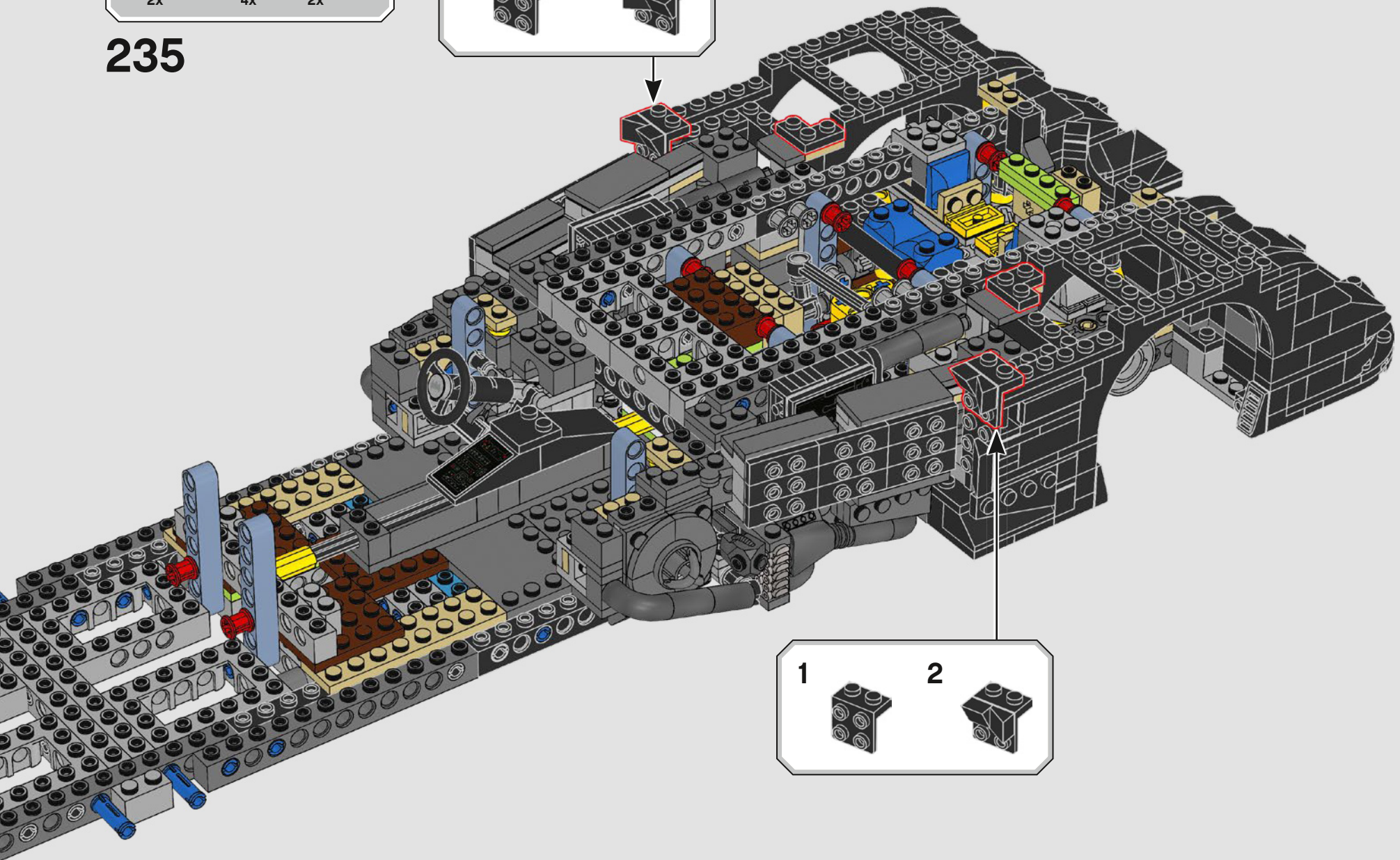

2

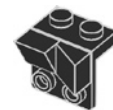



2x

236

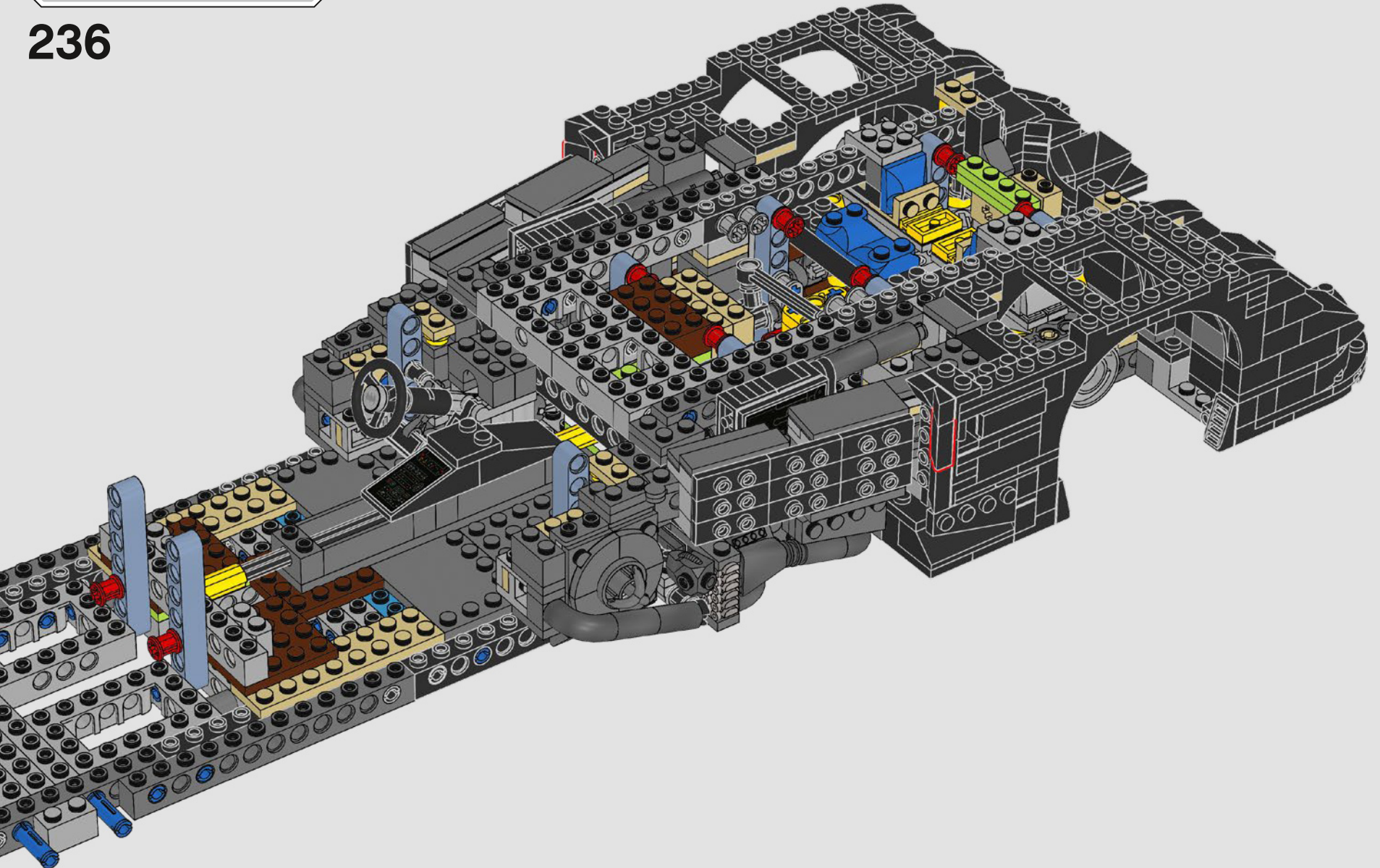



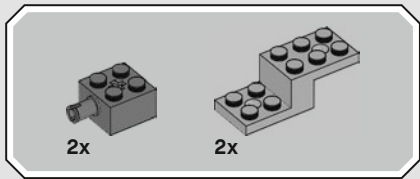
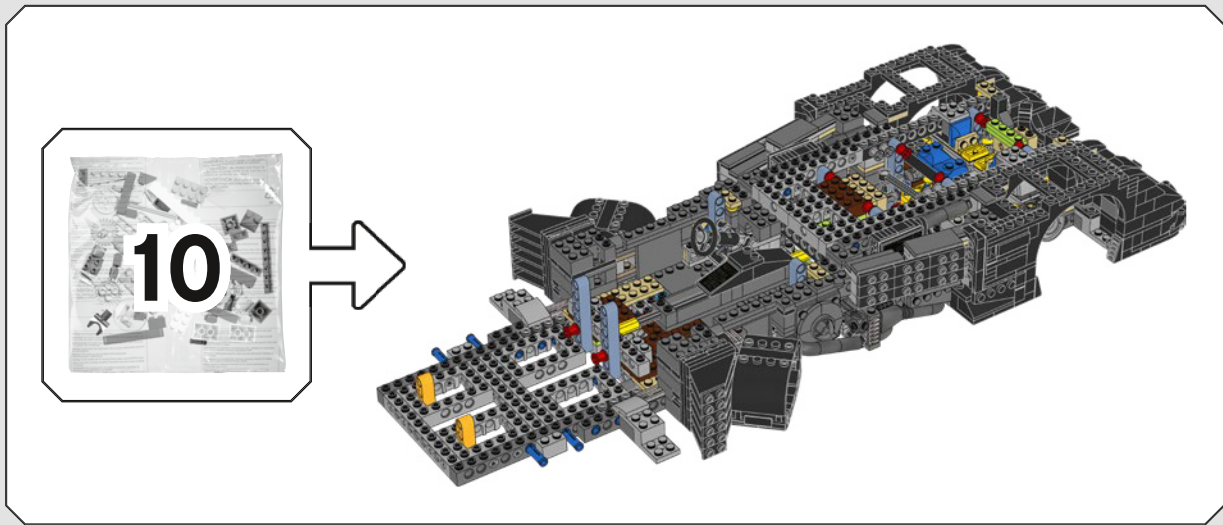

237

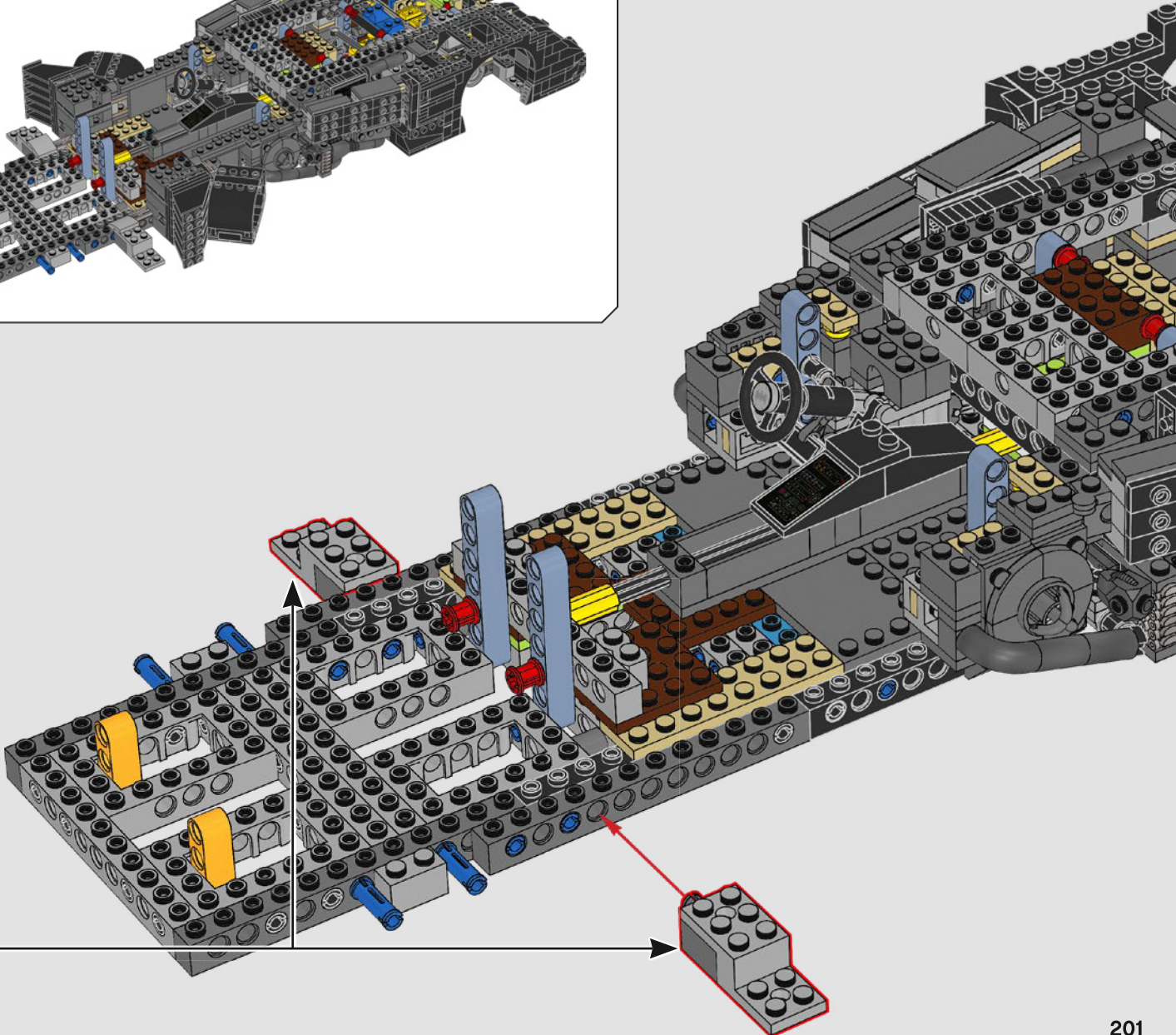
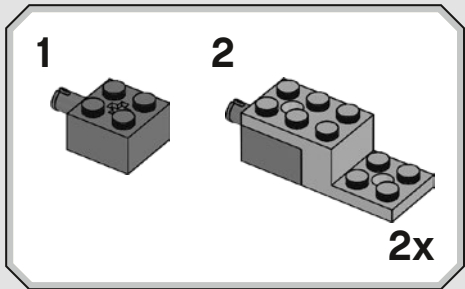

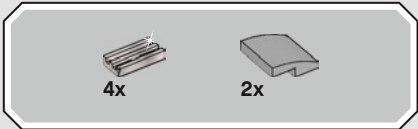

238

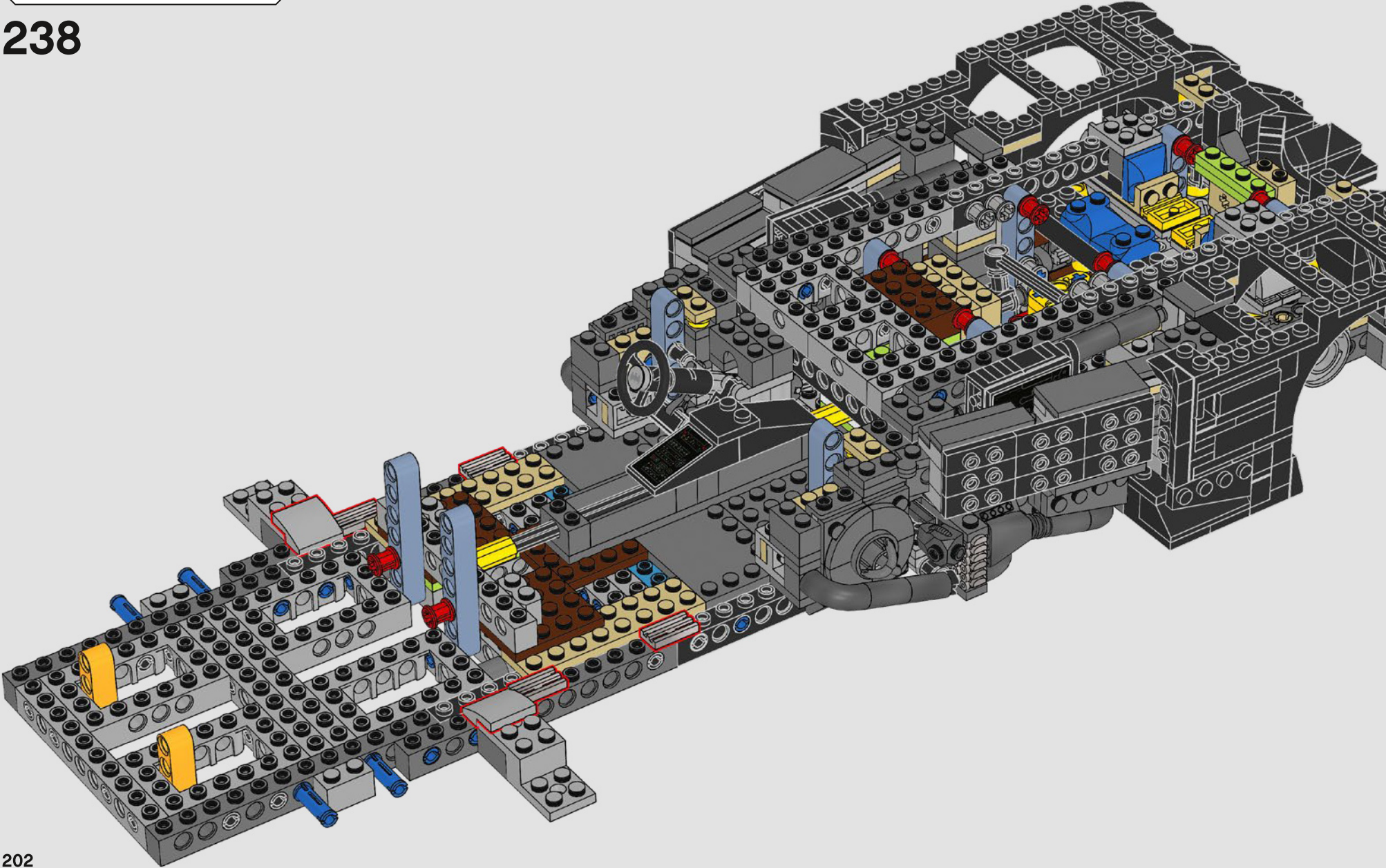

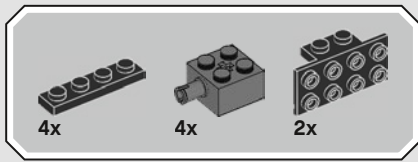

239

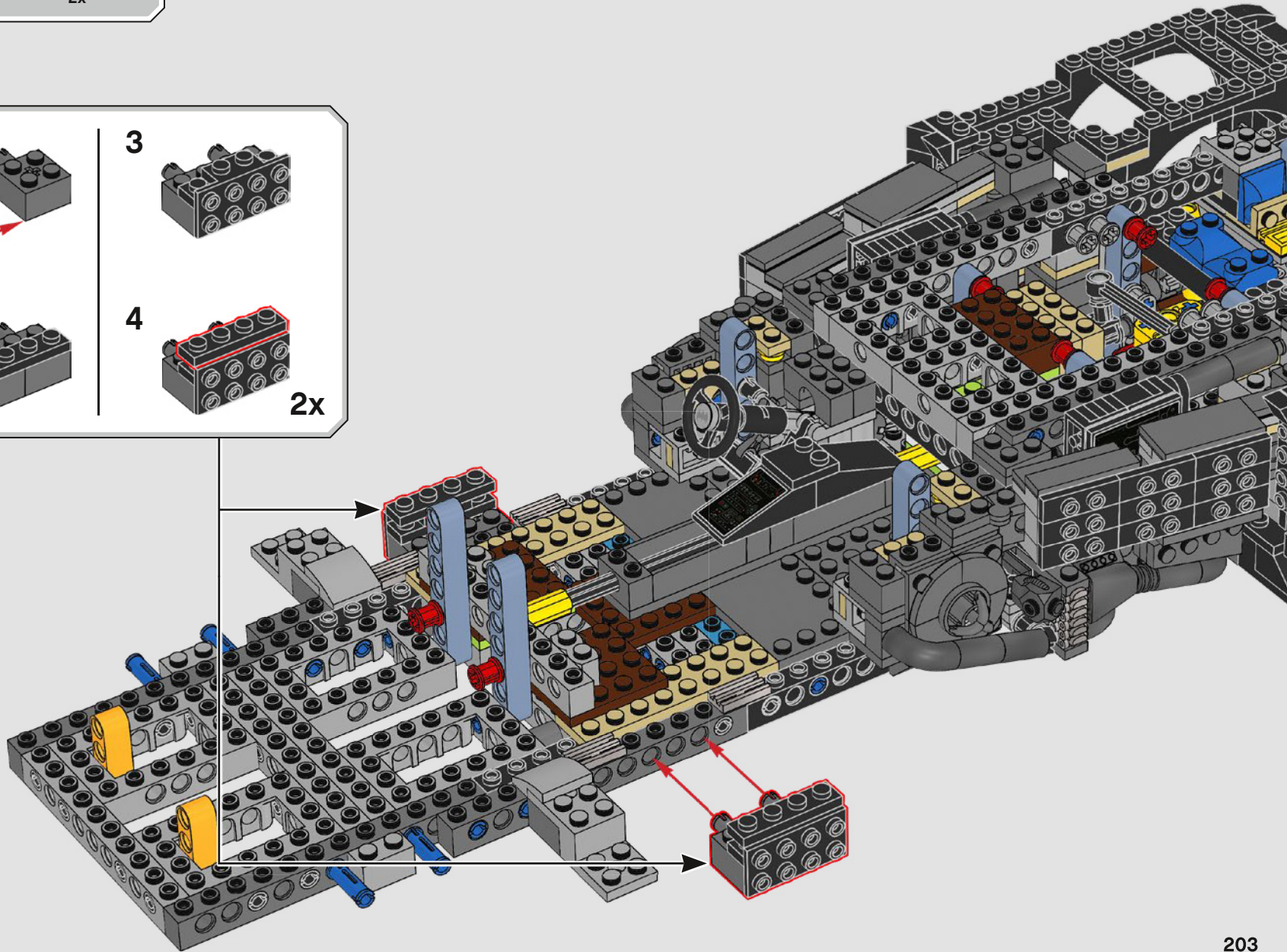
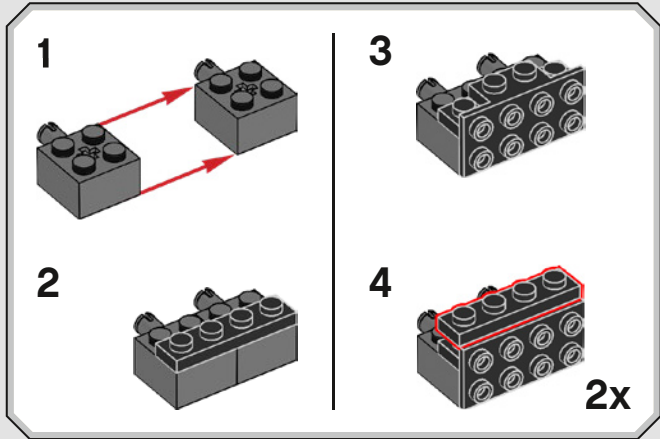

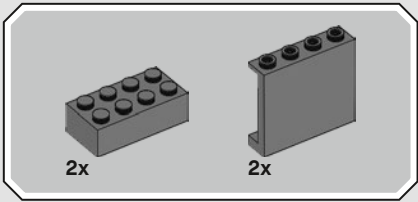

240

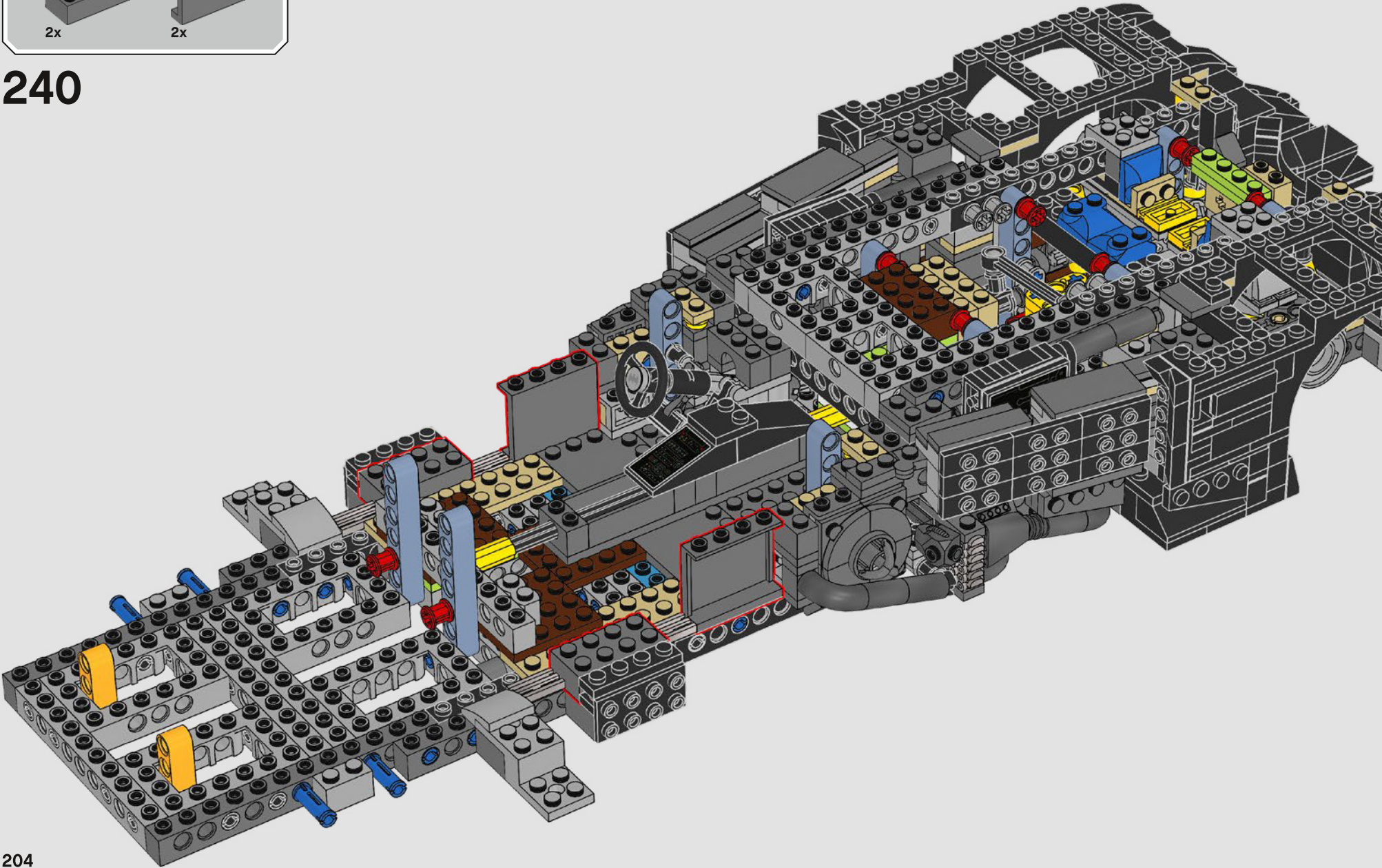

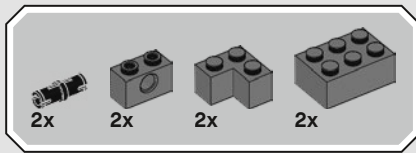

241

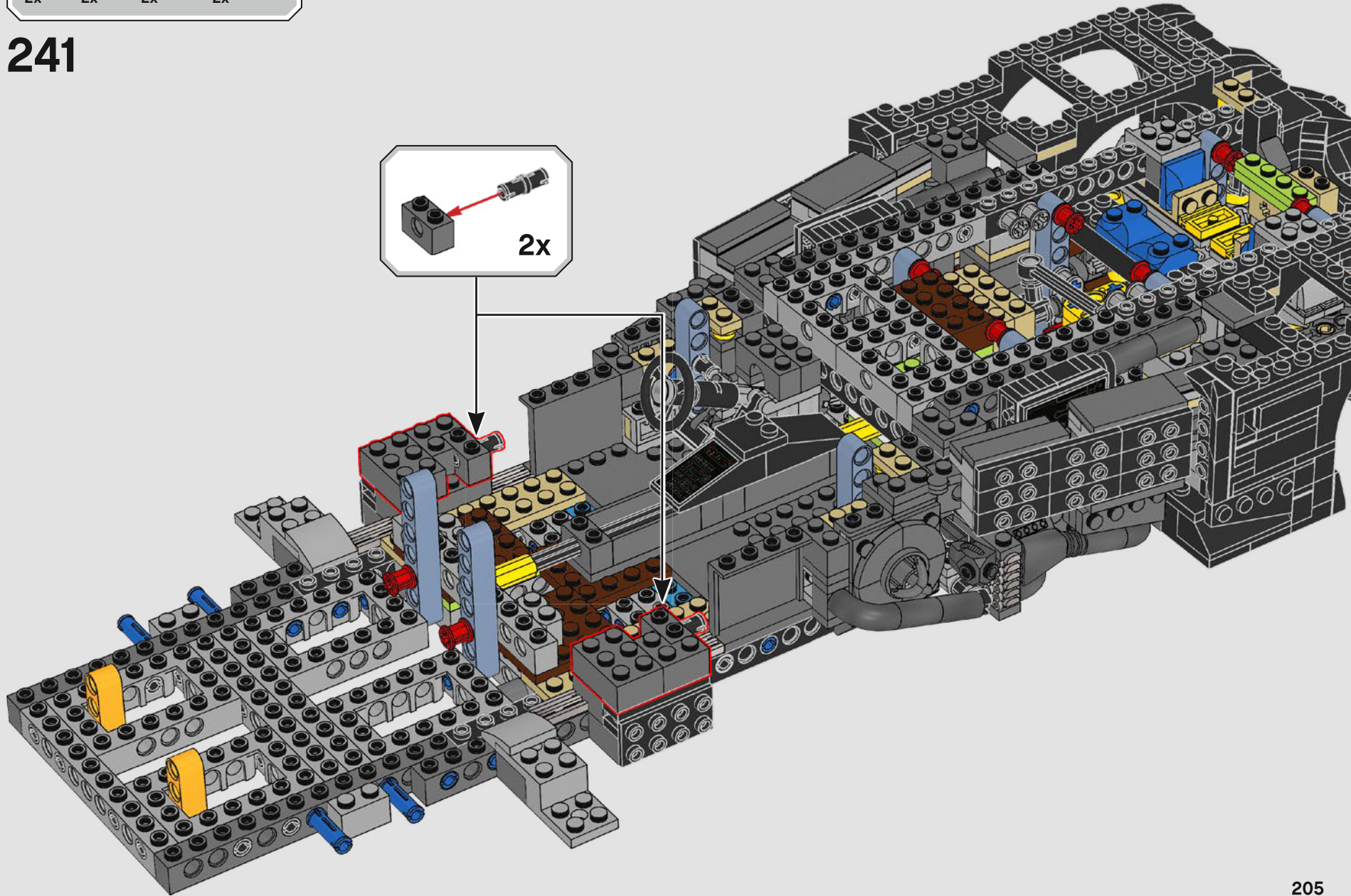
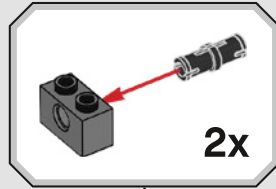

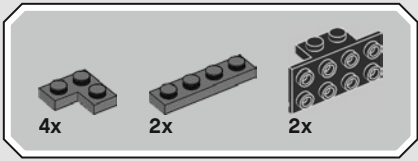

# 242

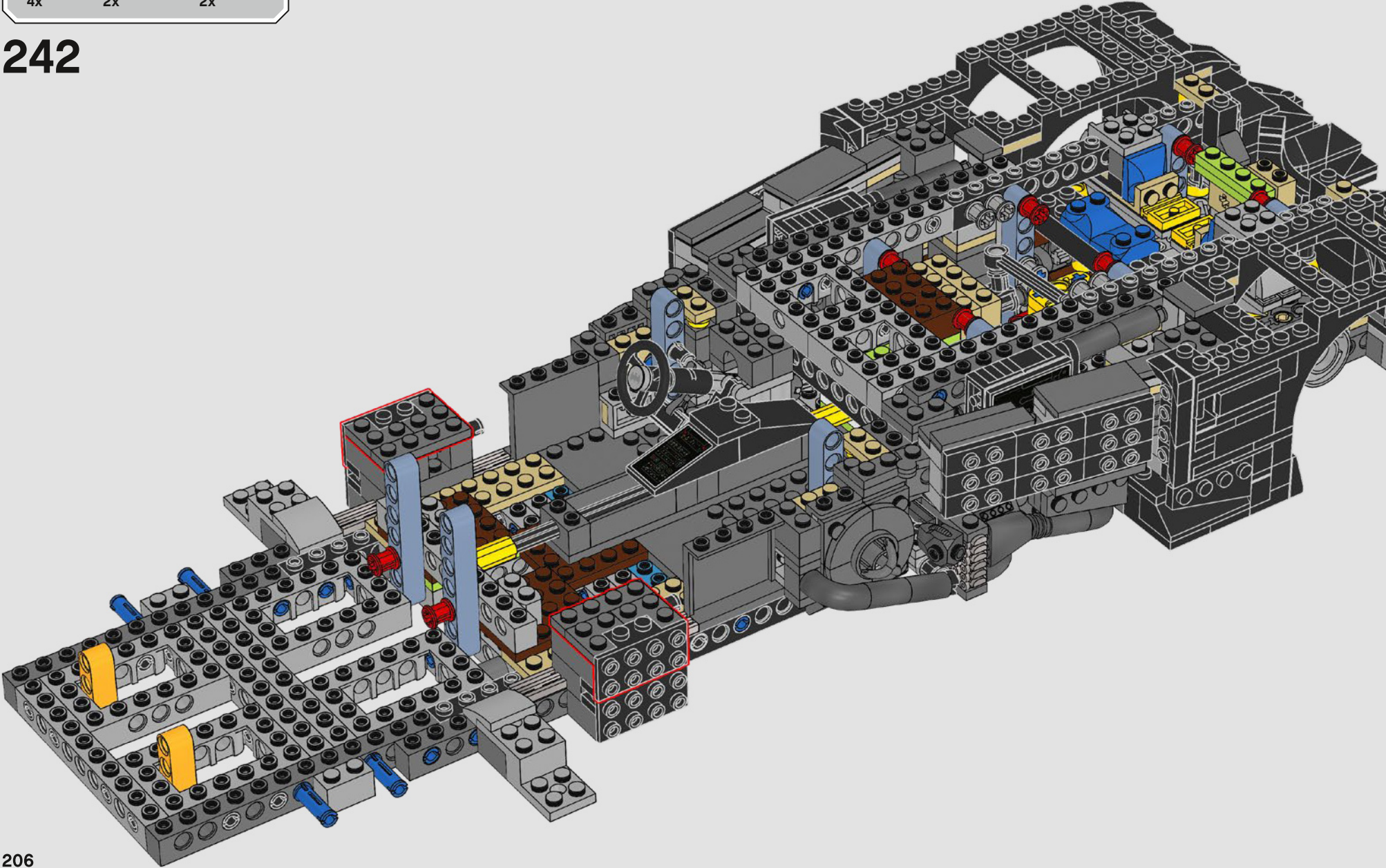

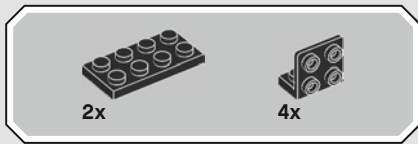

243

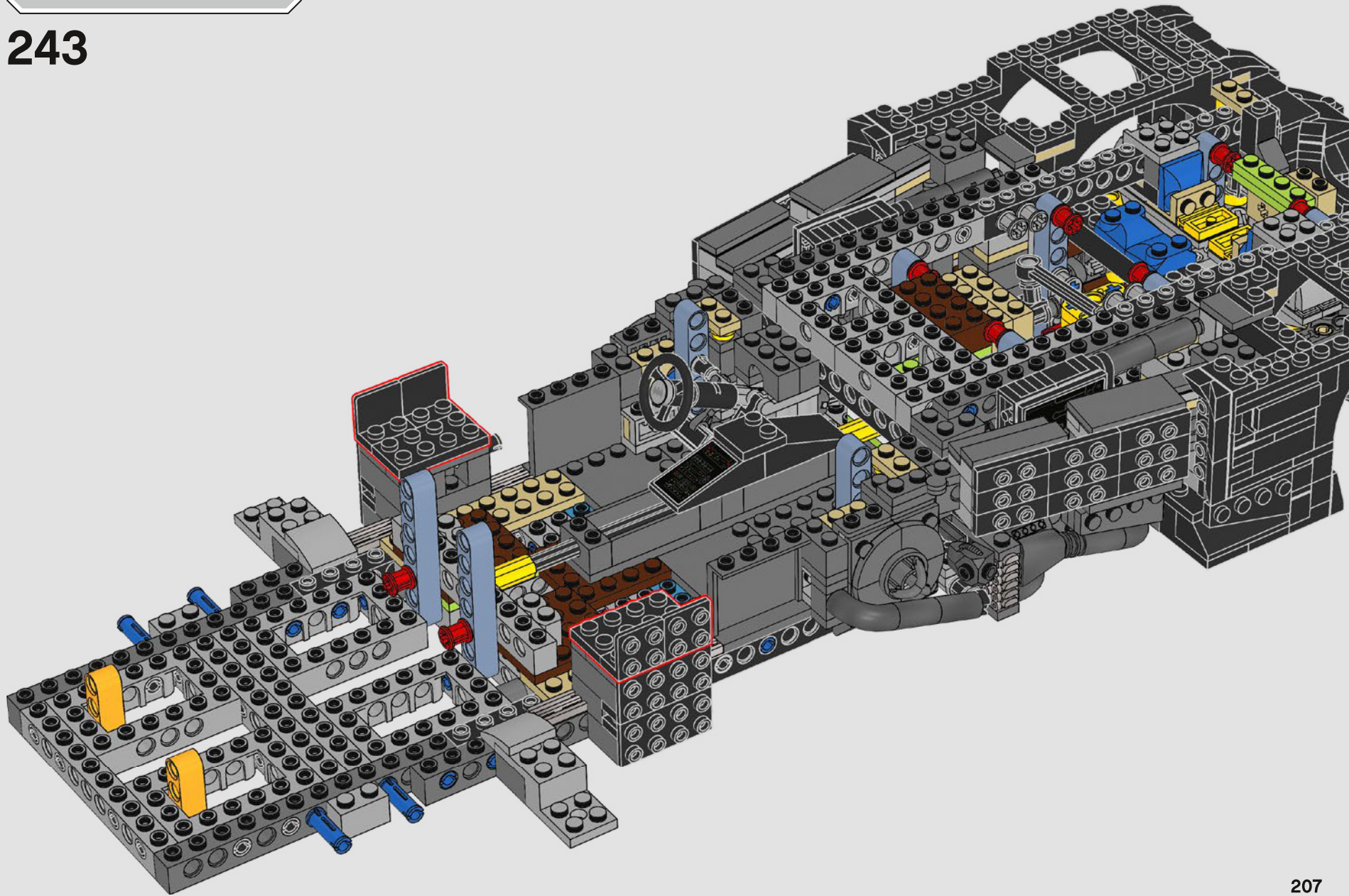

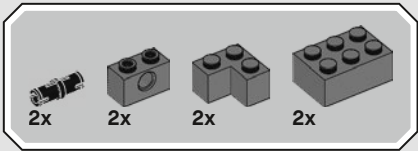

# 244

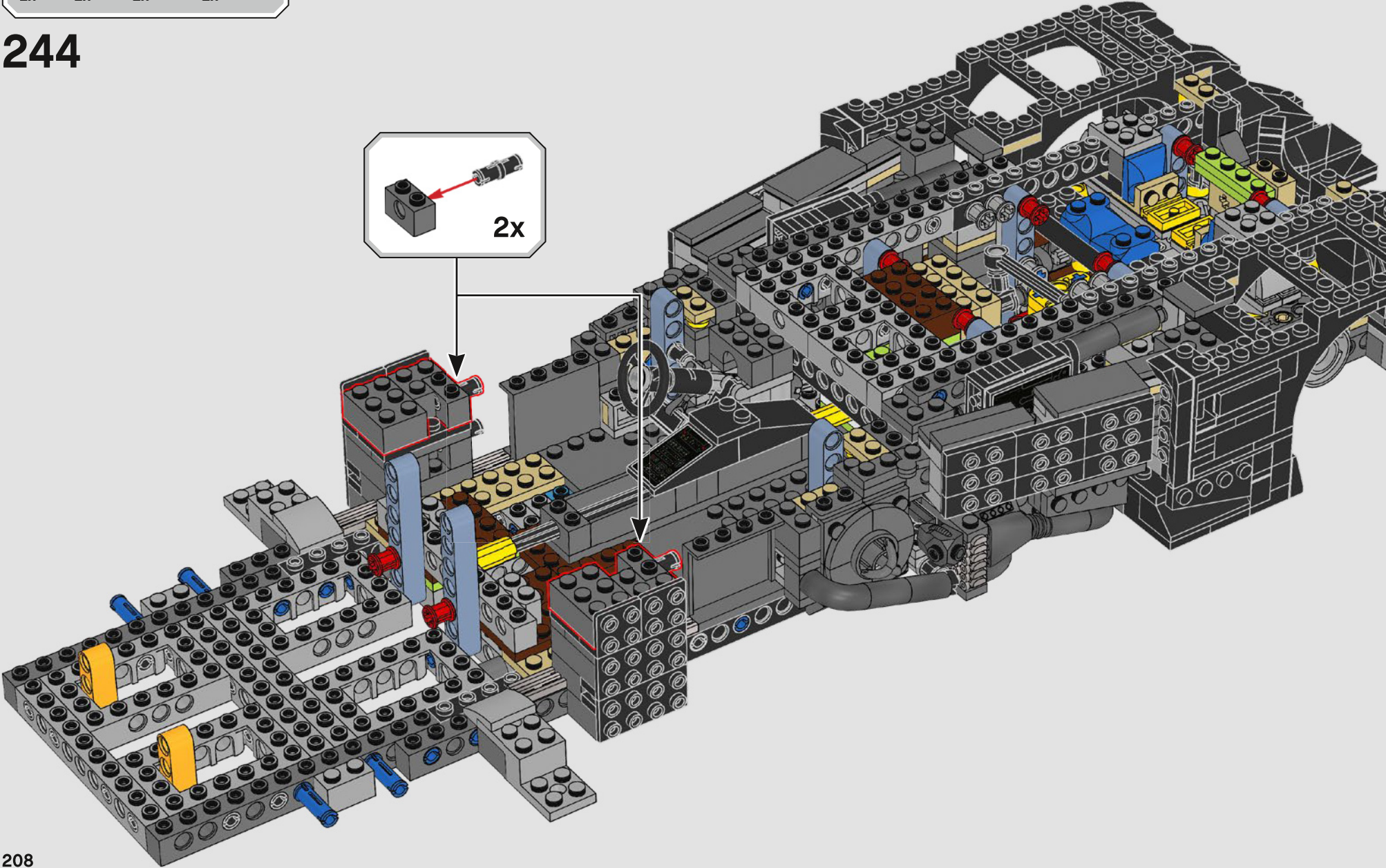
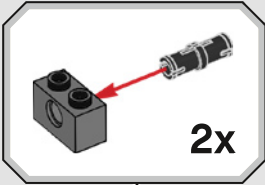



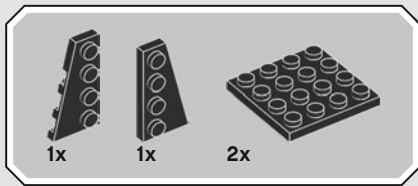

245

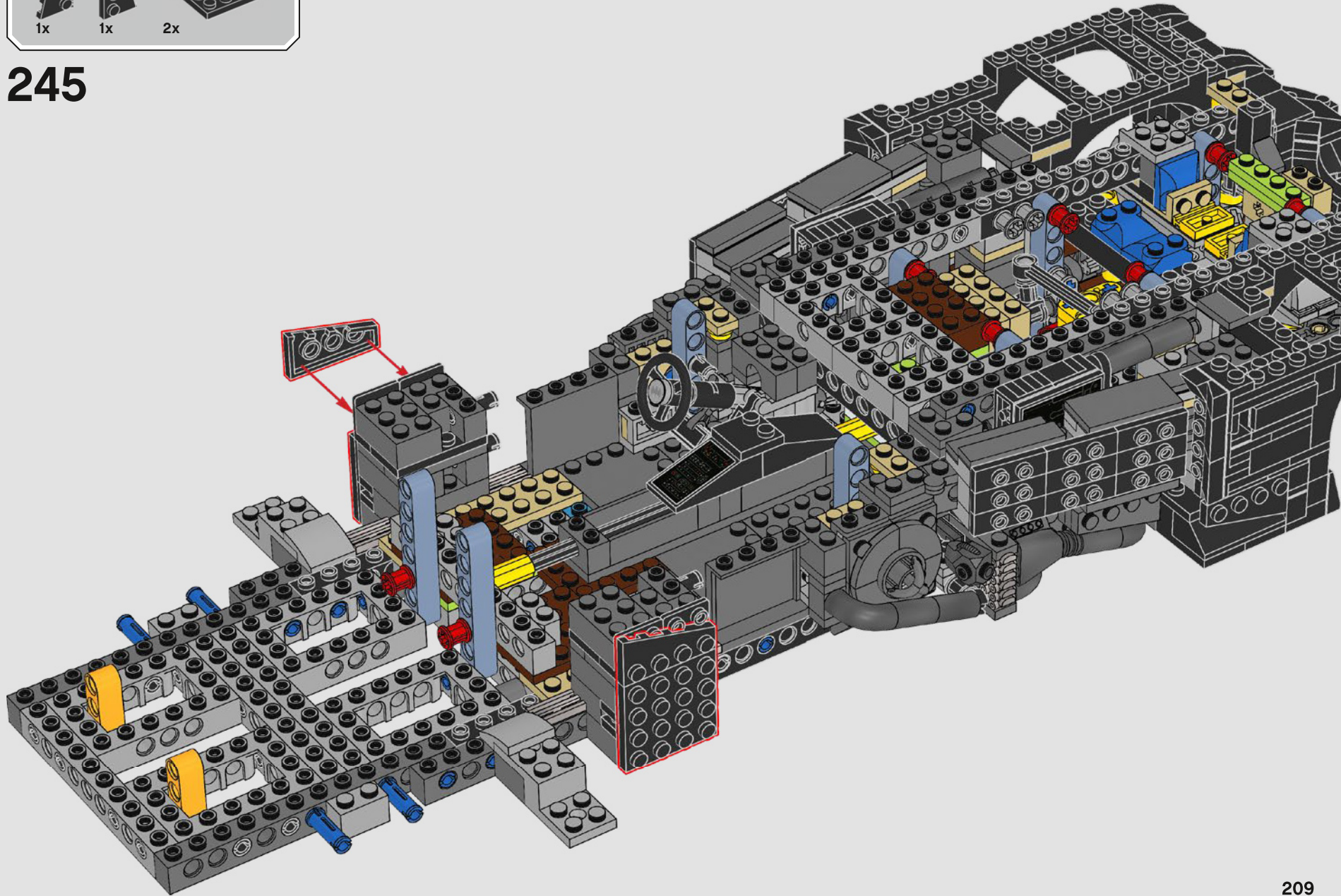

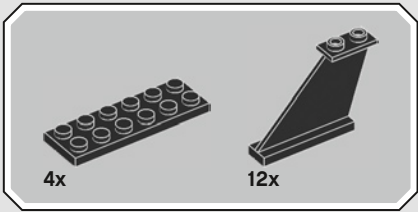

# 246

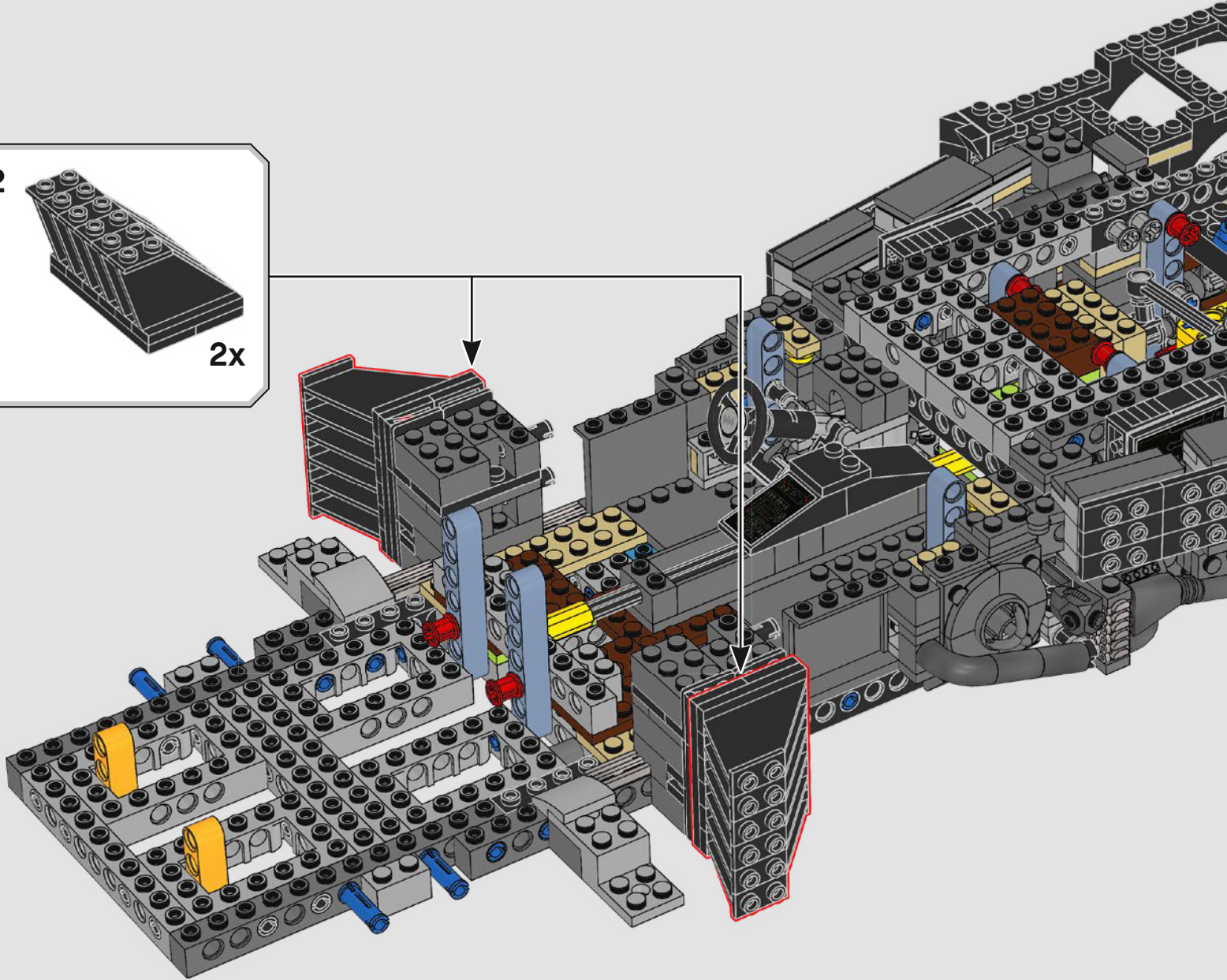
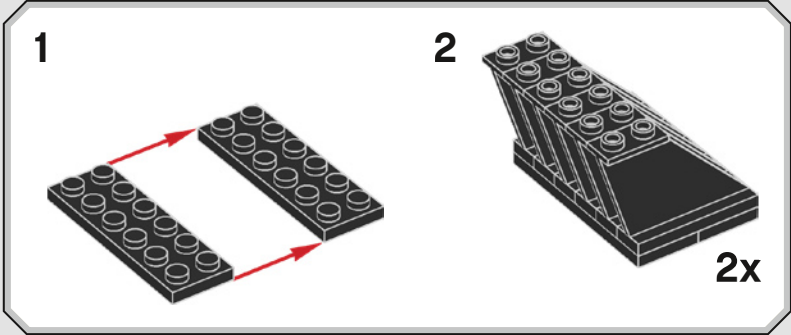

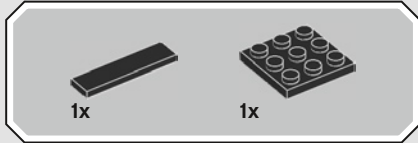
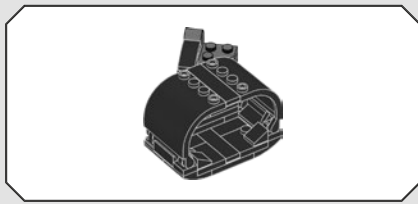

247

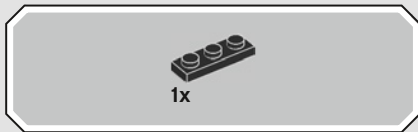
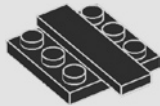

248

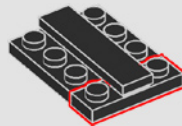

249

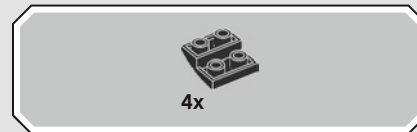
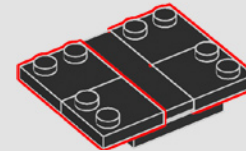

250

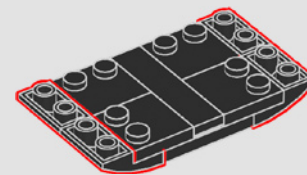

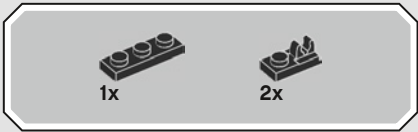

251

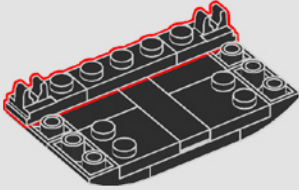

252

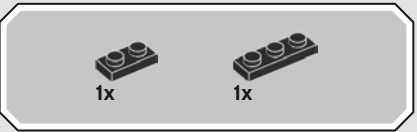
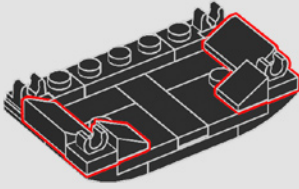

253

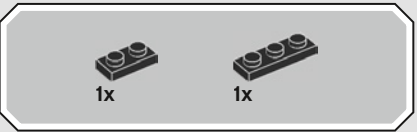
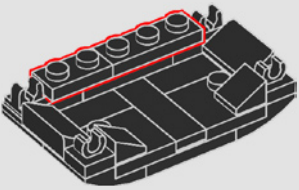

254

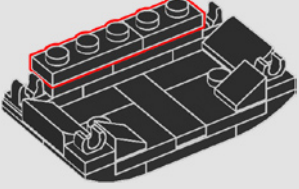

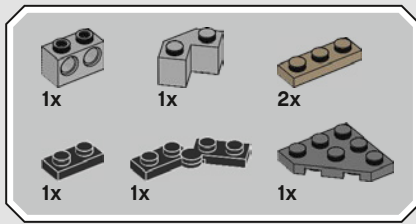

255

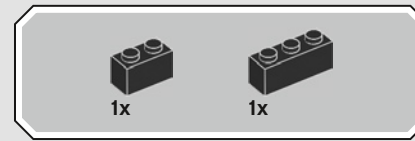
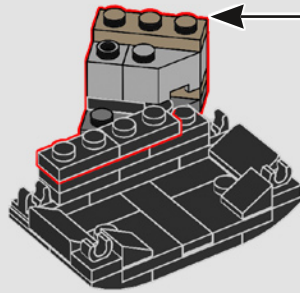
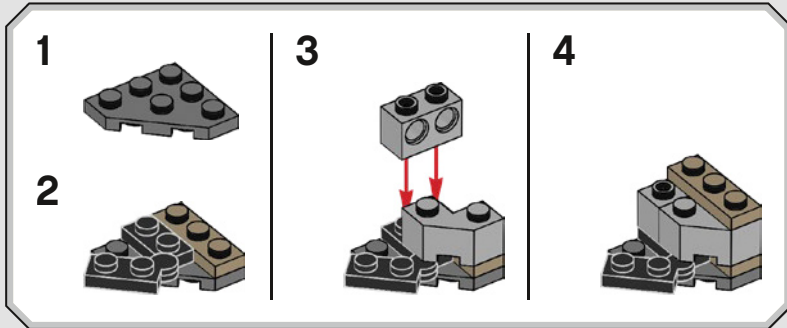

256

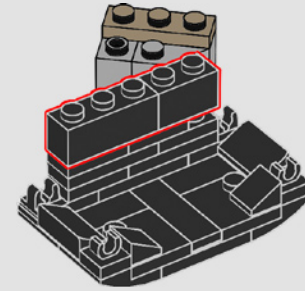

257

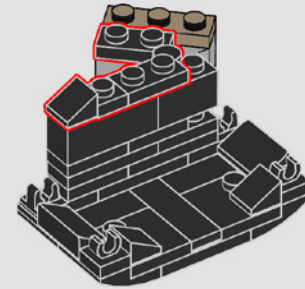

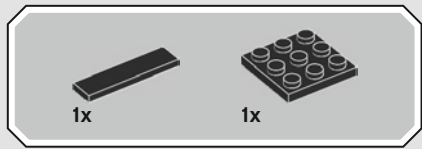

258

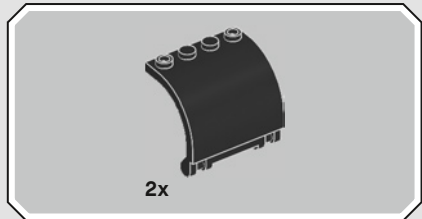
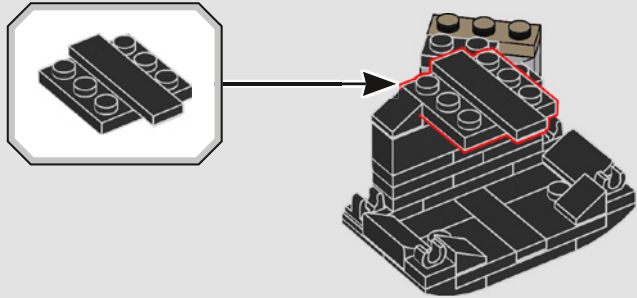

259

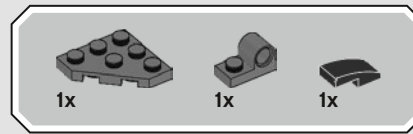
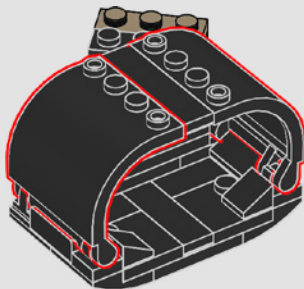

260

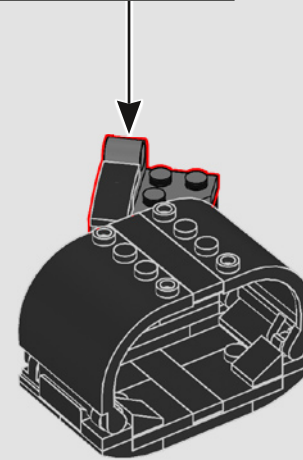
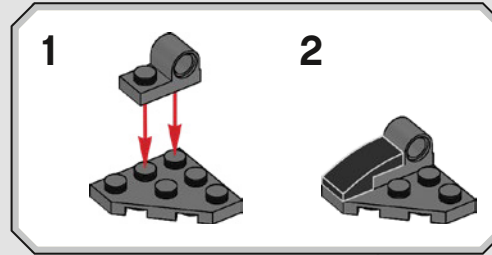

261

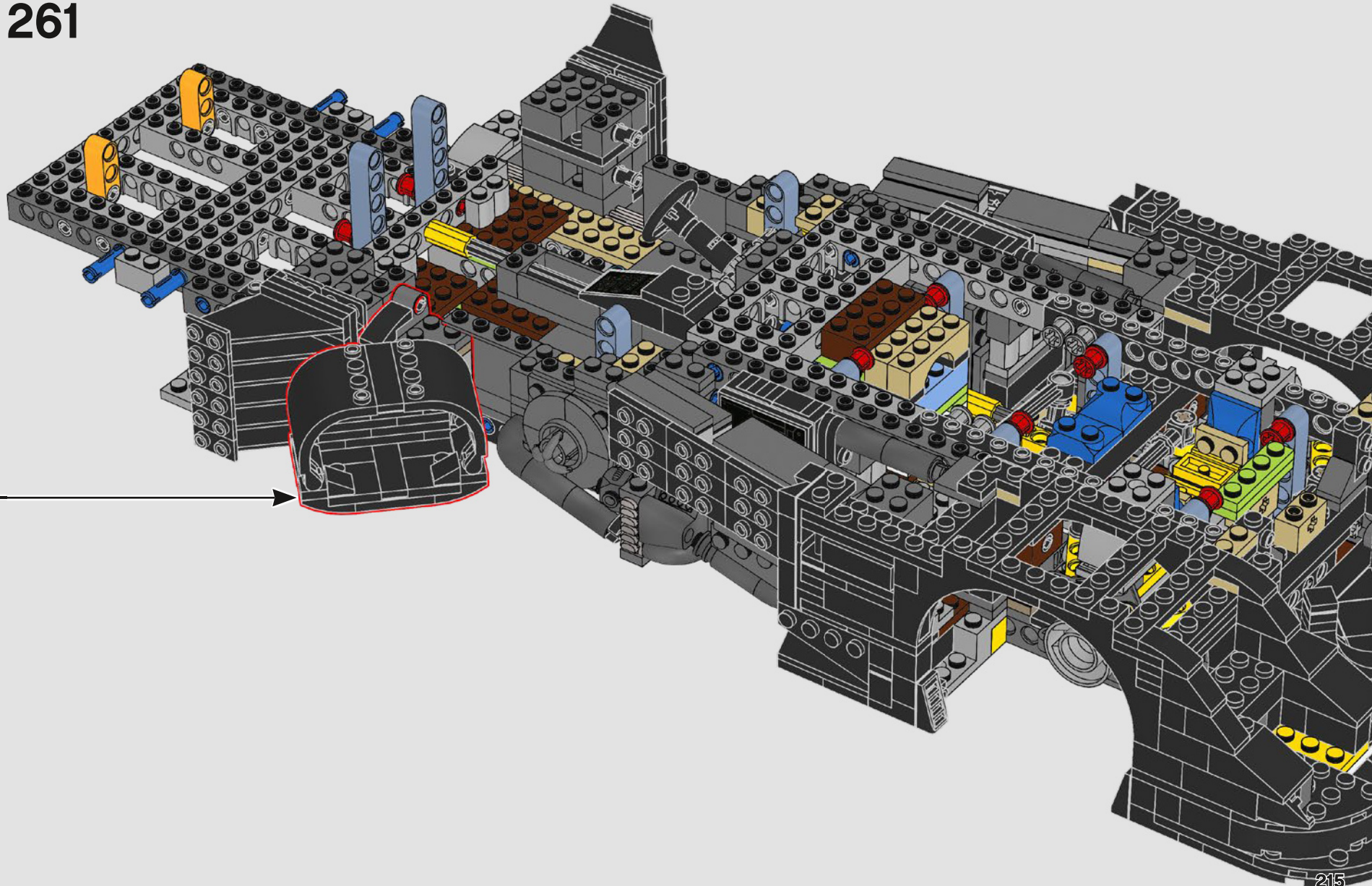

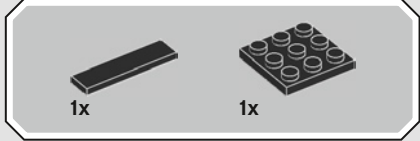
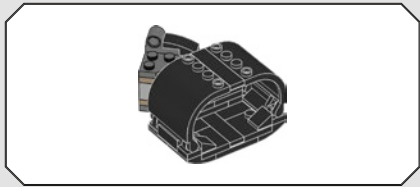

262

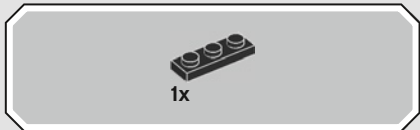
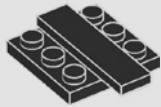

263

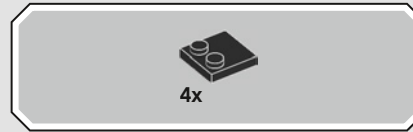
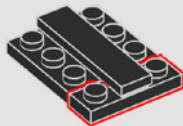

264

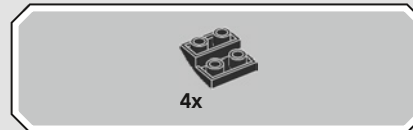
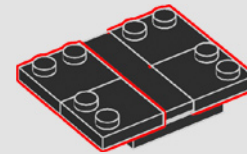

265

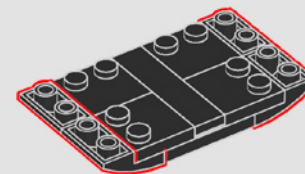





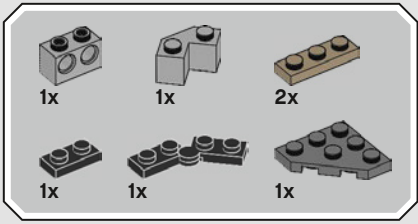

# 270

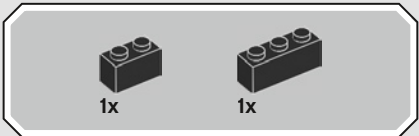
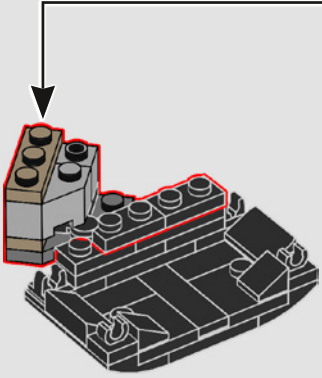
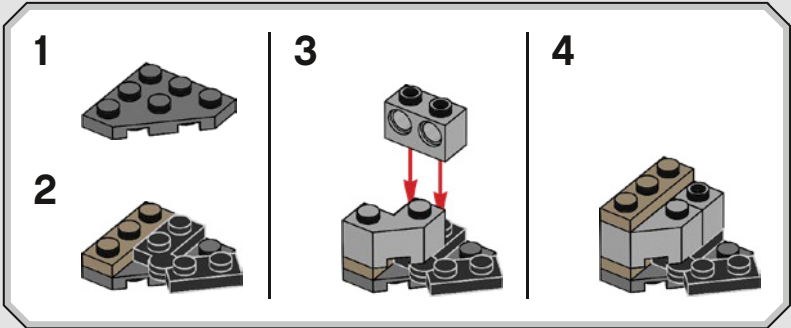

# 271

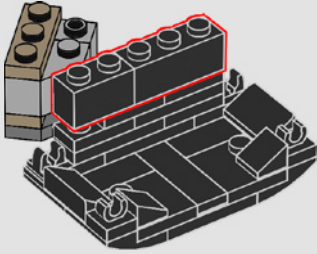

# 272

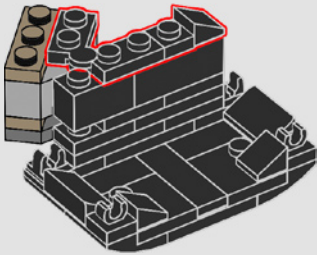

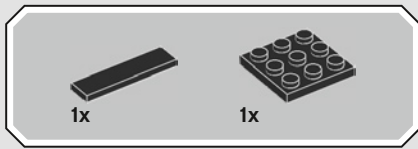

273

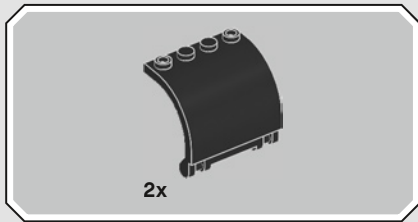
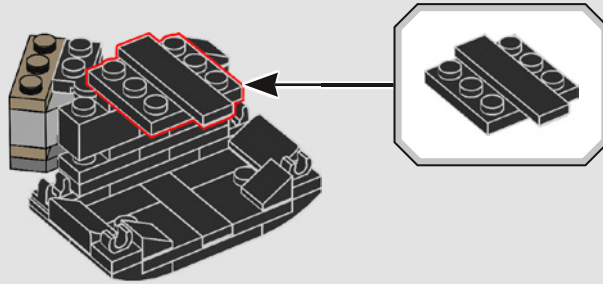

274

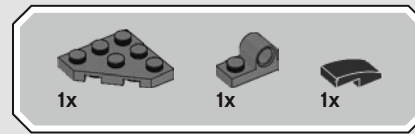
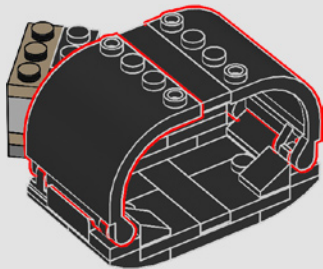

275

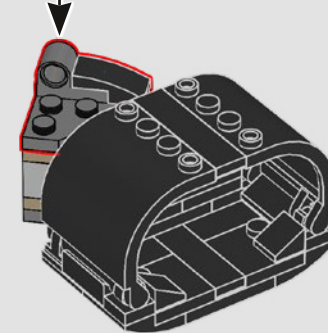
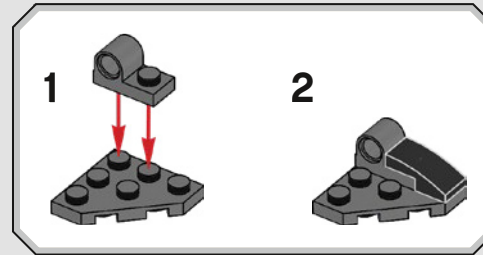

276

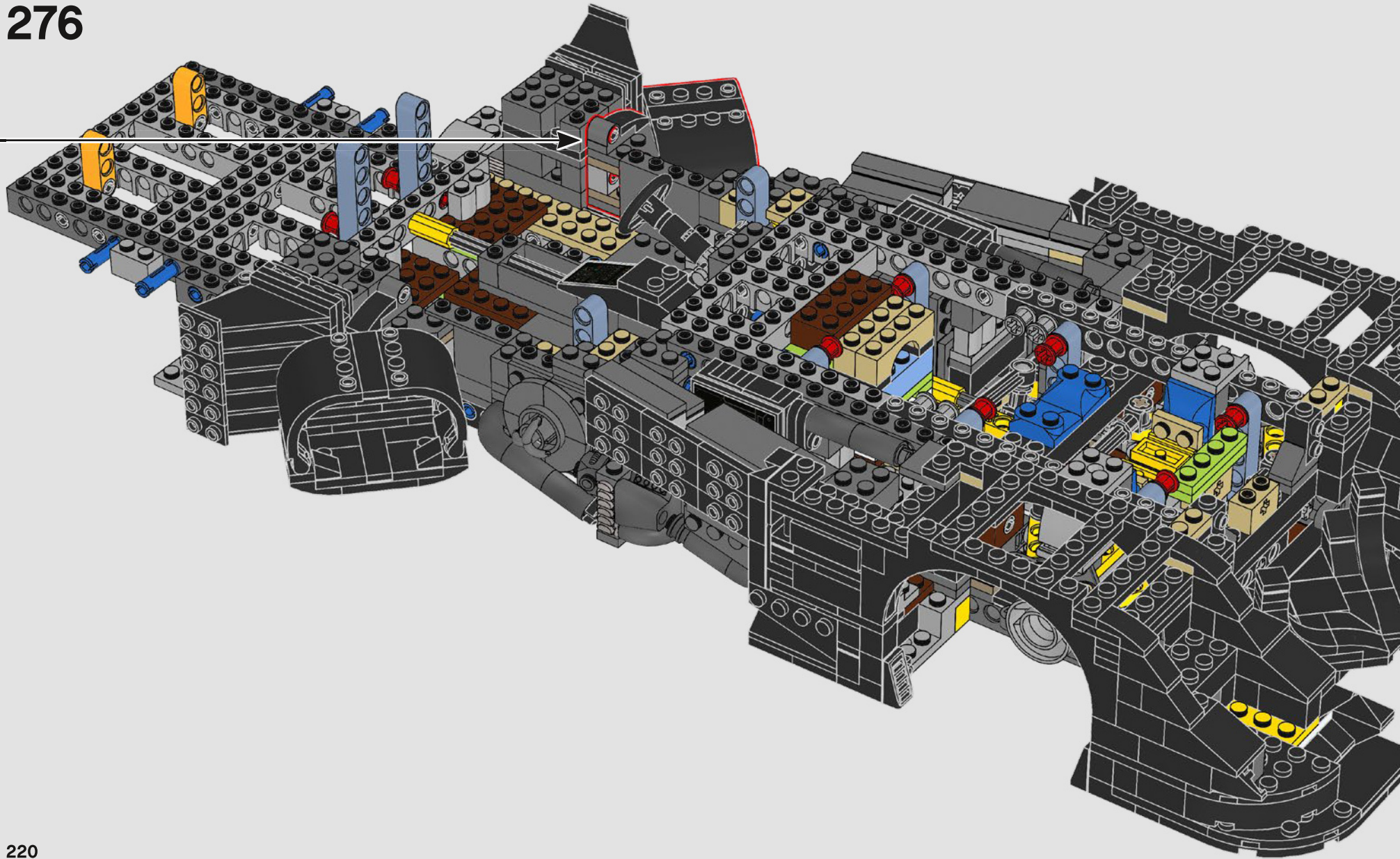



2x

277

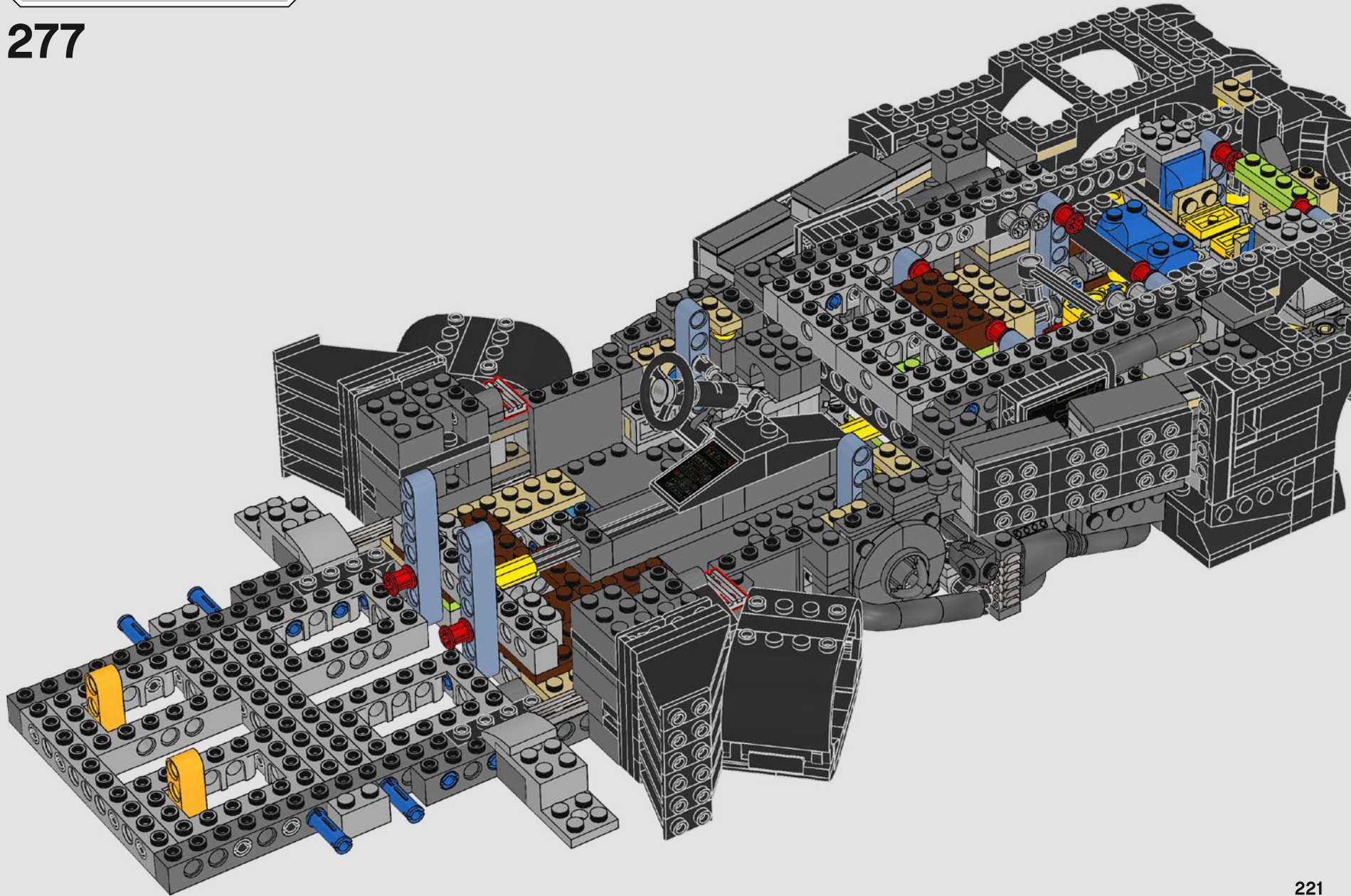

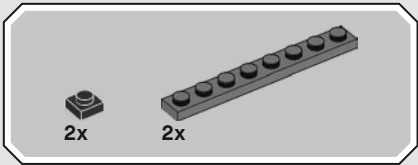

278

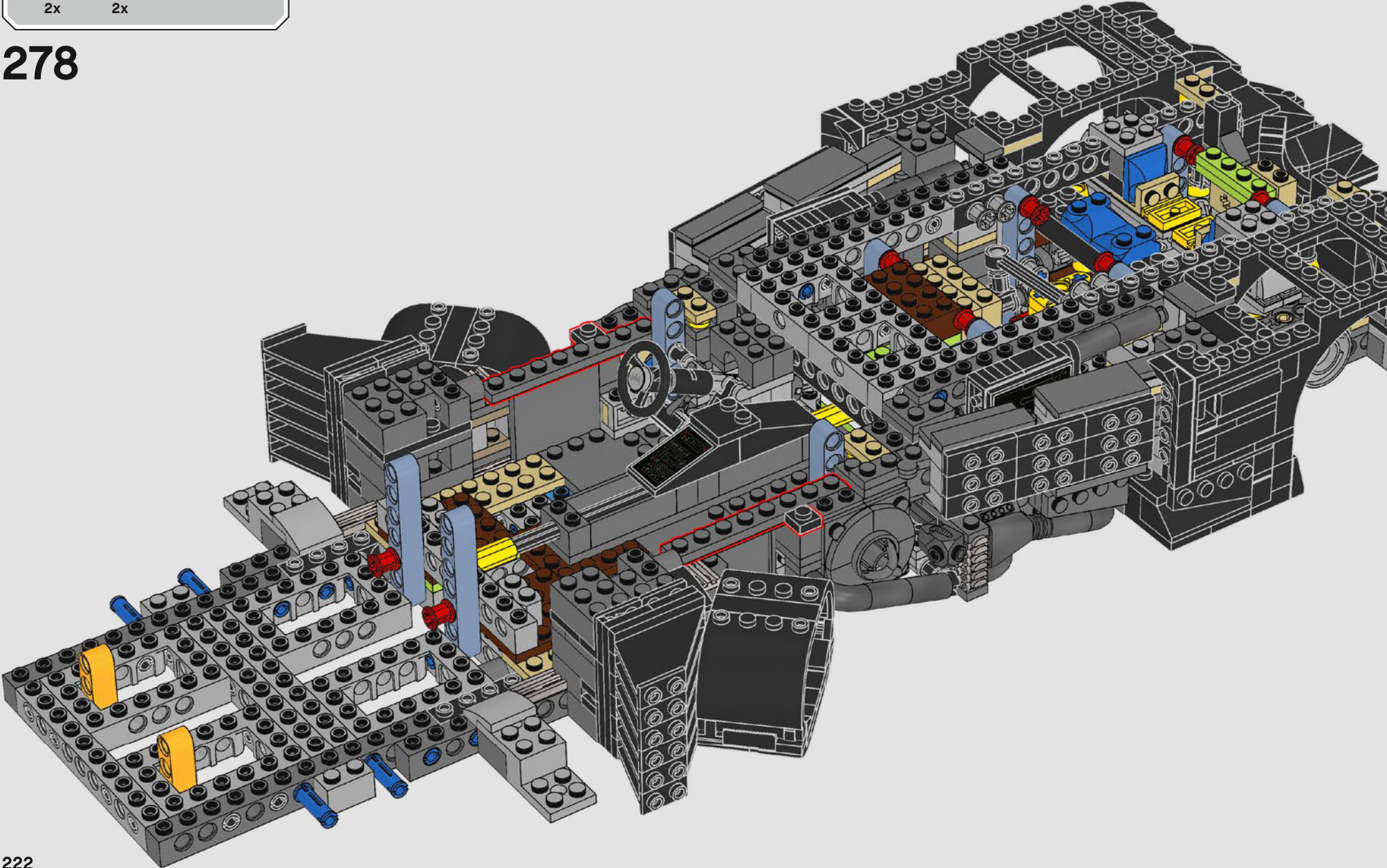

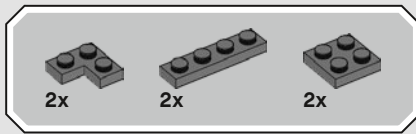

279

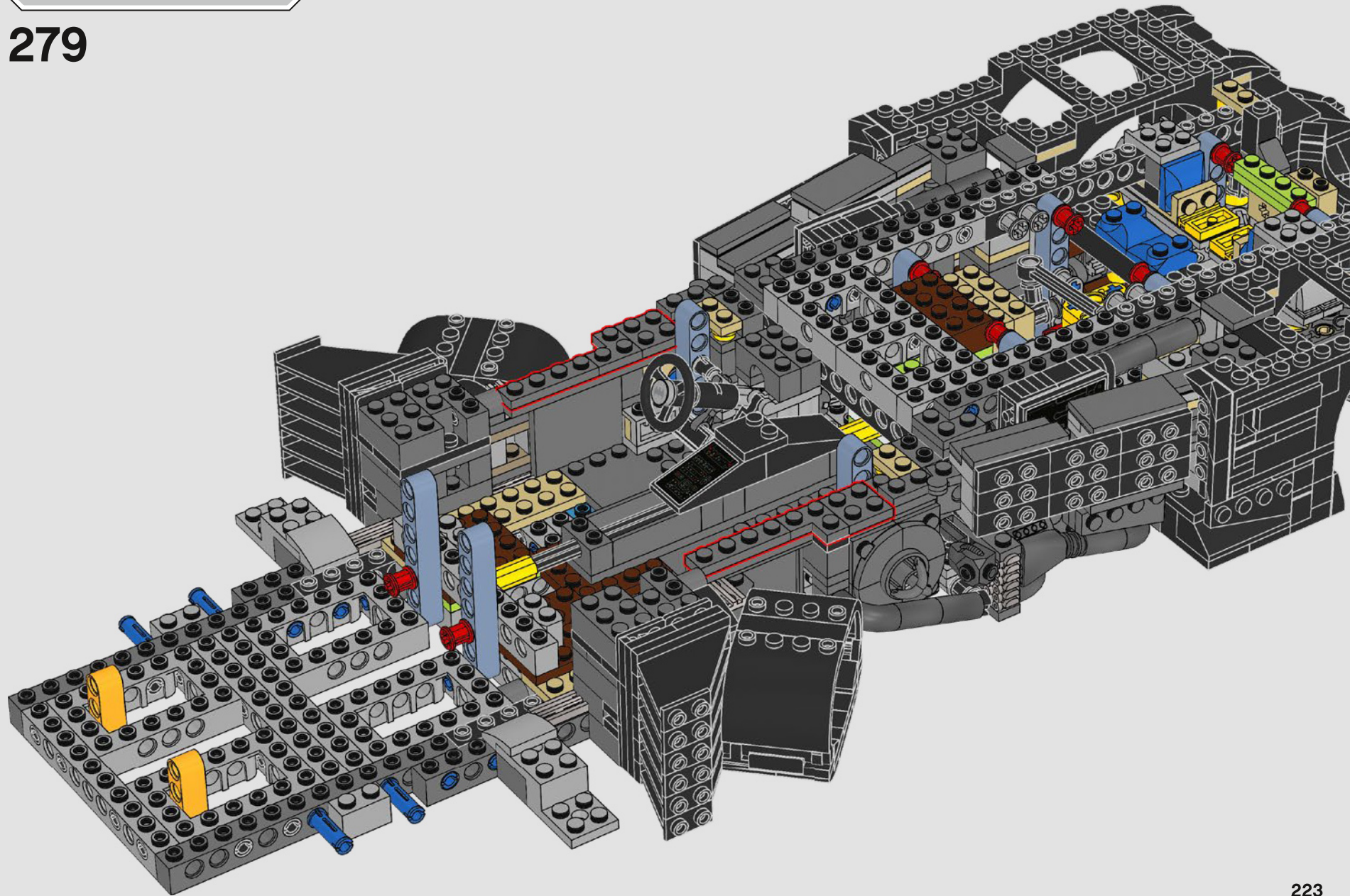

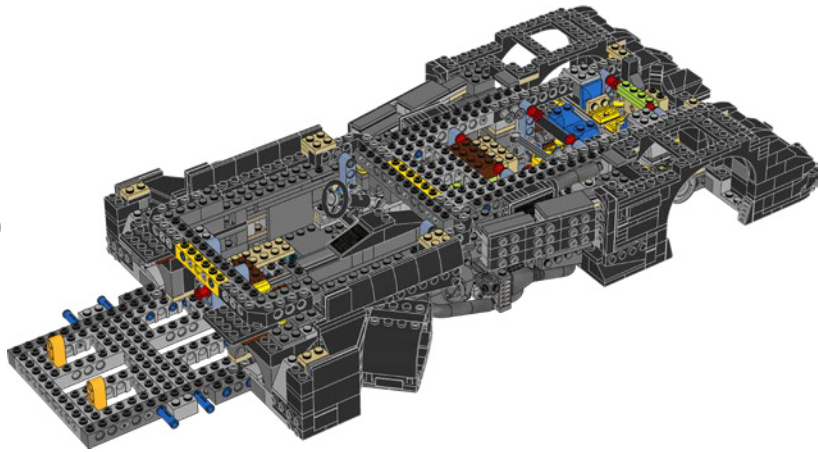
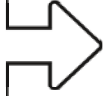

2x

280

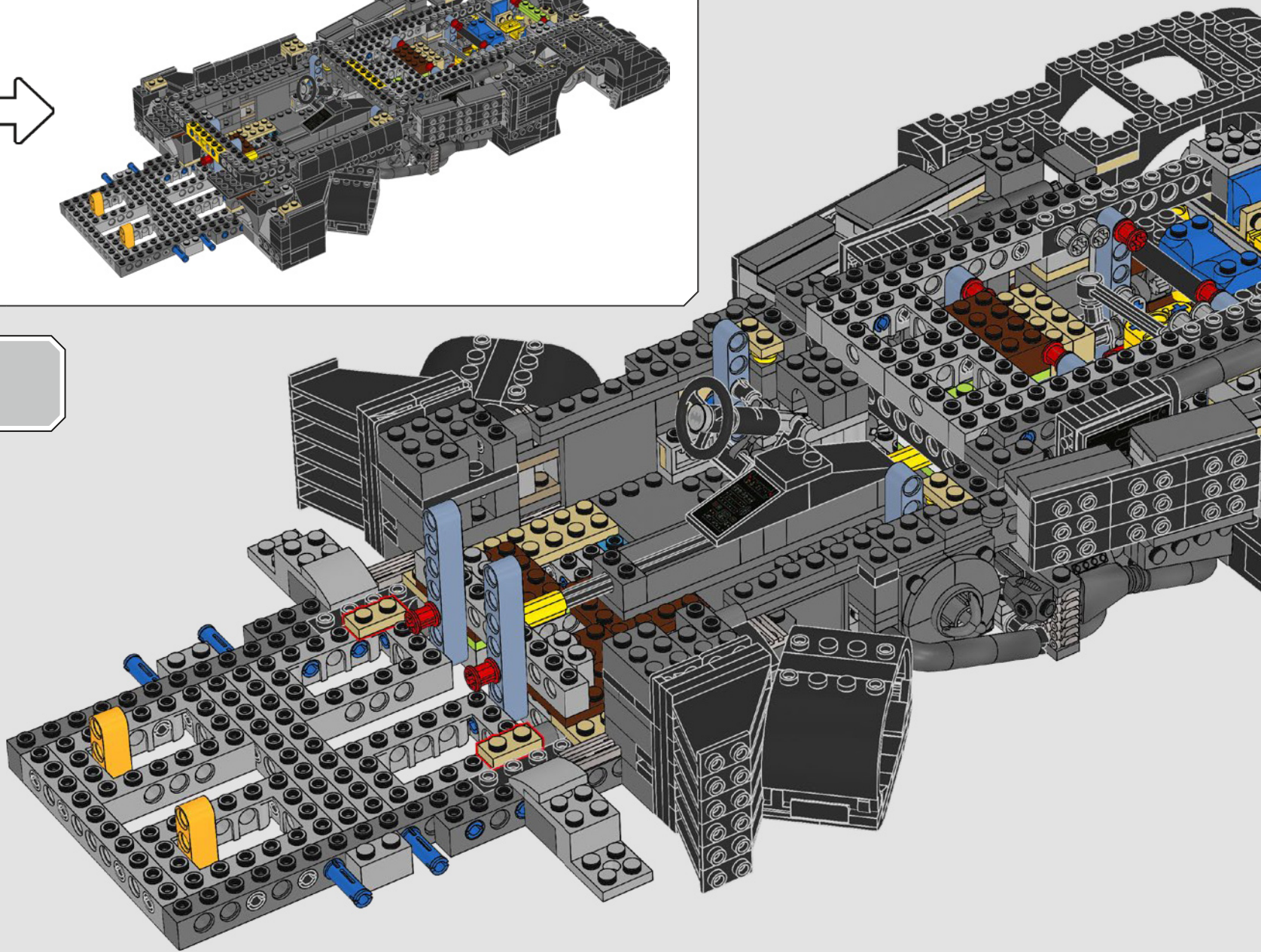



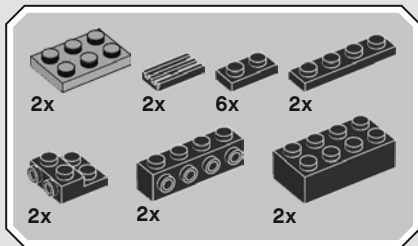

281

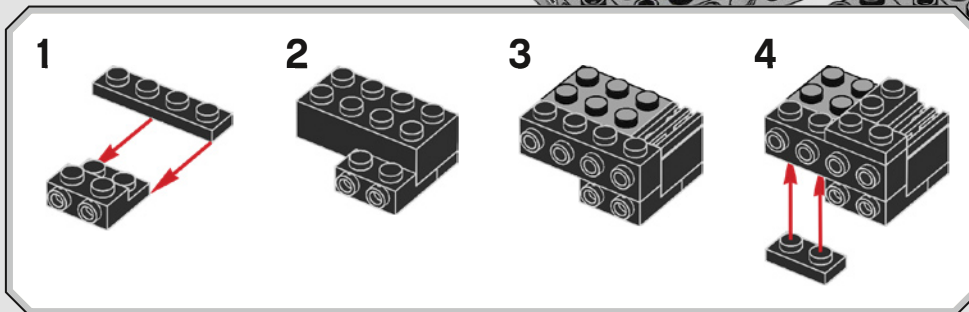
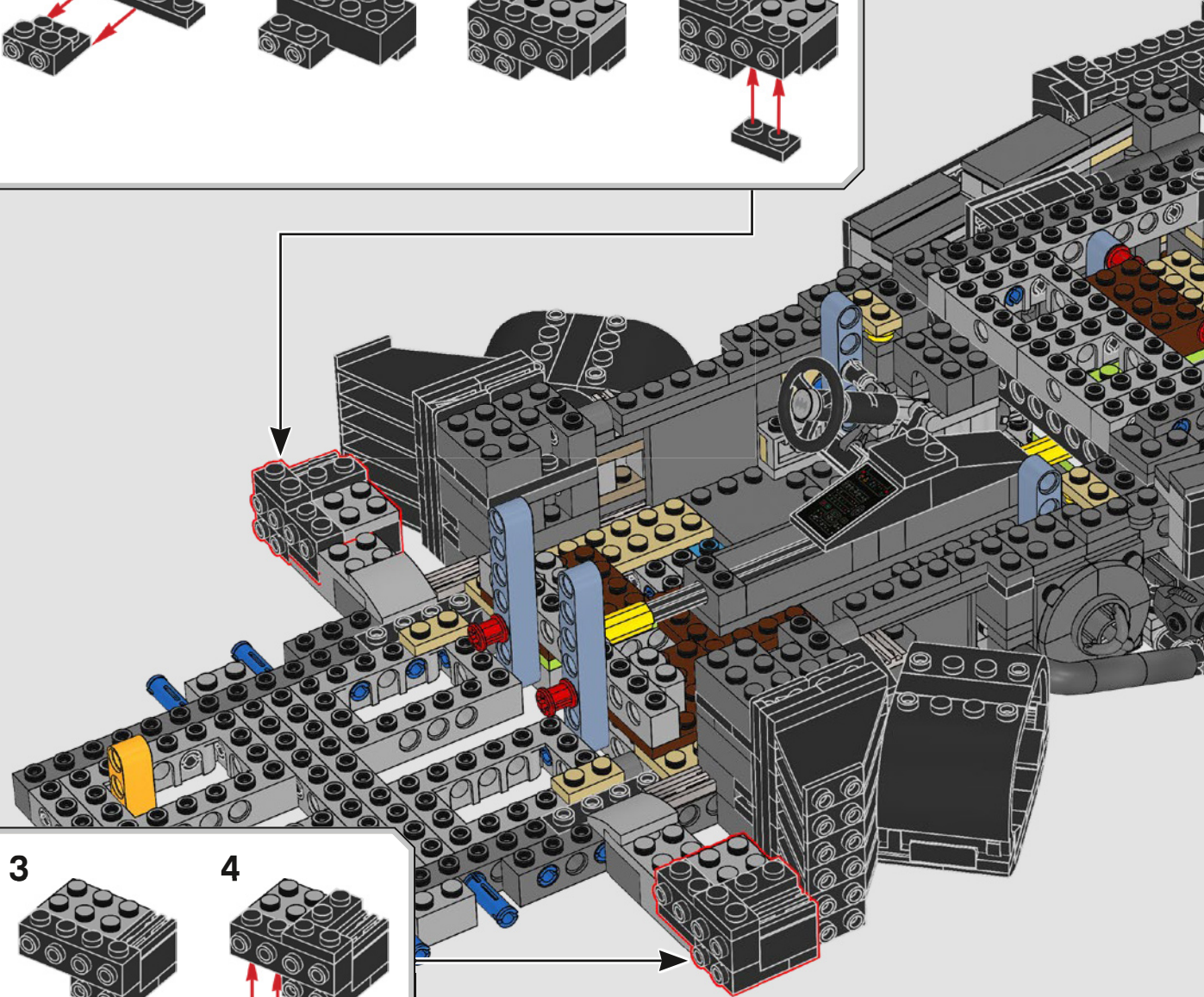
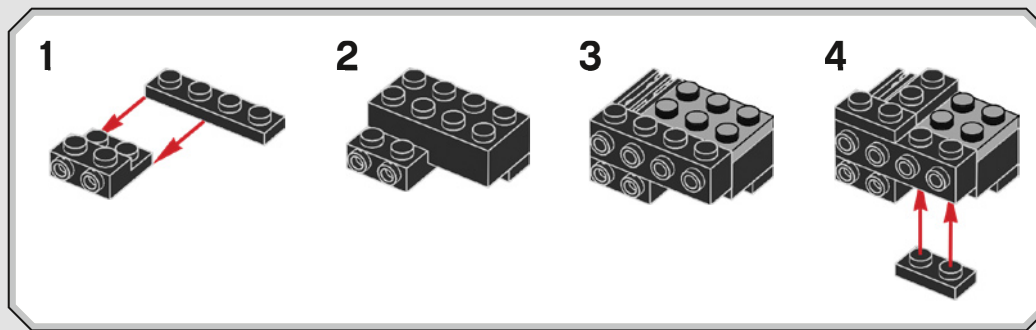



2x



2x

282

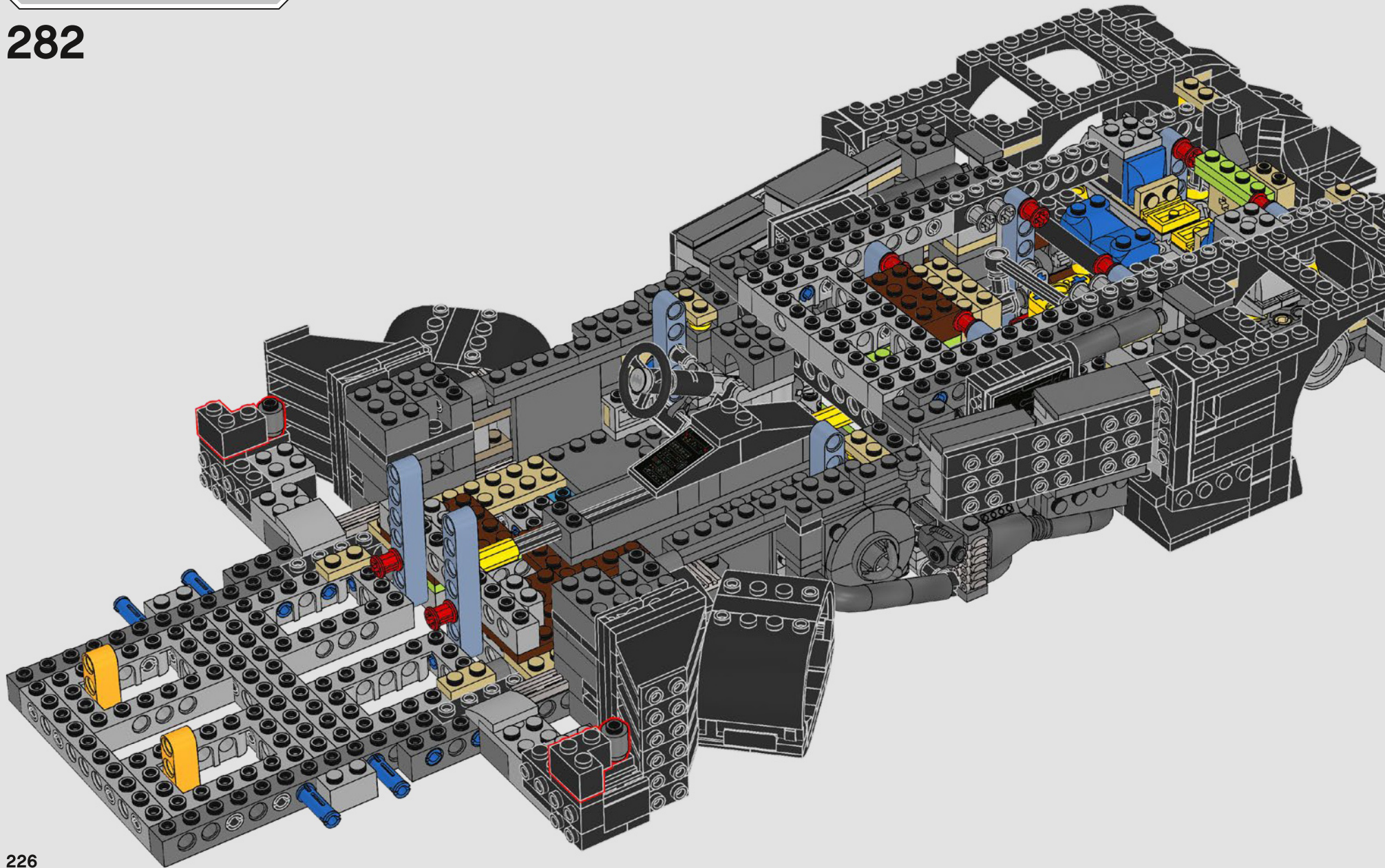

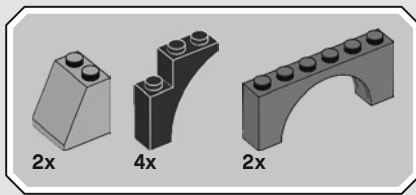

283

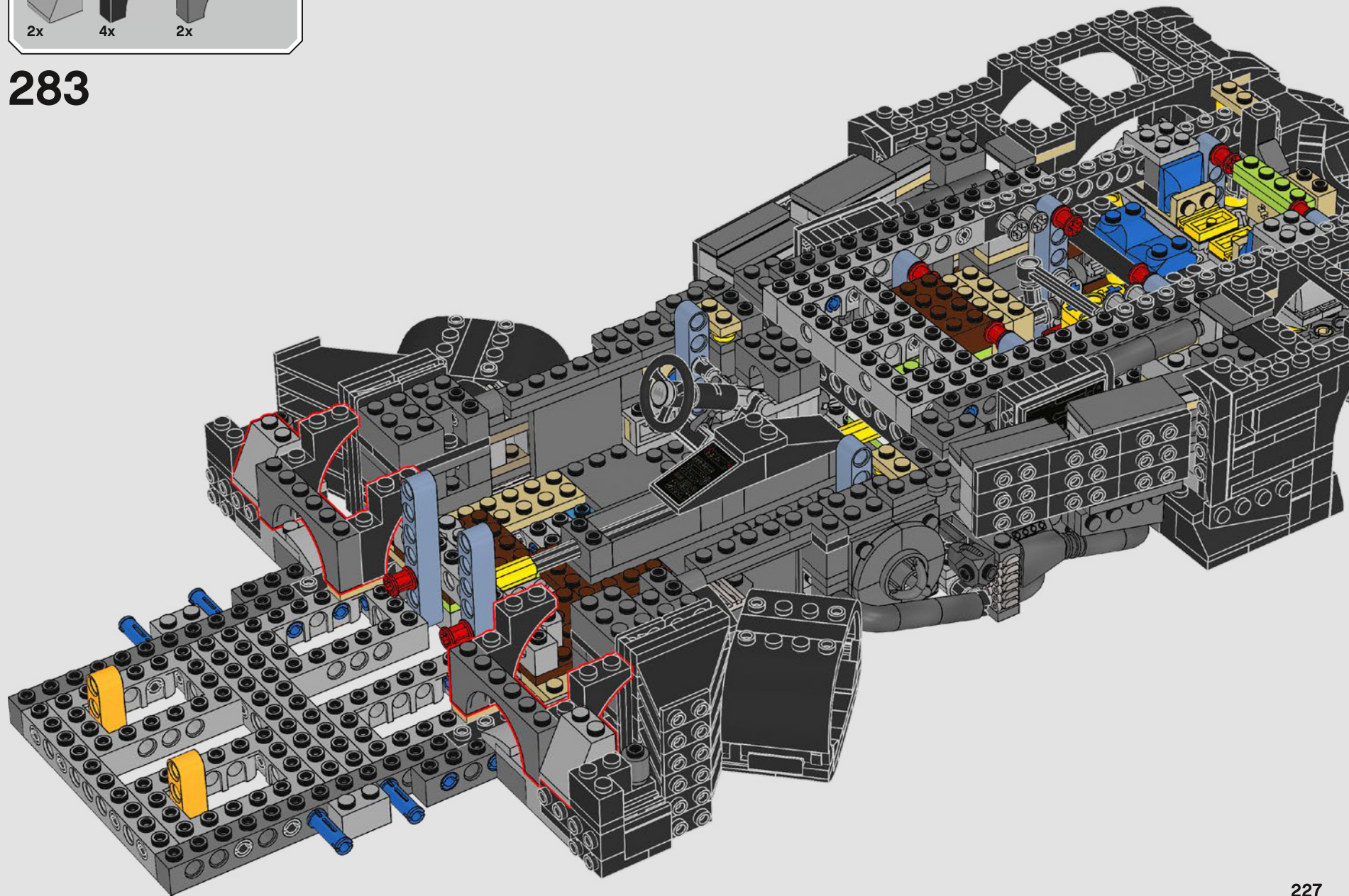

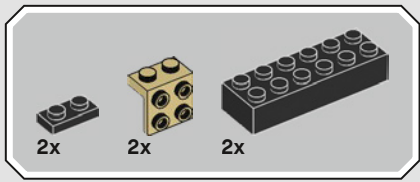

284

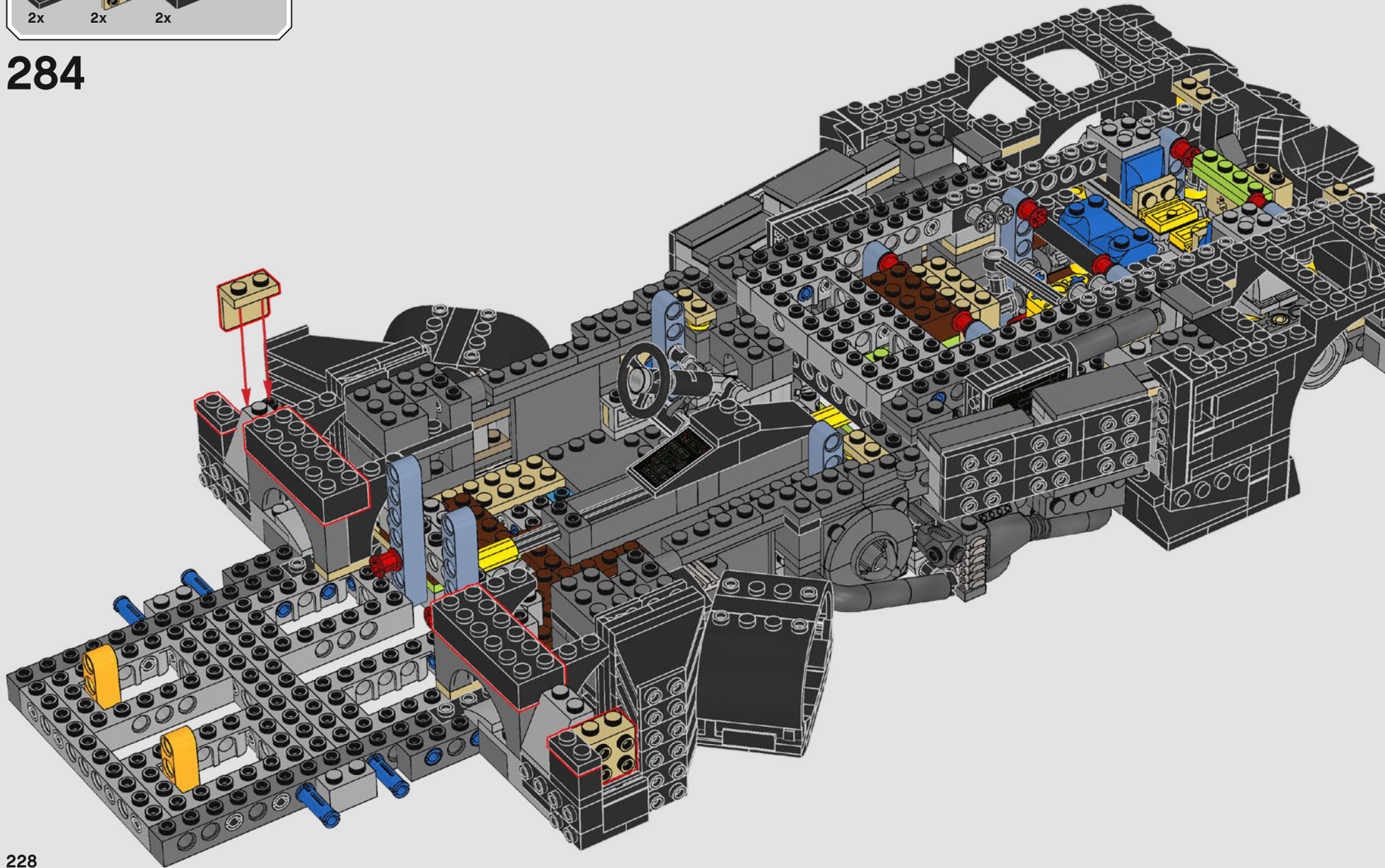

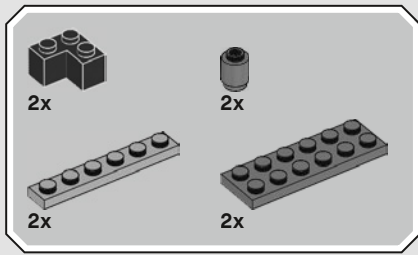

285

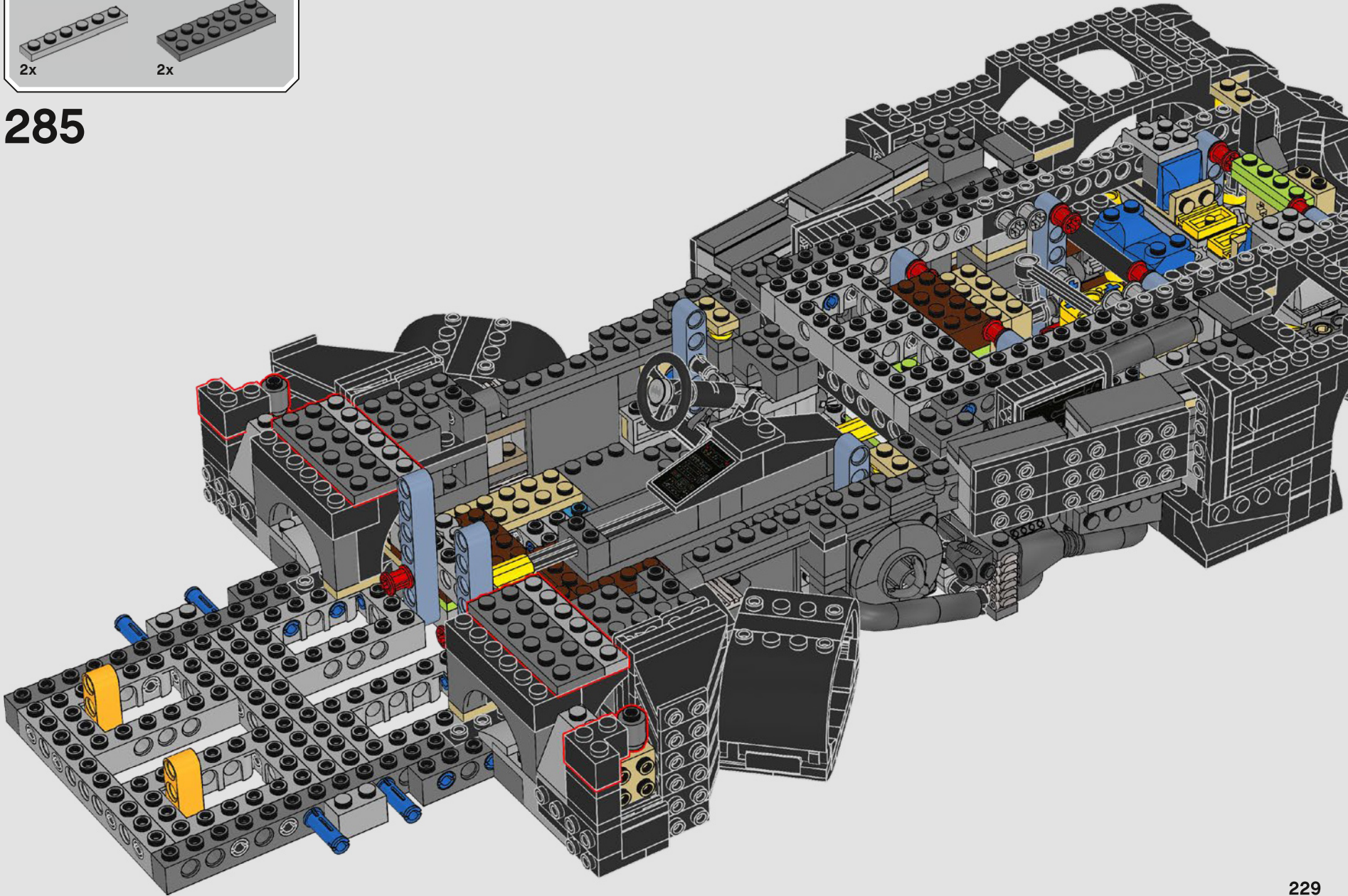

2x  2x 

286

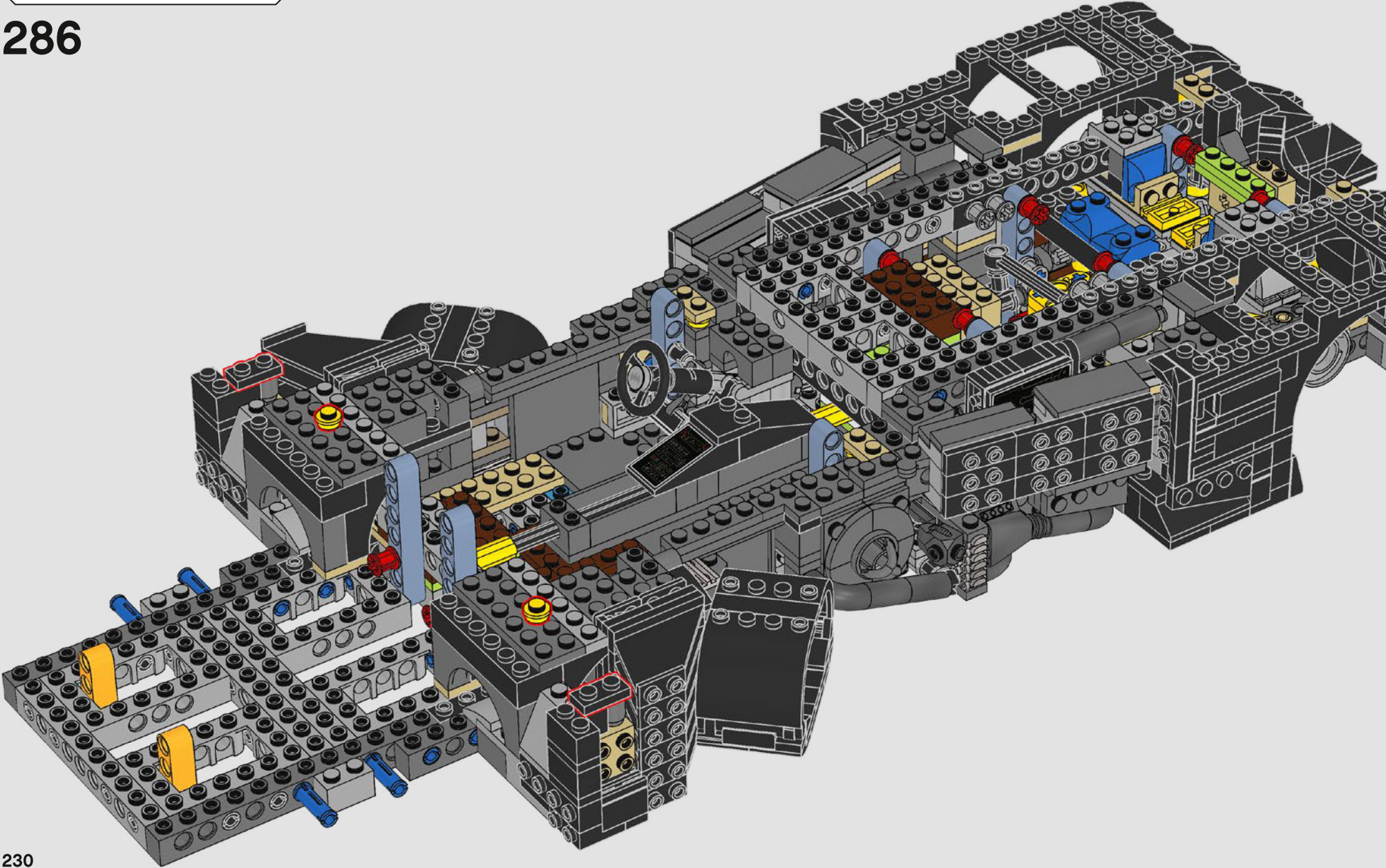

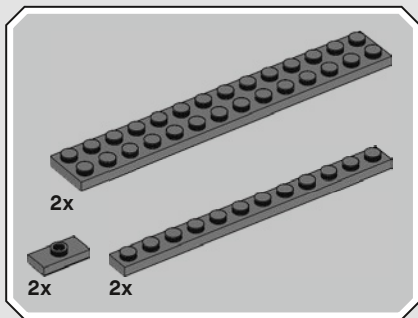

287

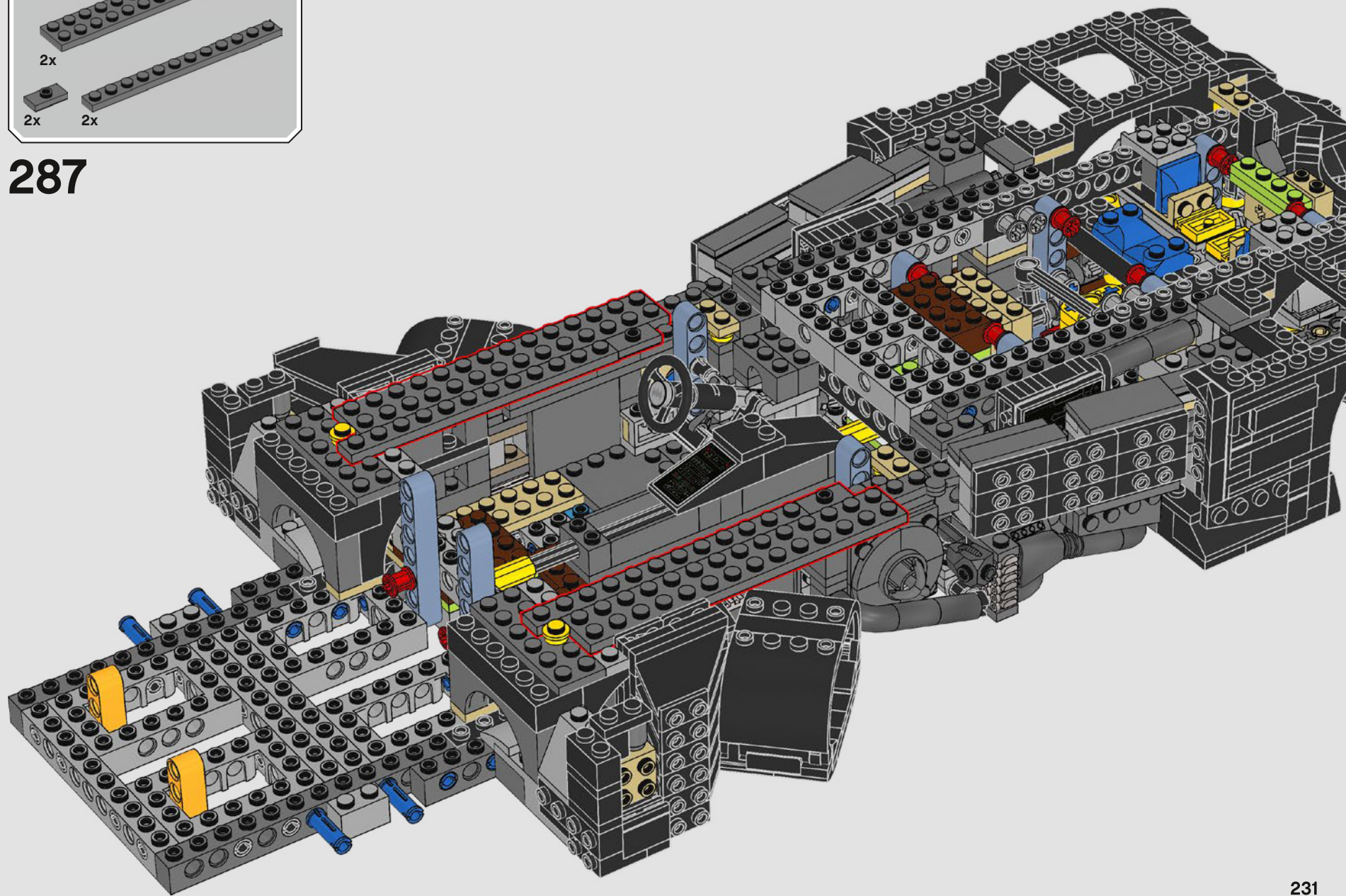

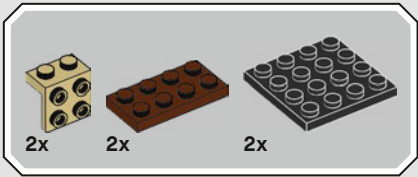

288

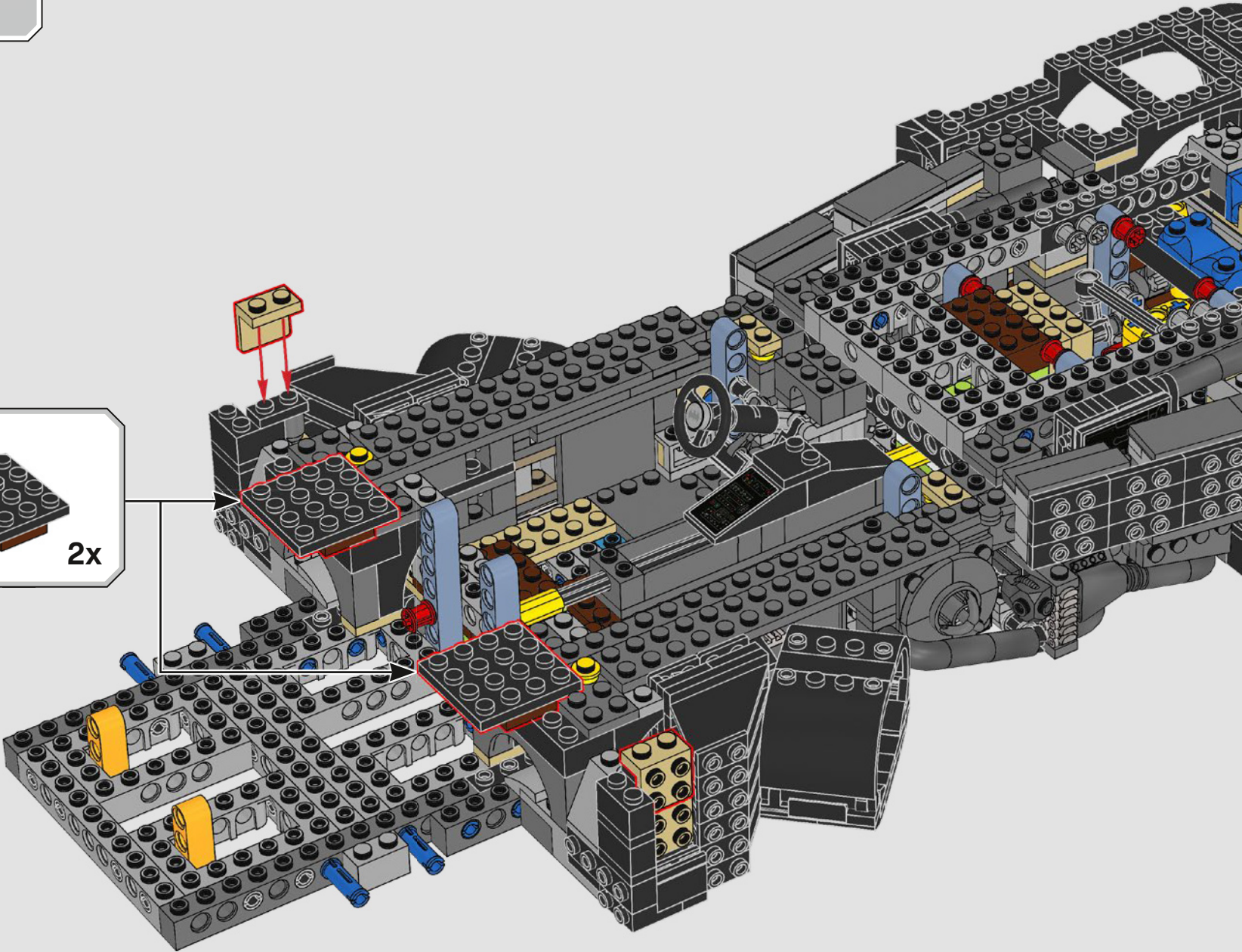
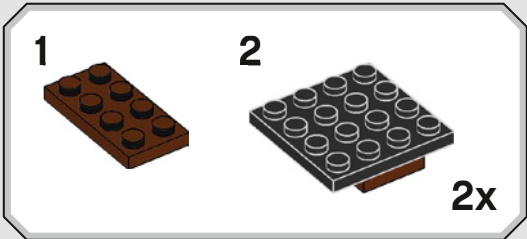



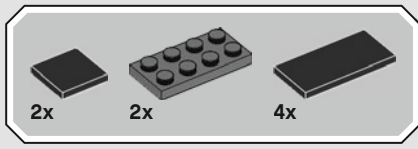

289

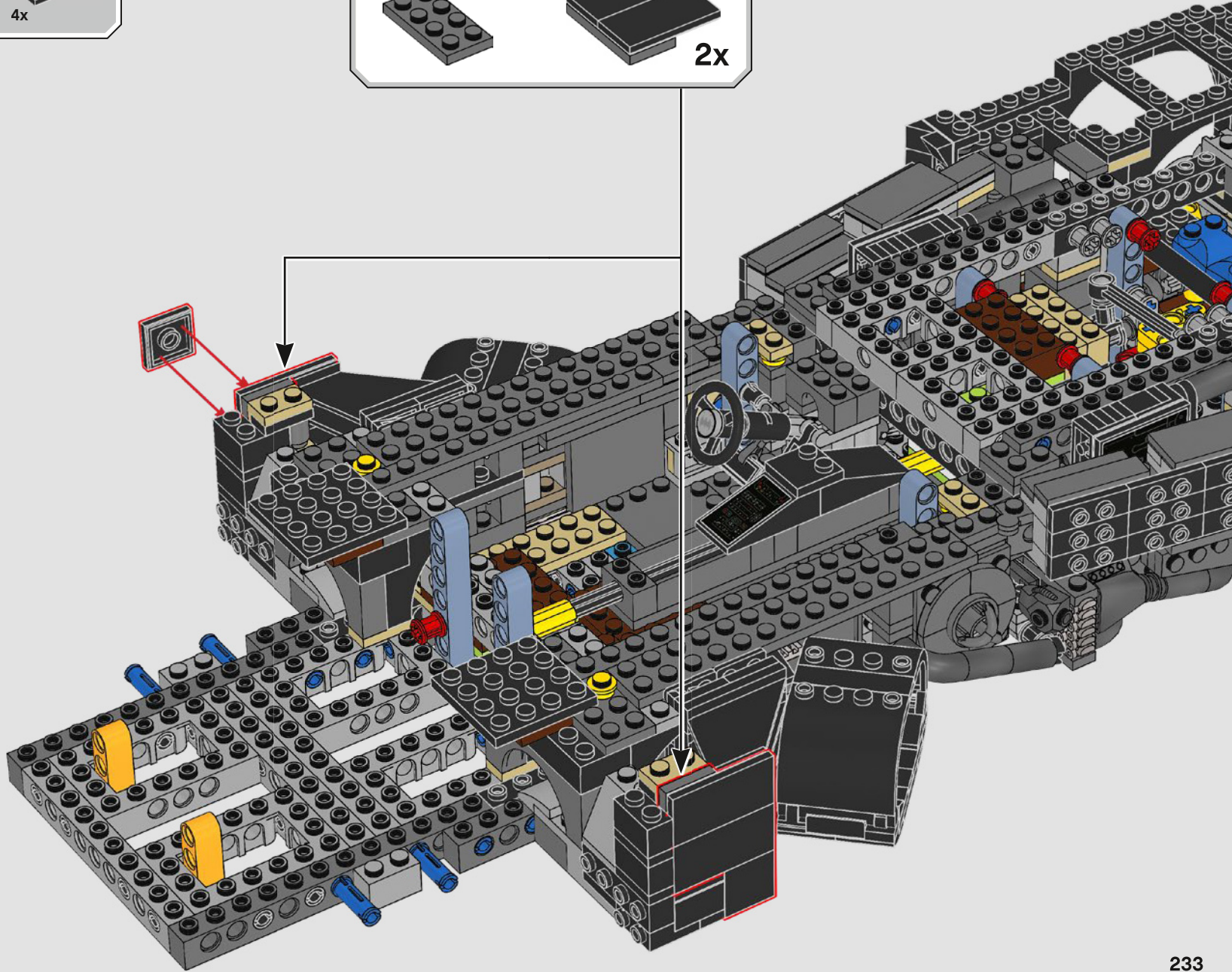
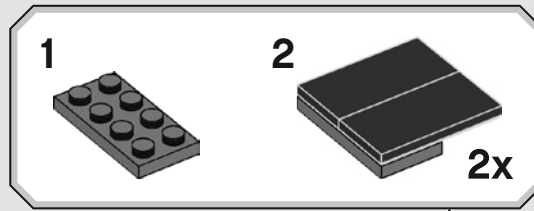

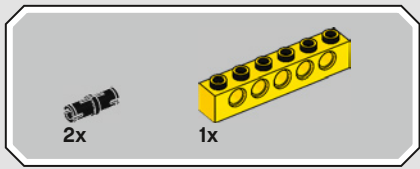

290

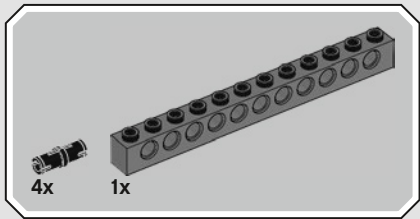
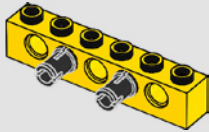

291

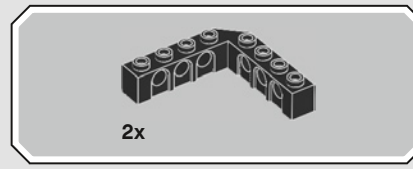
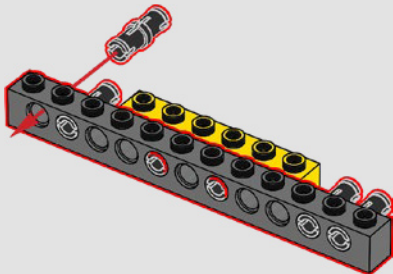

292

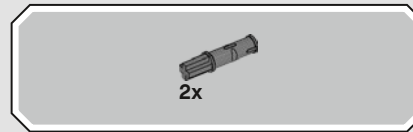
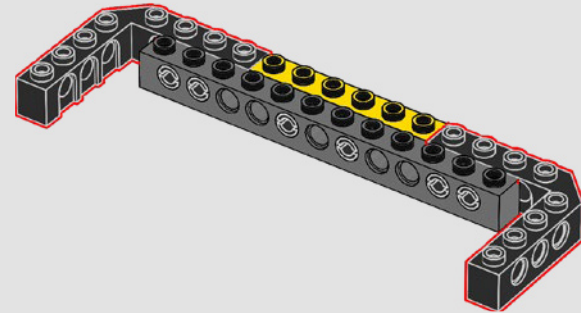

293

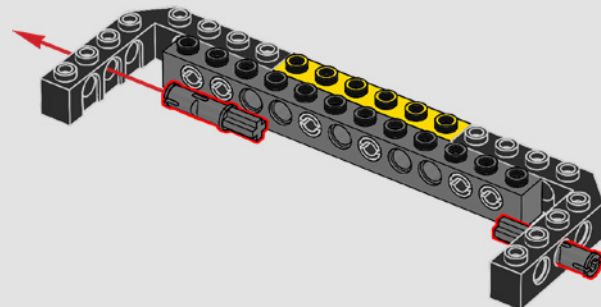

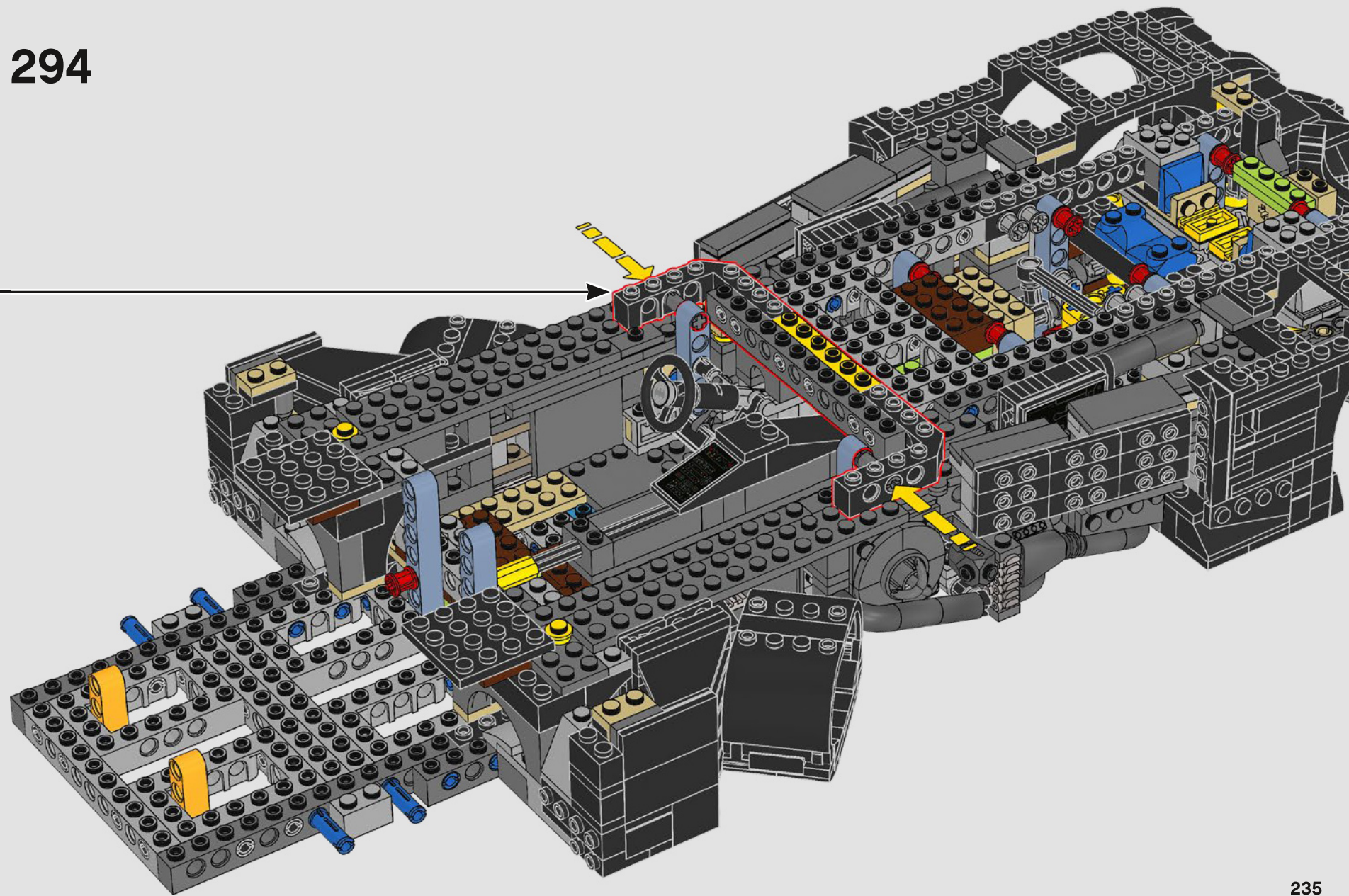



295

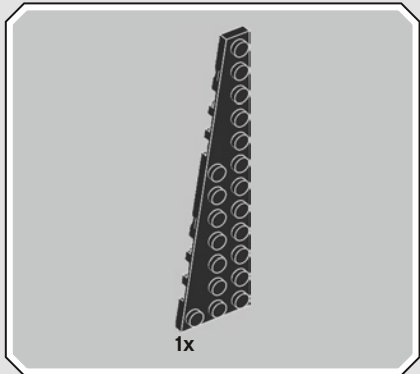
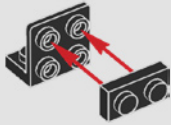

296

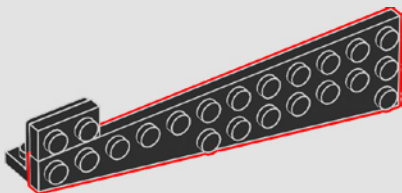

297

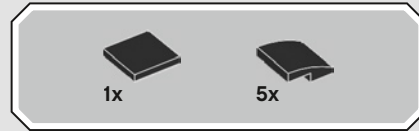
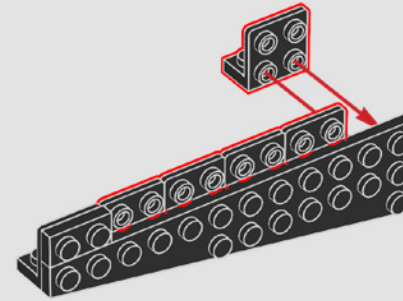

298

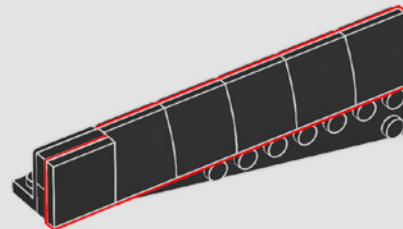

299

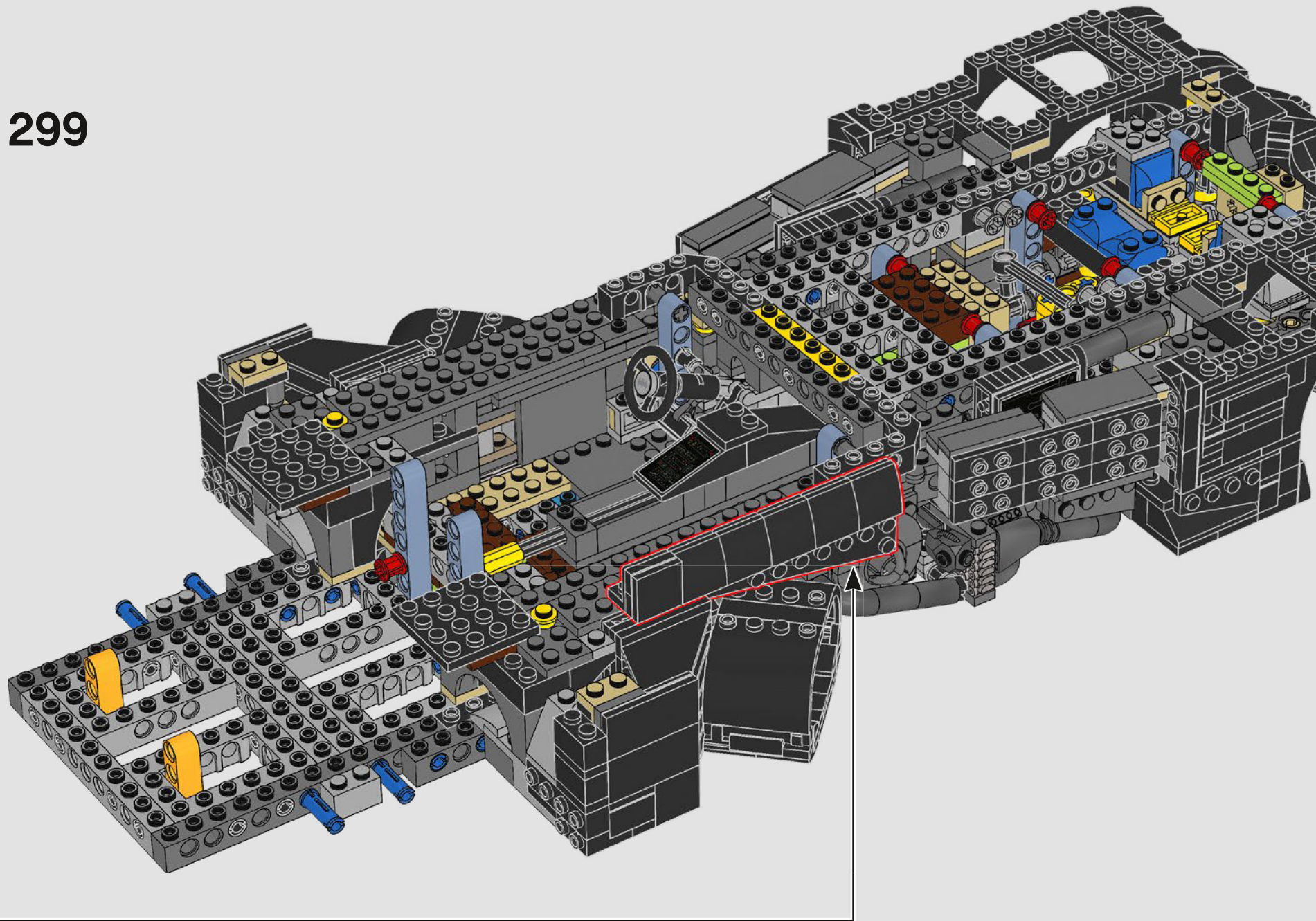



300

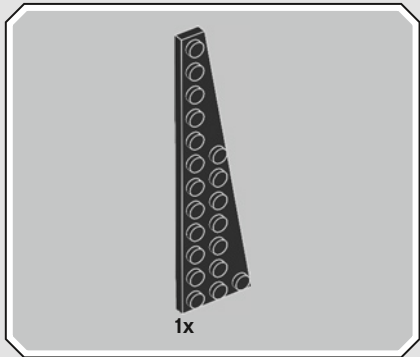
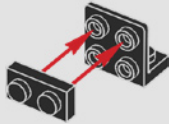

301

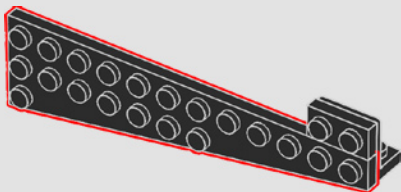

302

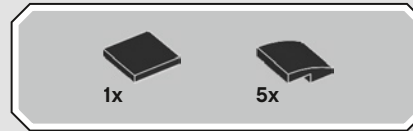
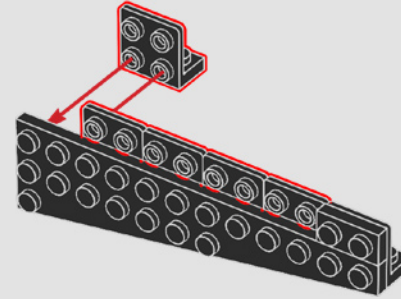

303

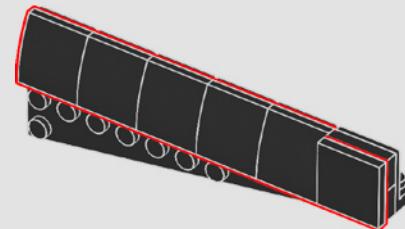

304

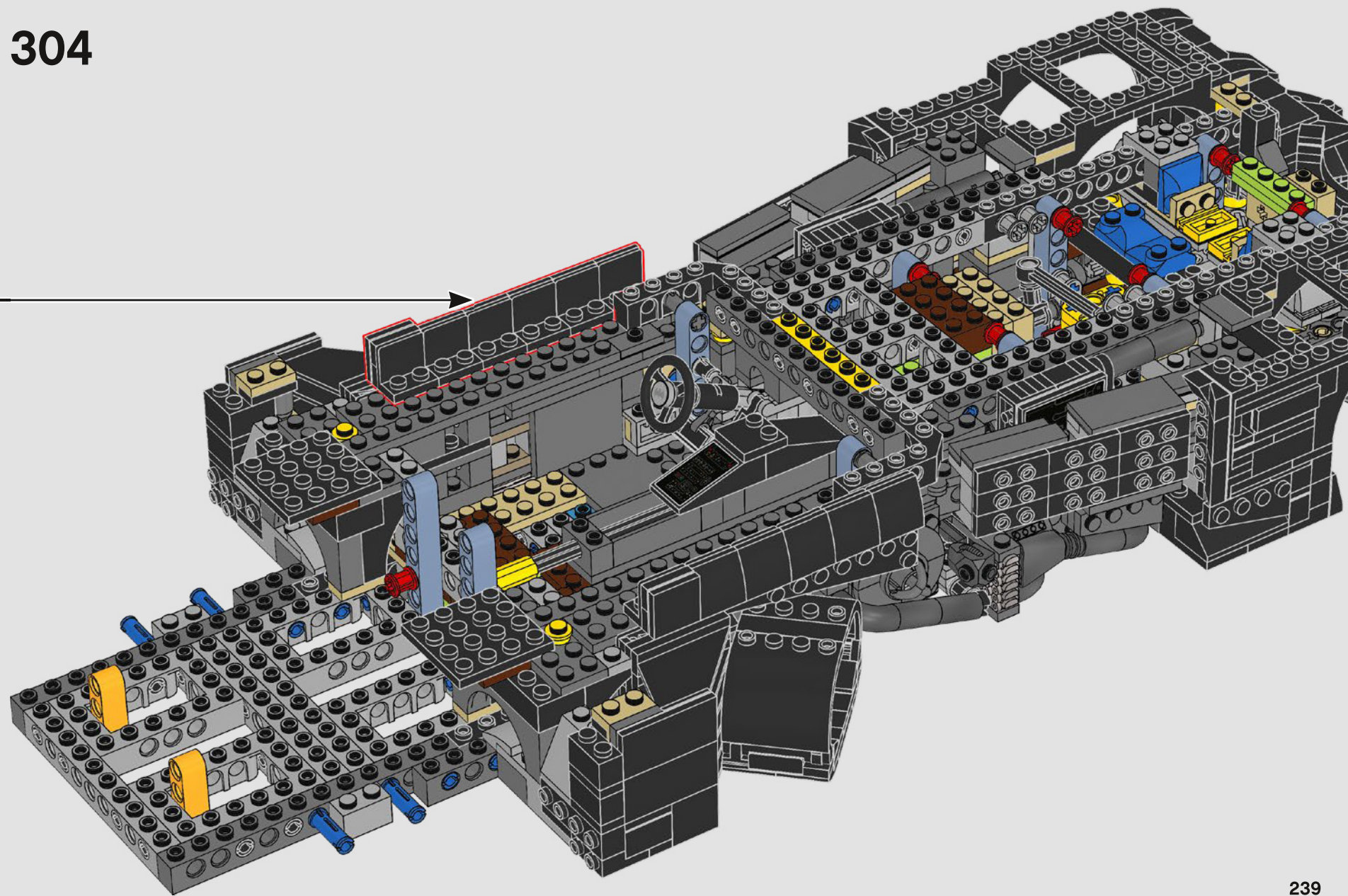

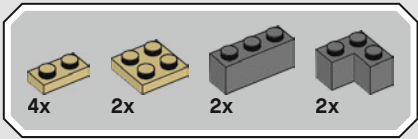

305

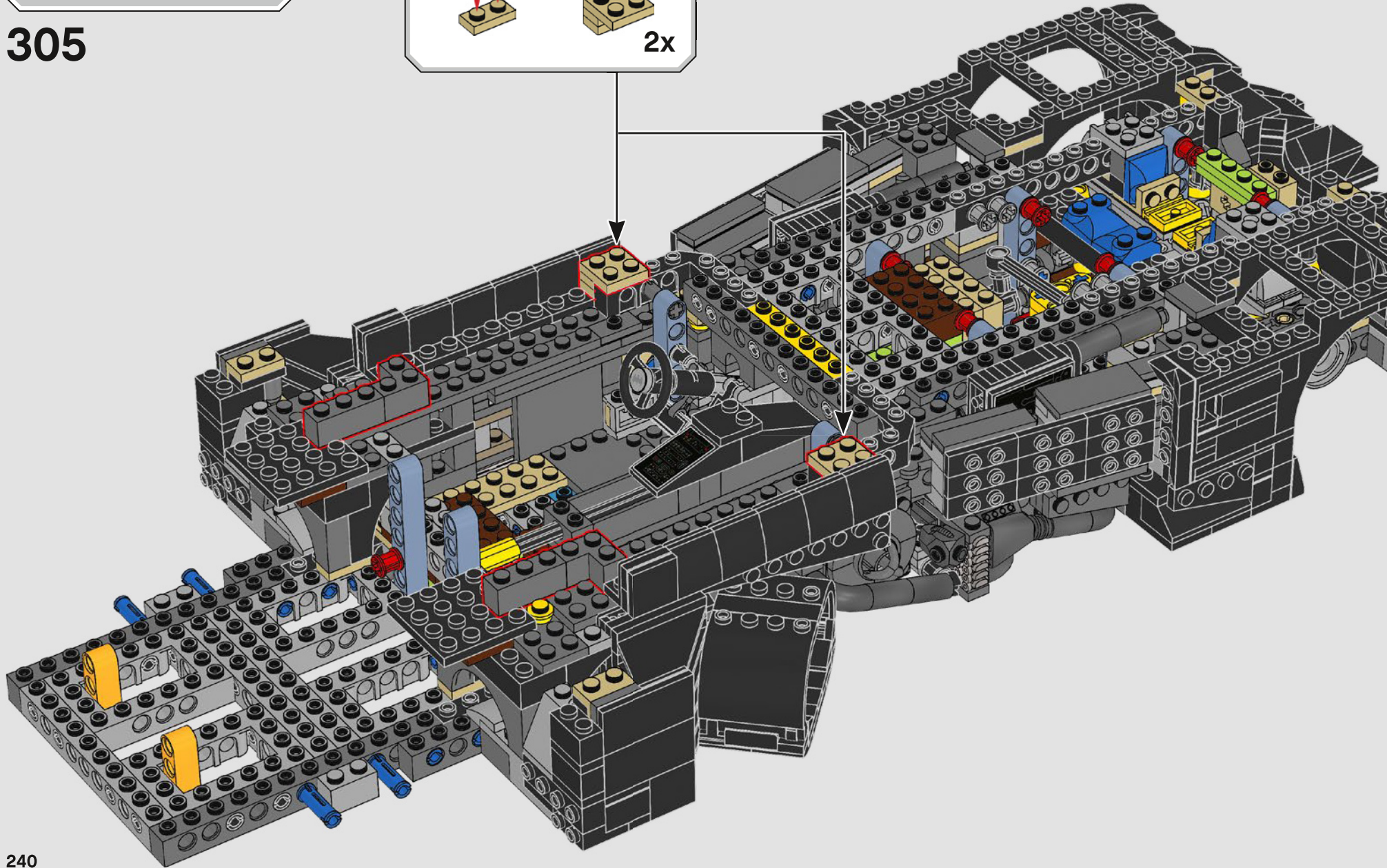
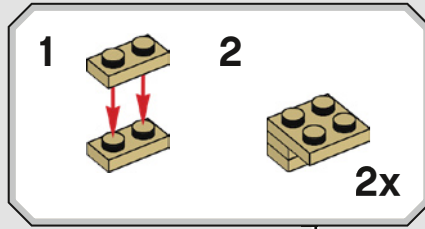



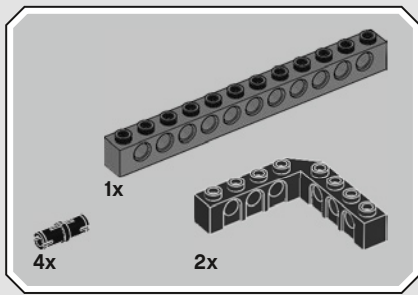

306

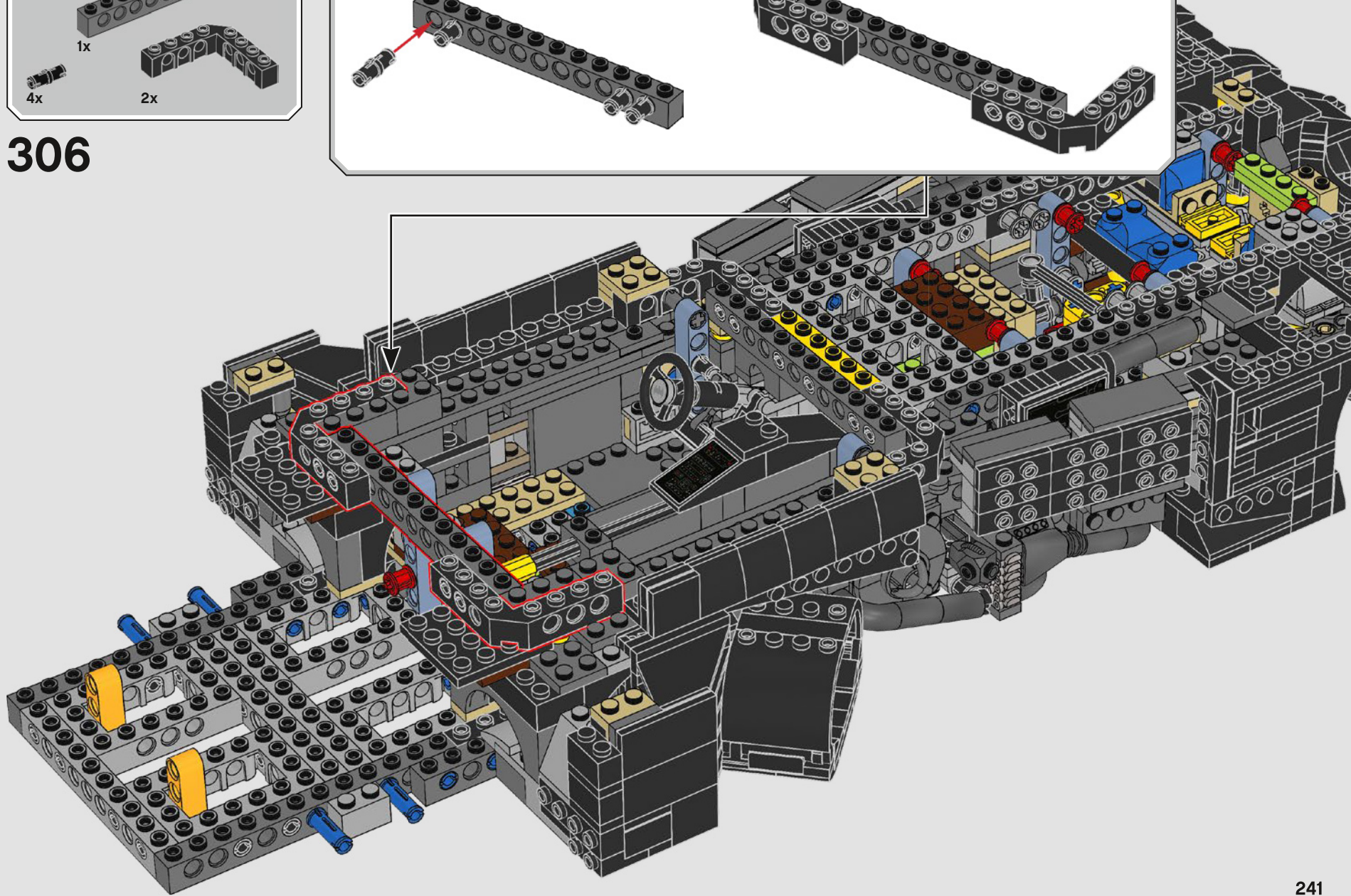
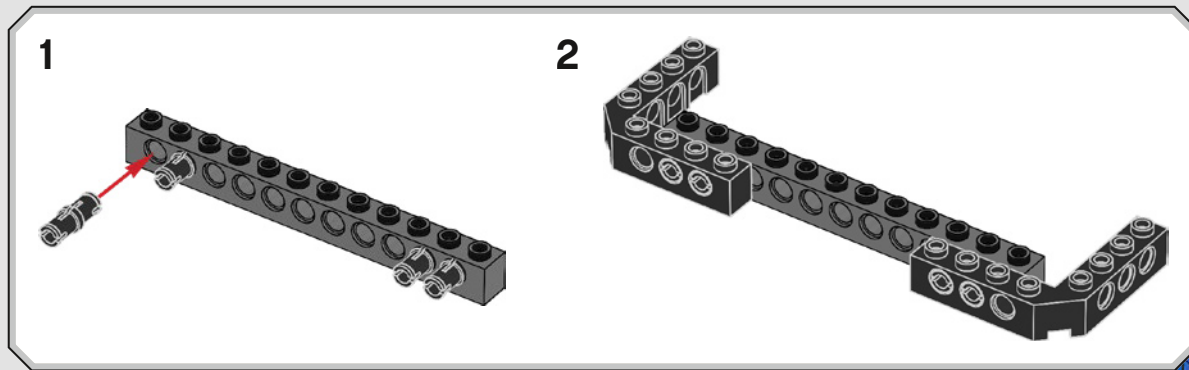

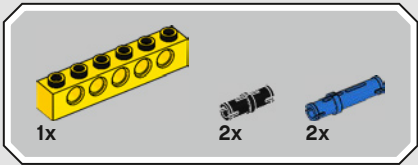

307

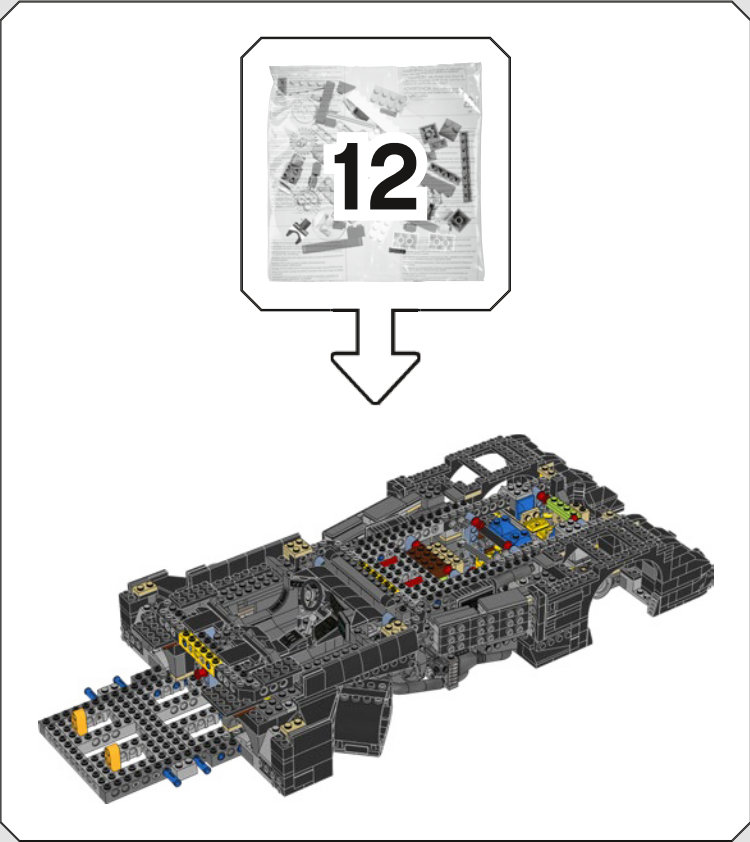
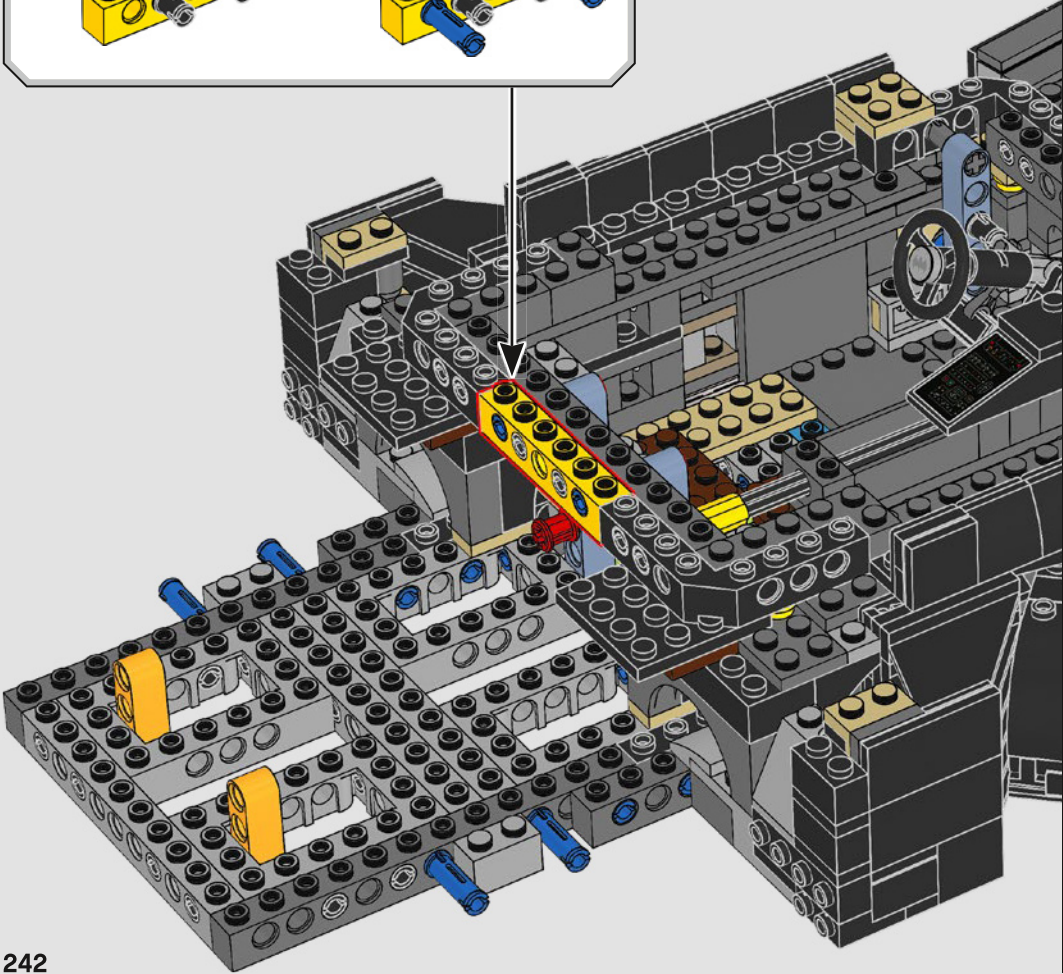
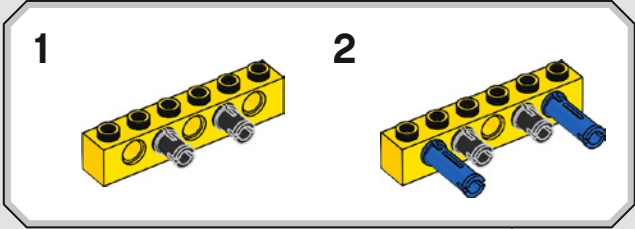

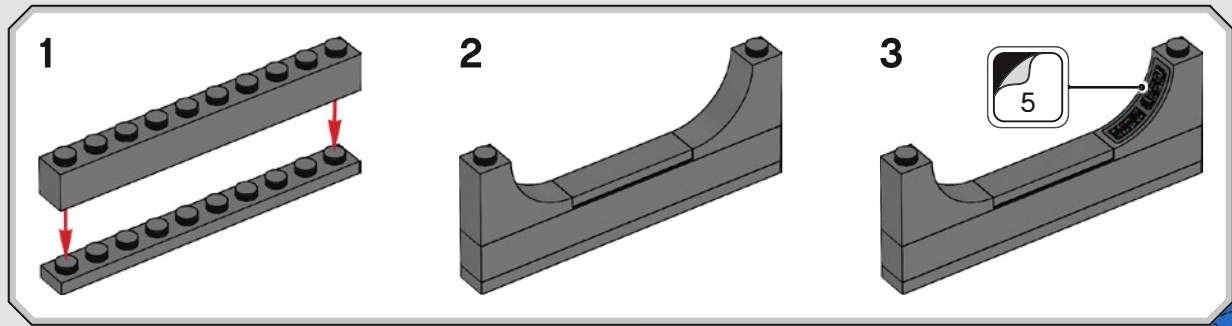
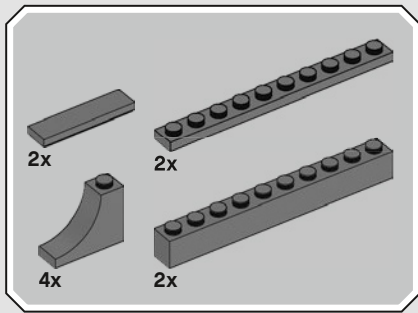

308

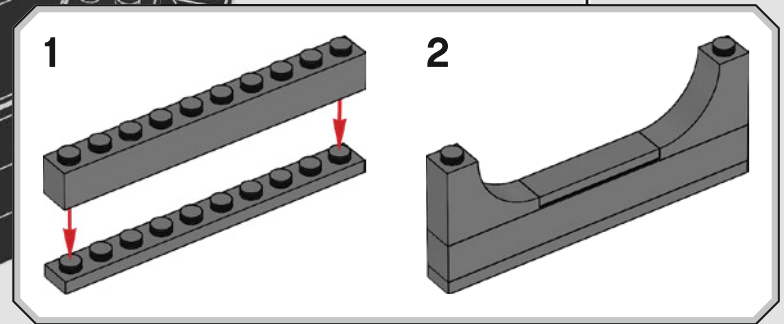
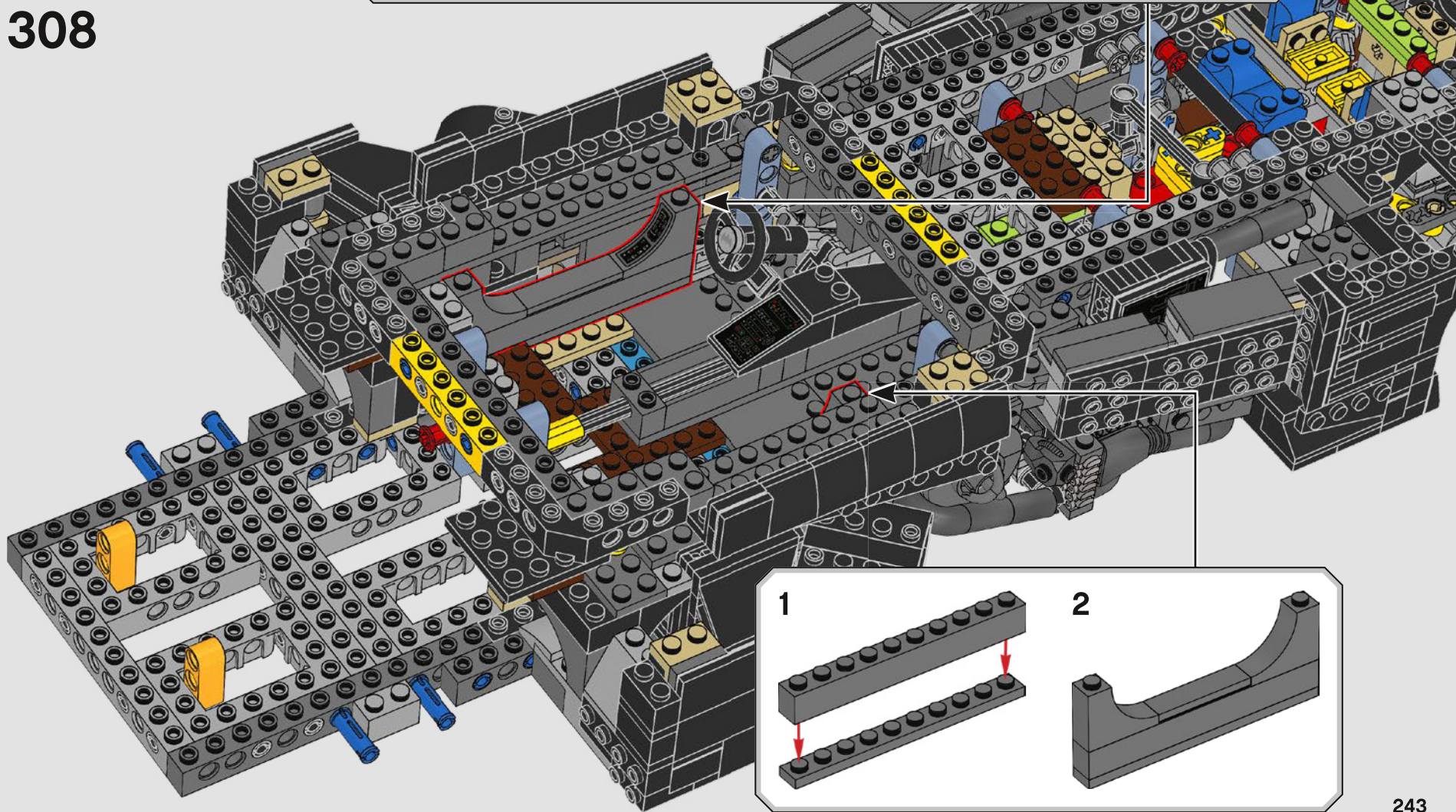

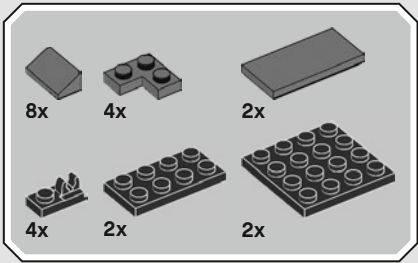

309

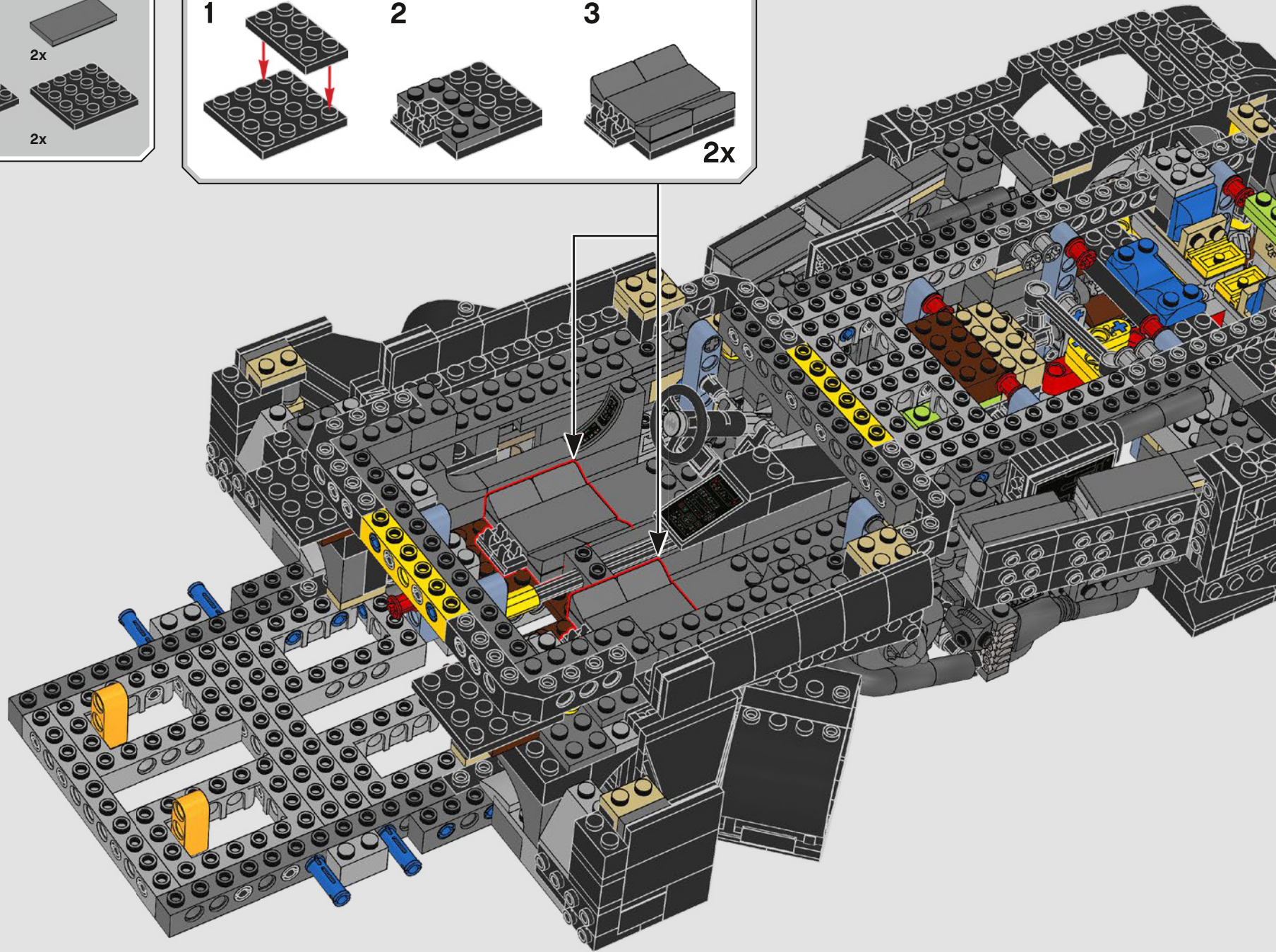
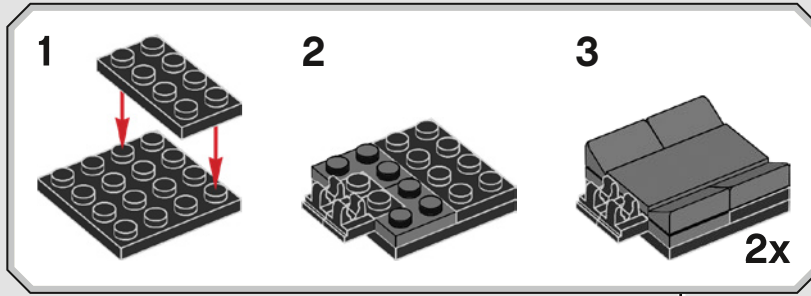

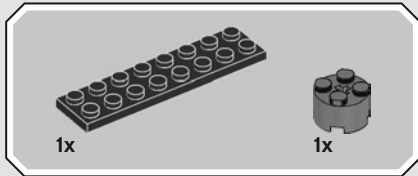
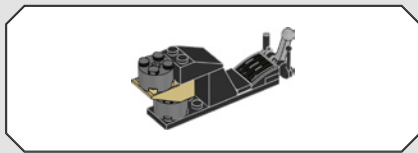

310

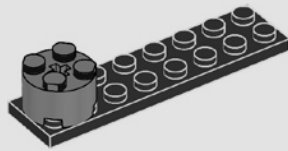

311

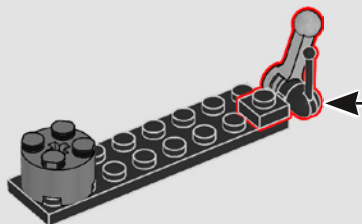
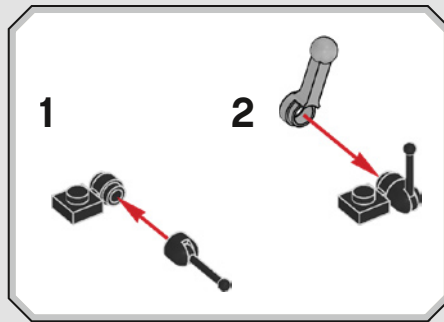

312

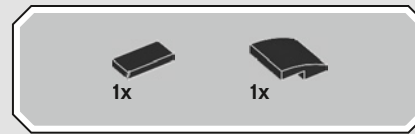
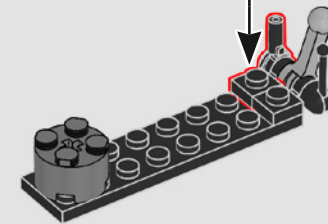
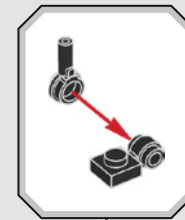

313

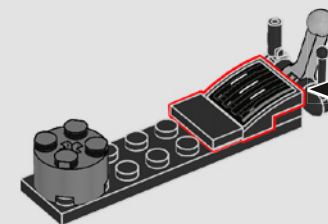
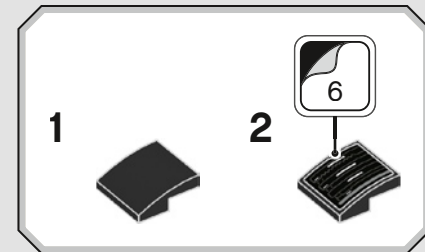

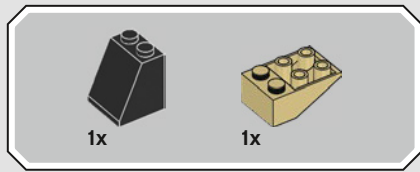

314

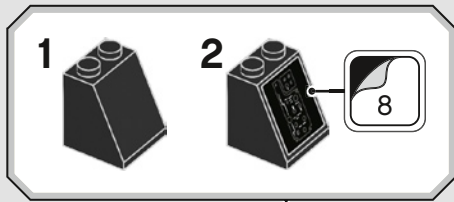
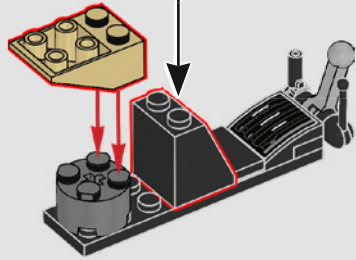

315

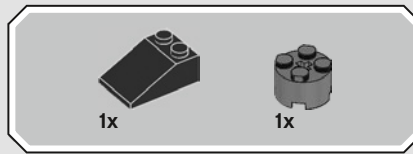
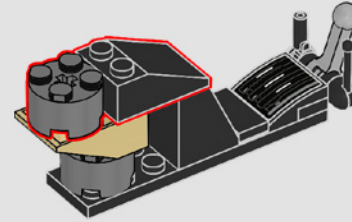

316

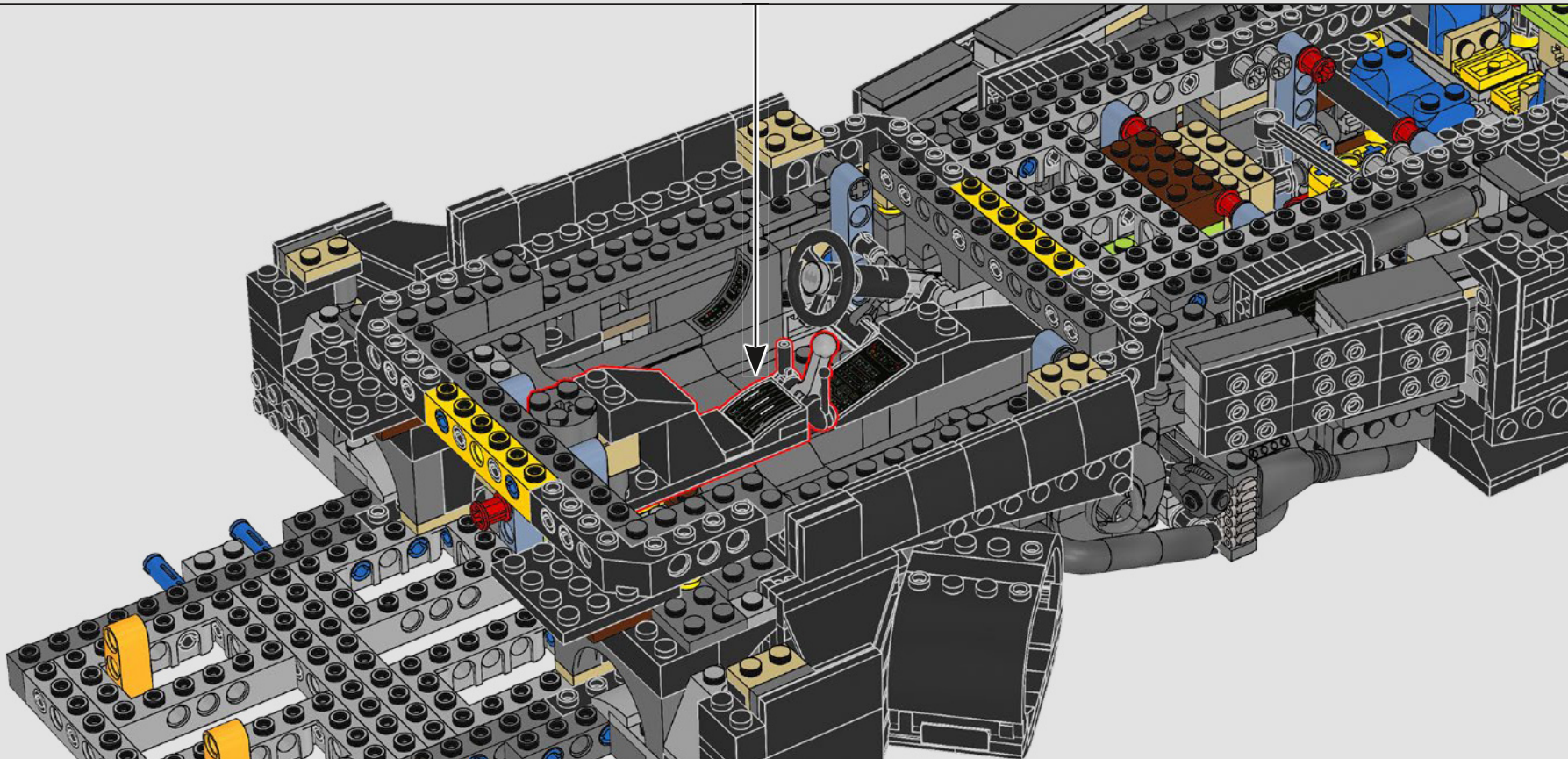

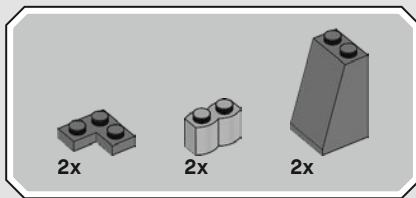

317

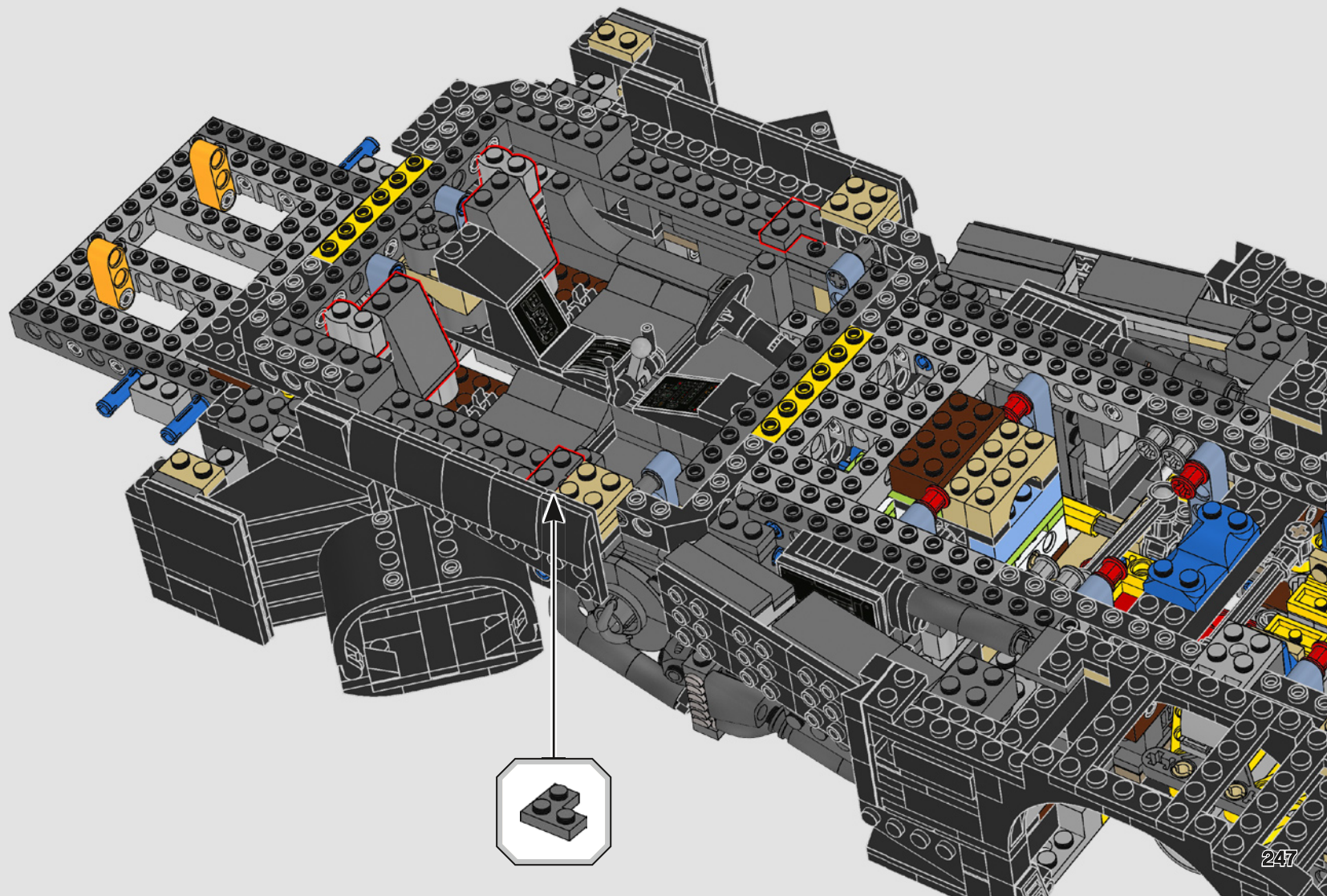

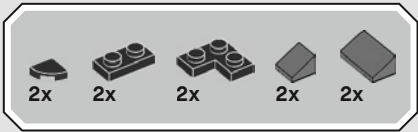

# 318

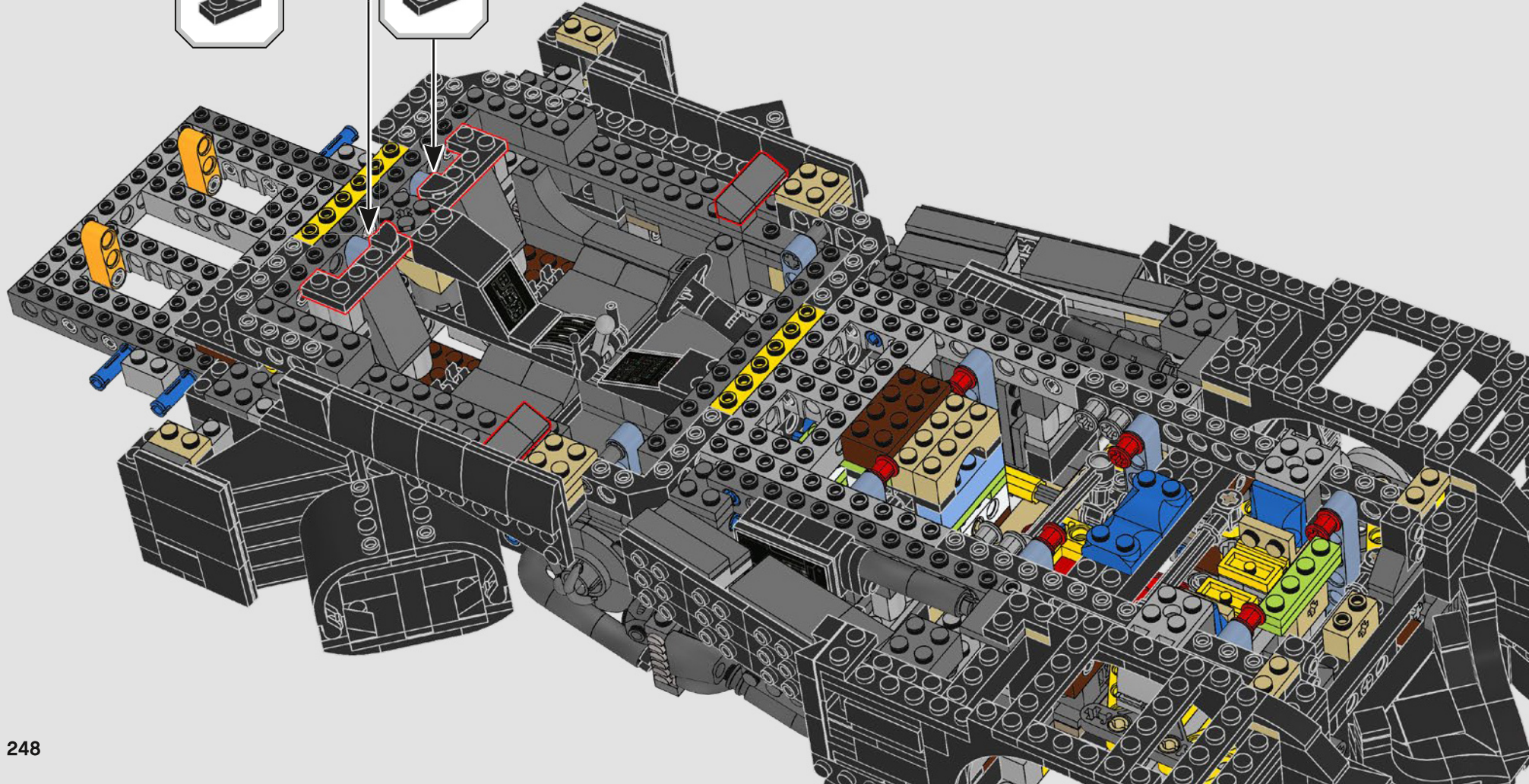
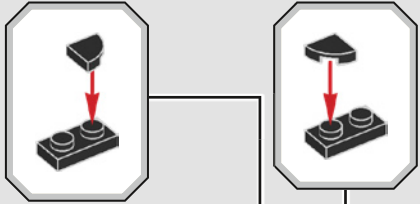



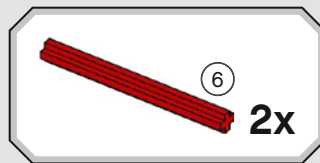
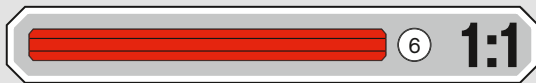
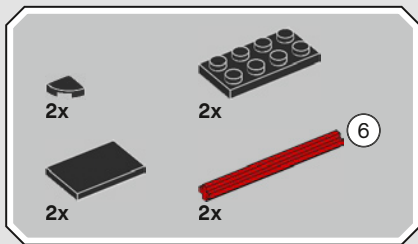

319

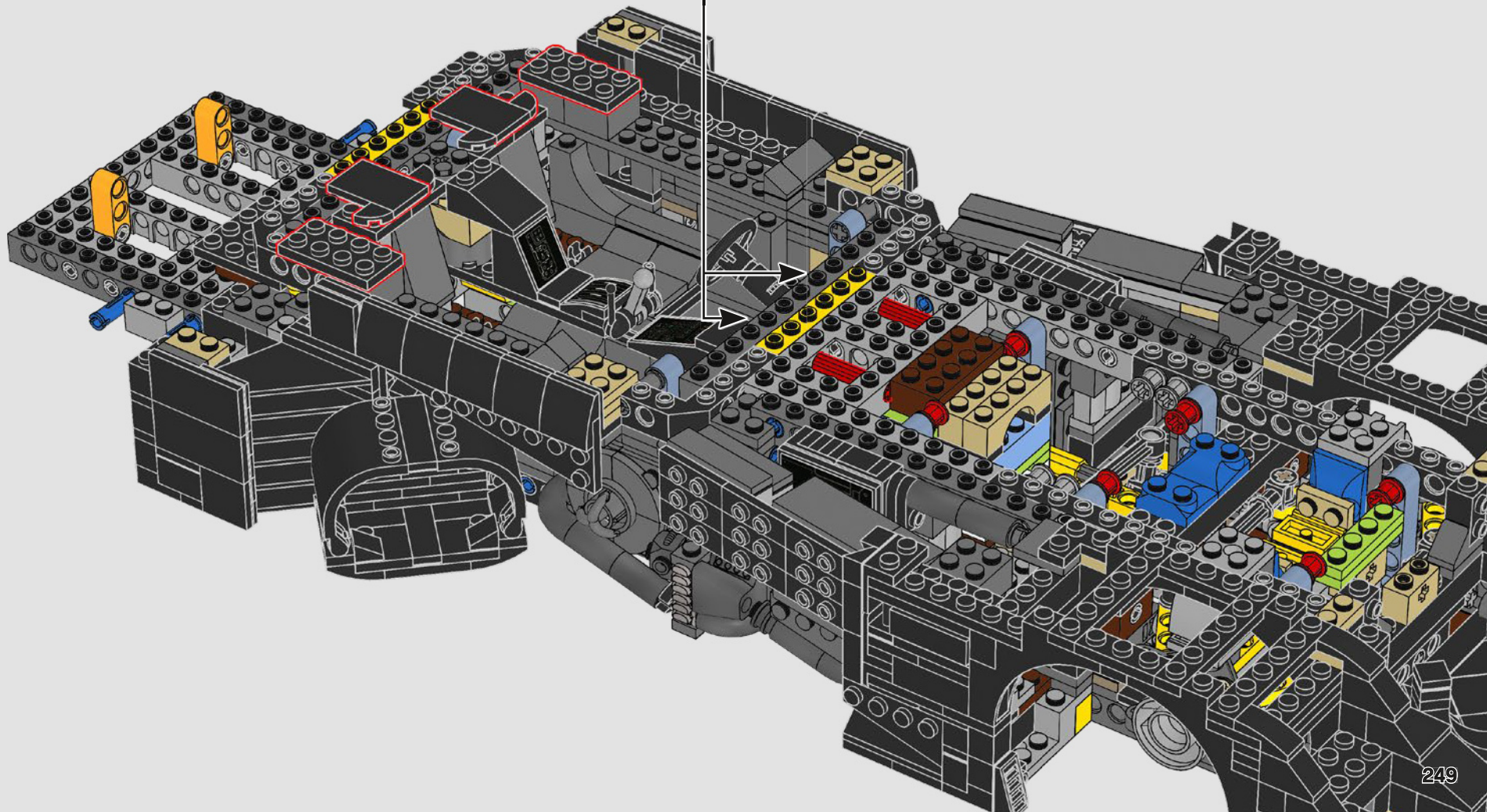

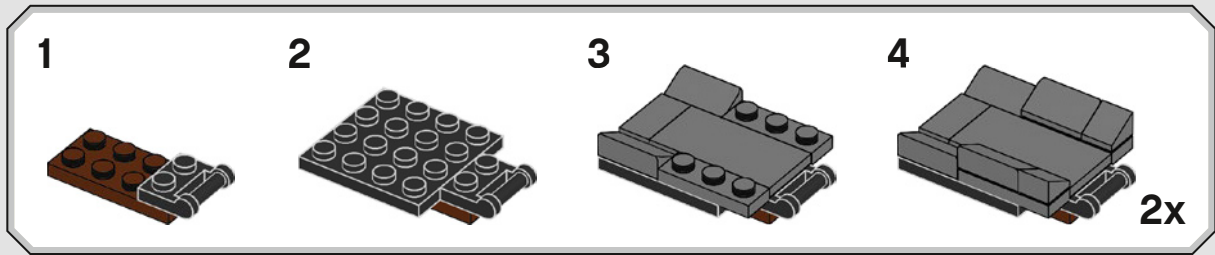
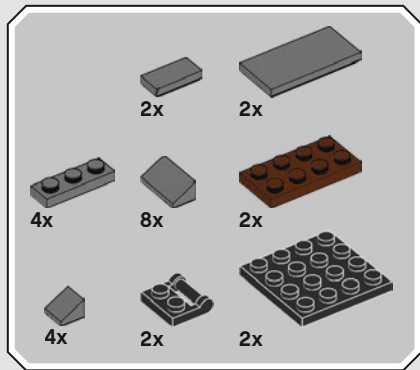

320

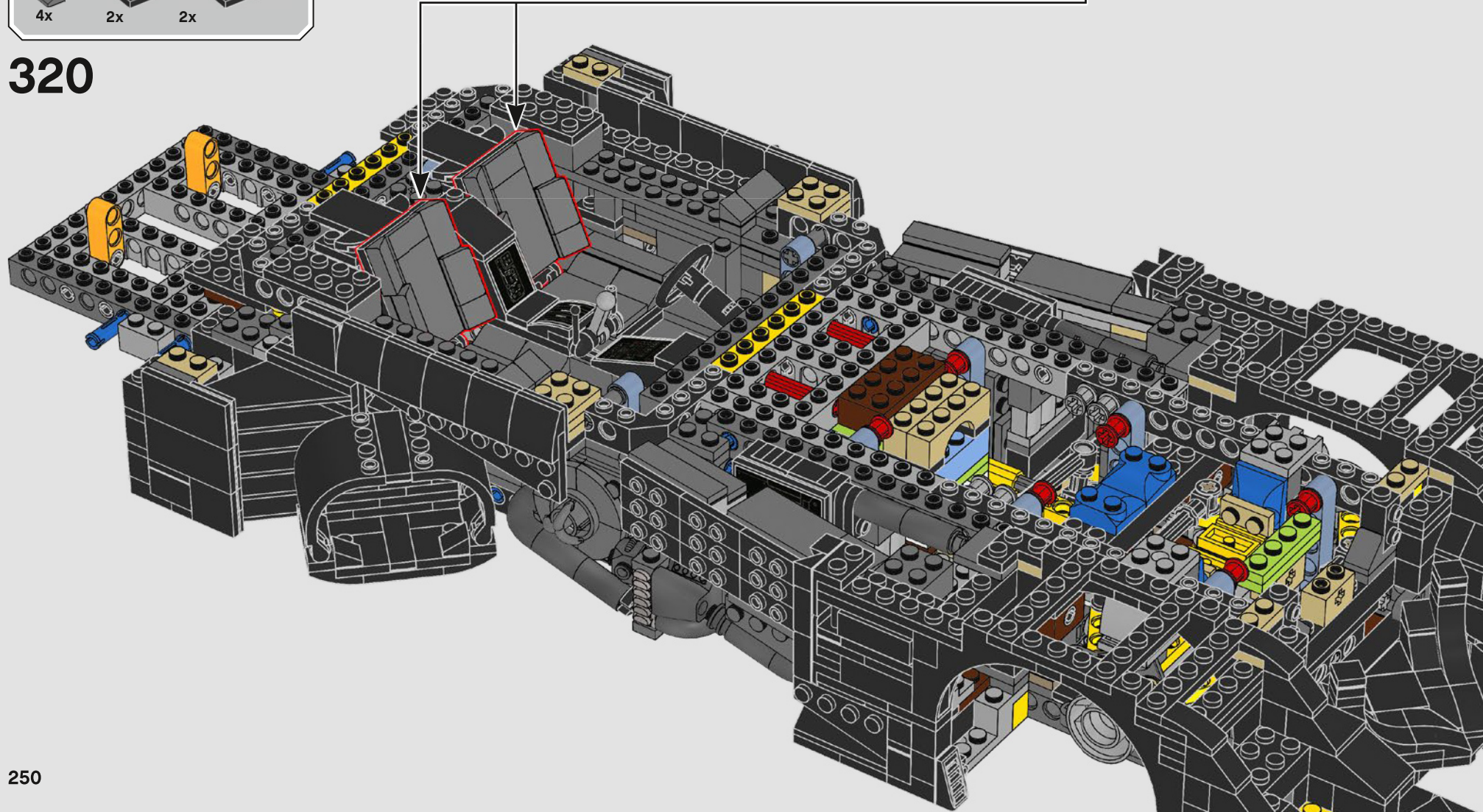

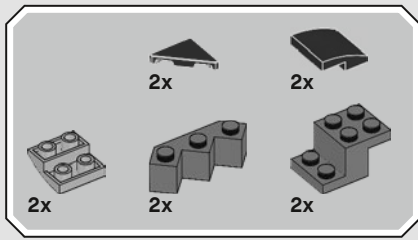

321

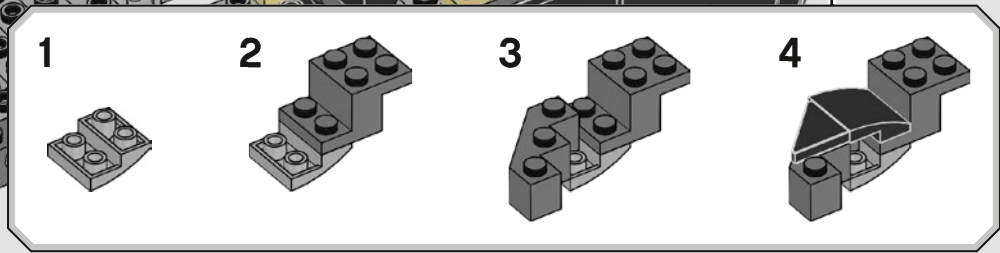
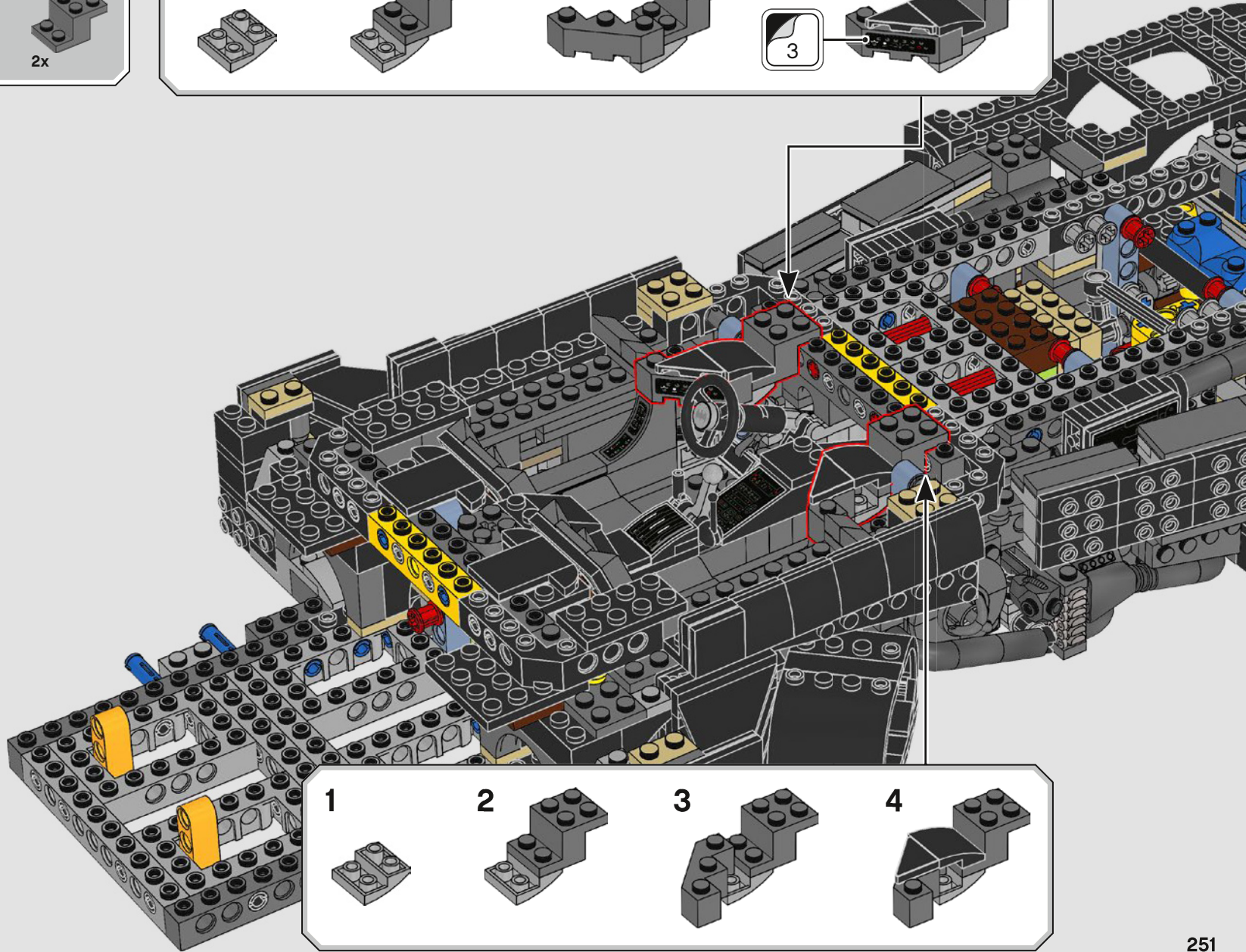
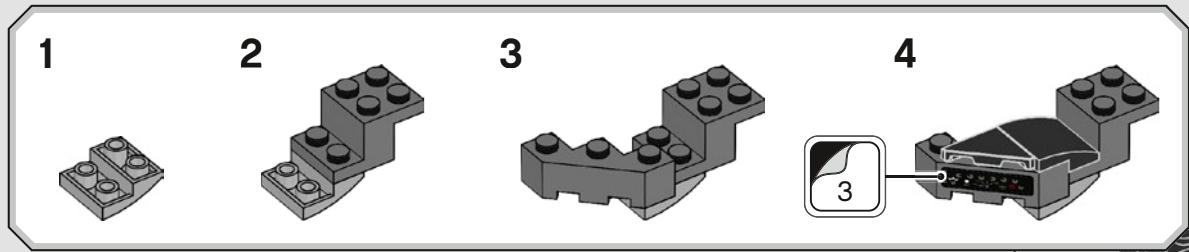

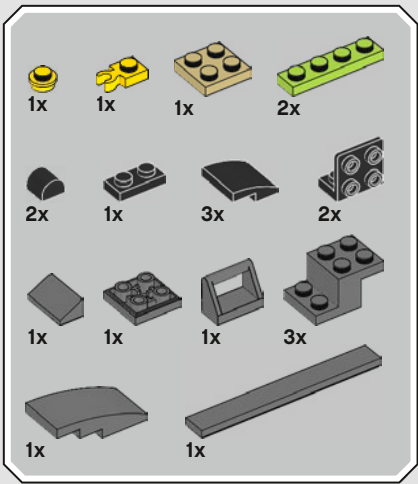

# 322

1

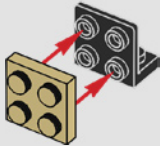

2

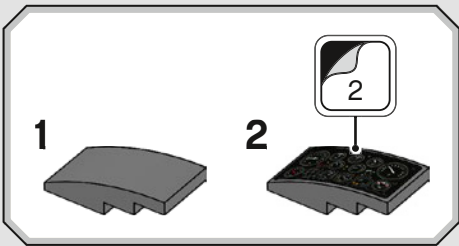
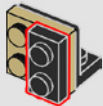

3



4

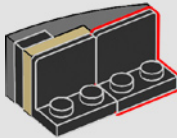

5

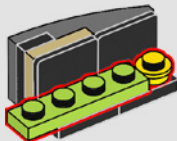

6

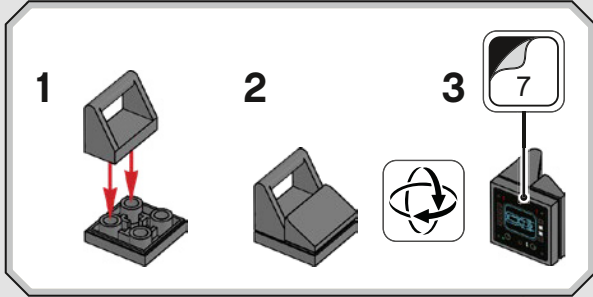
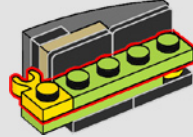

7



8

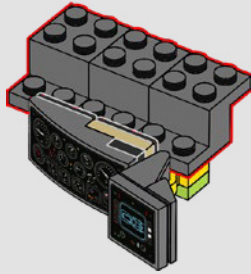

9

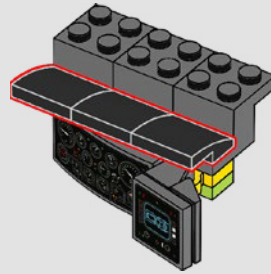

10

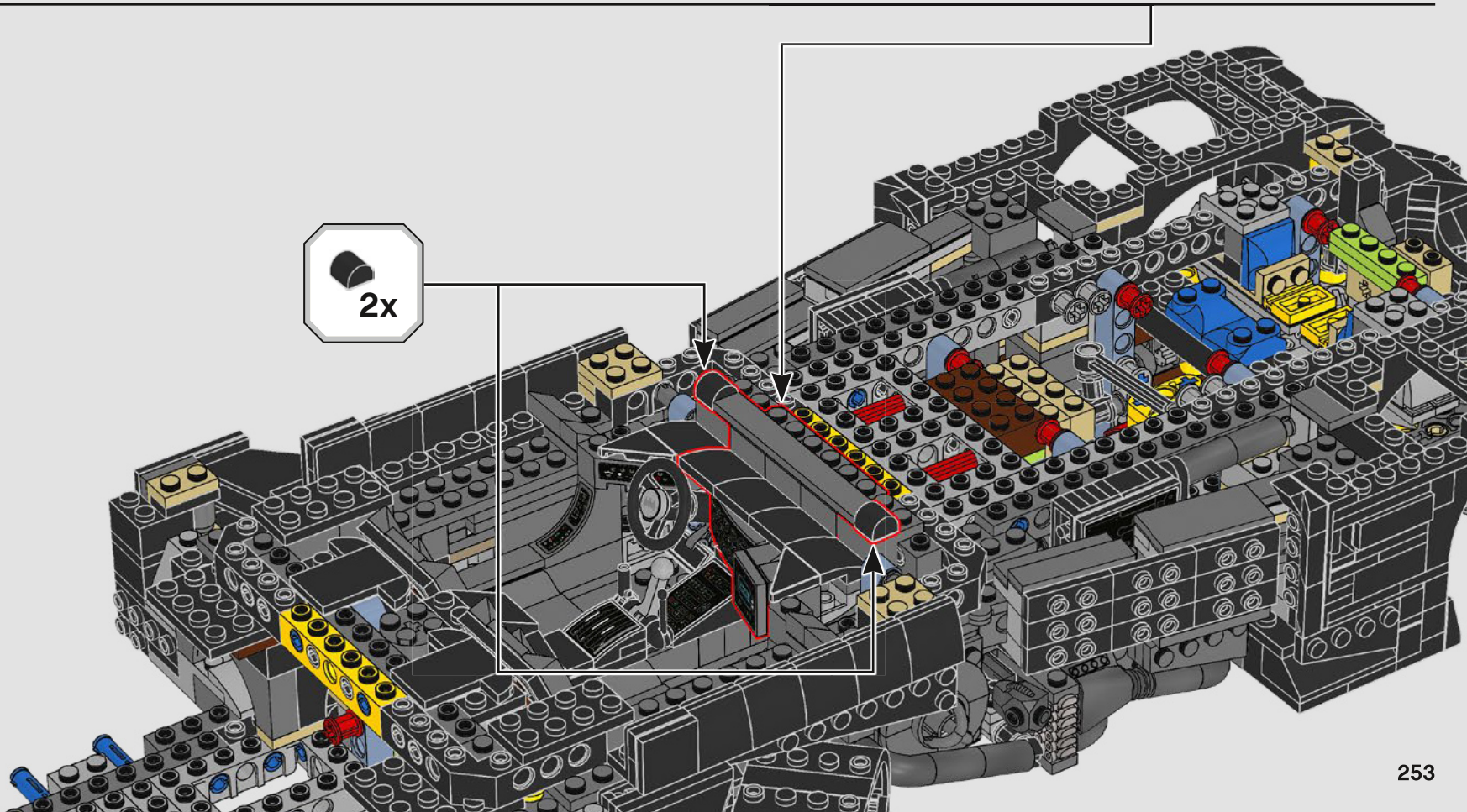
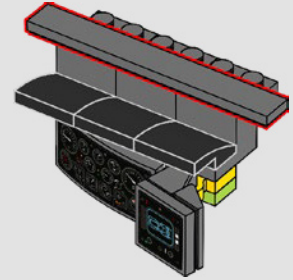

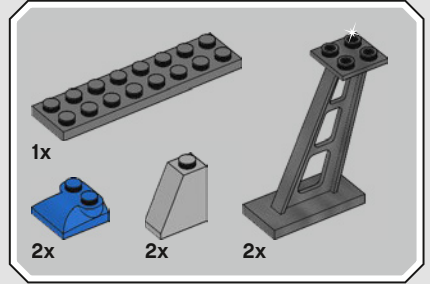
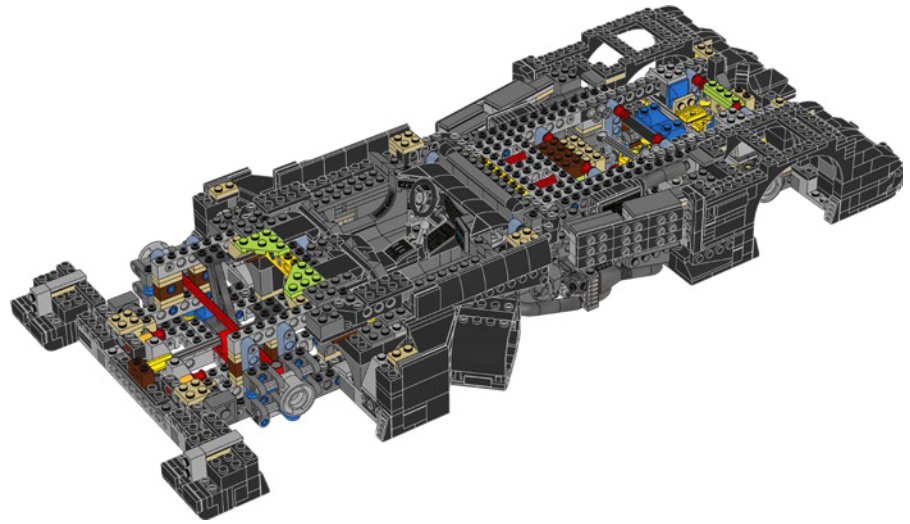
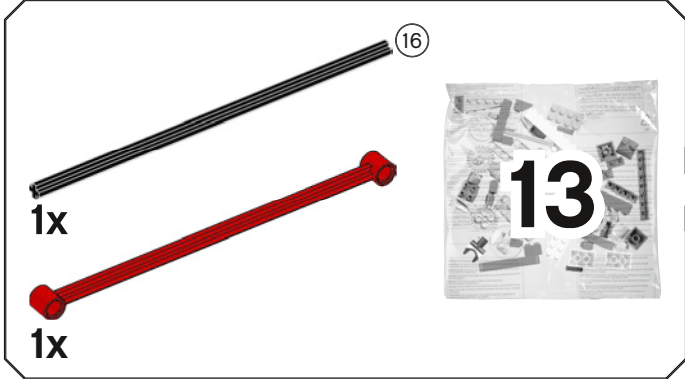

323

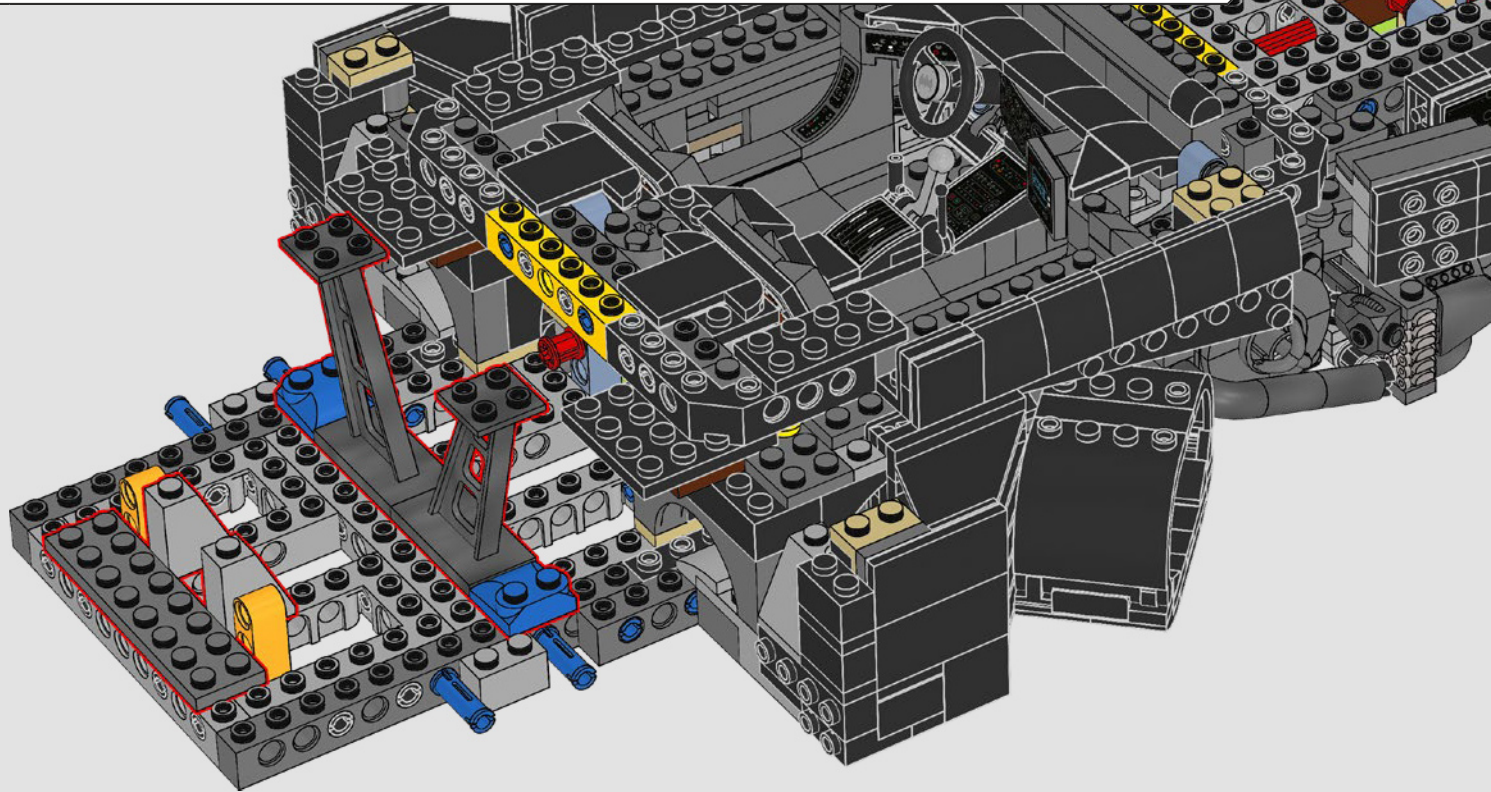

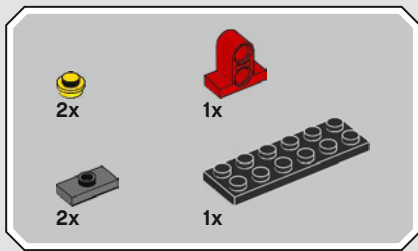

324

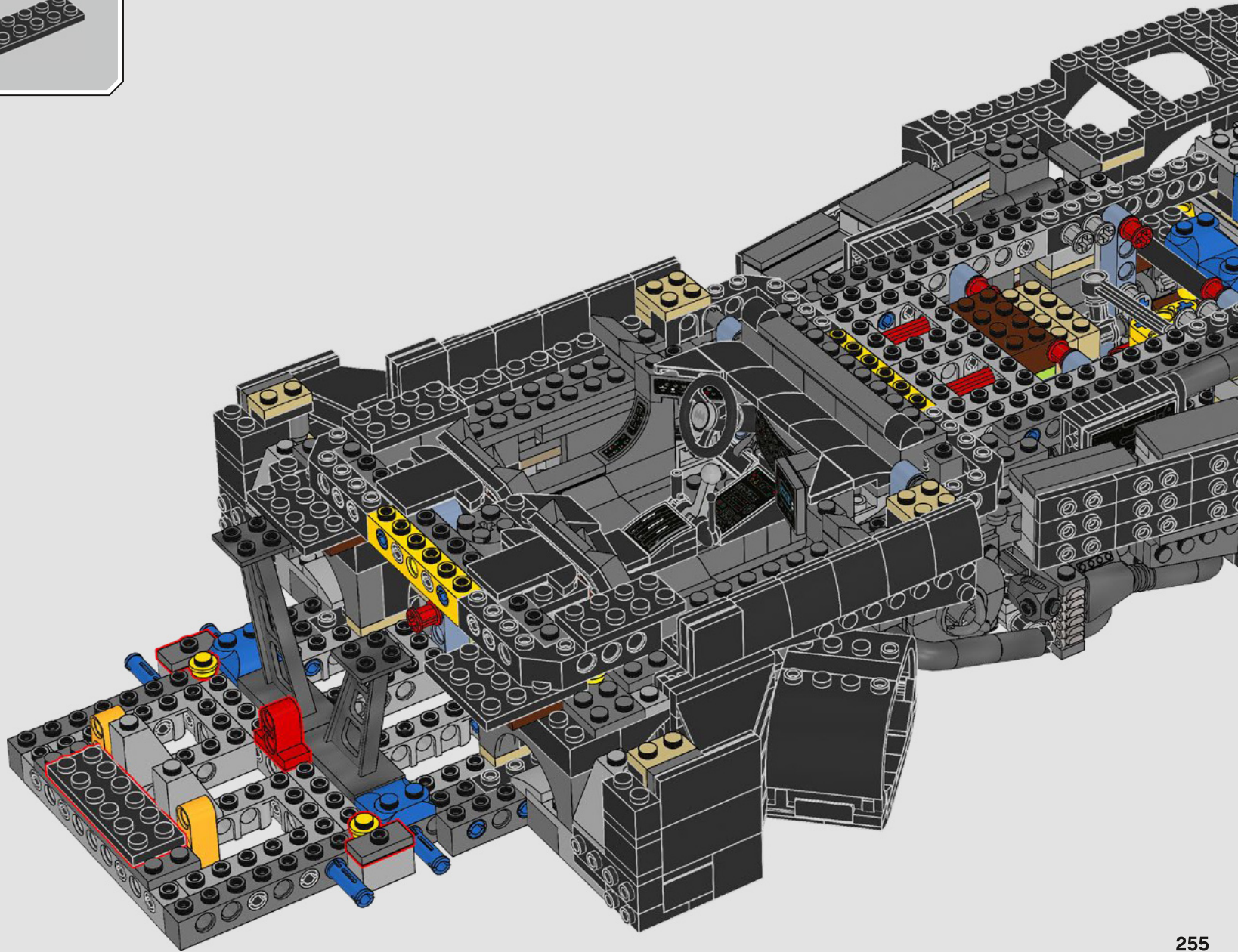

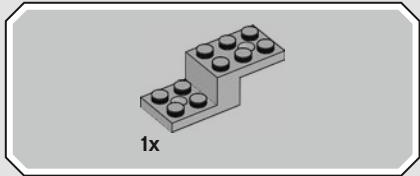
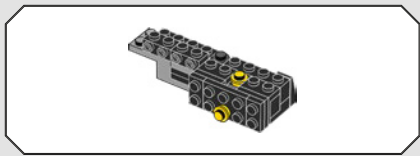

**325**

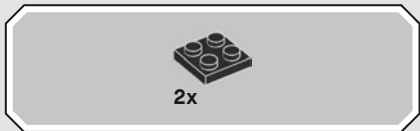
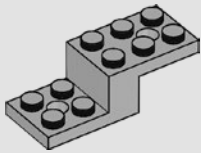

**326**

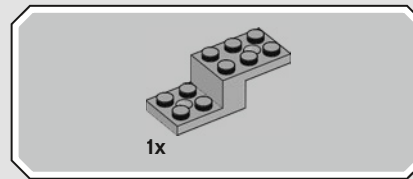
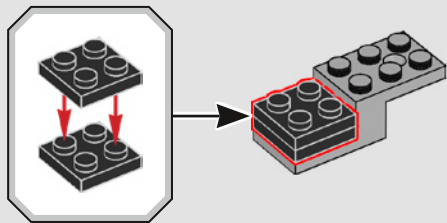

**327**

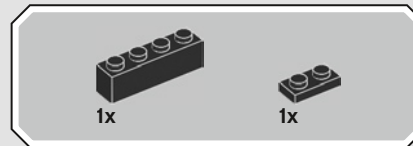
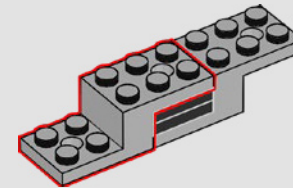

**328**

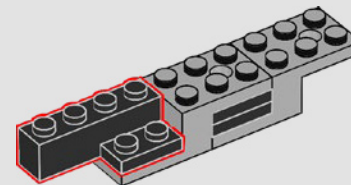



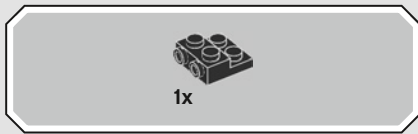

329

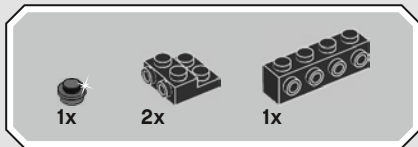
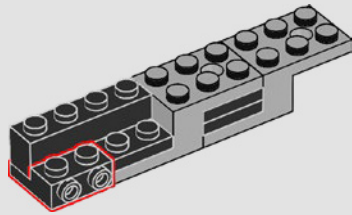

330

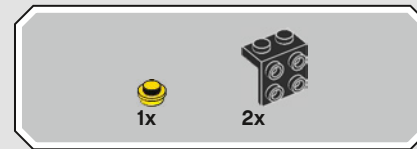
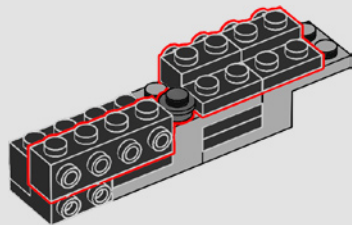

331

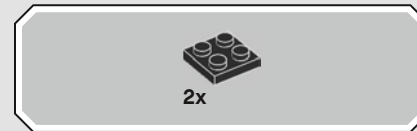
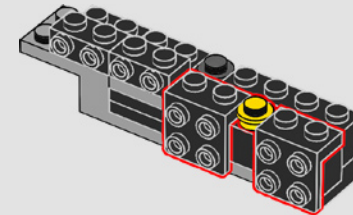

332

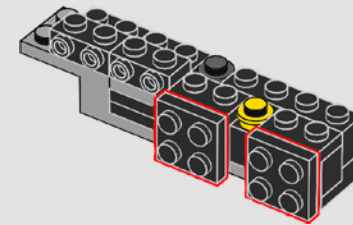

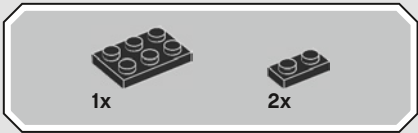

333

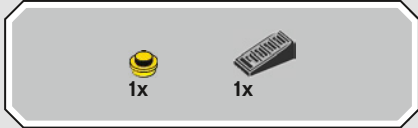
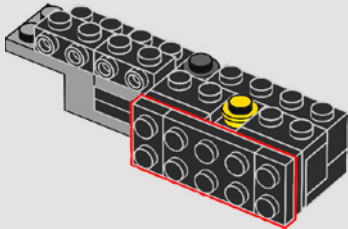

334

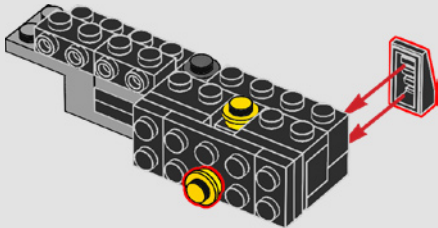

335

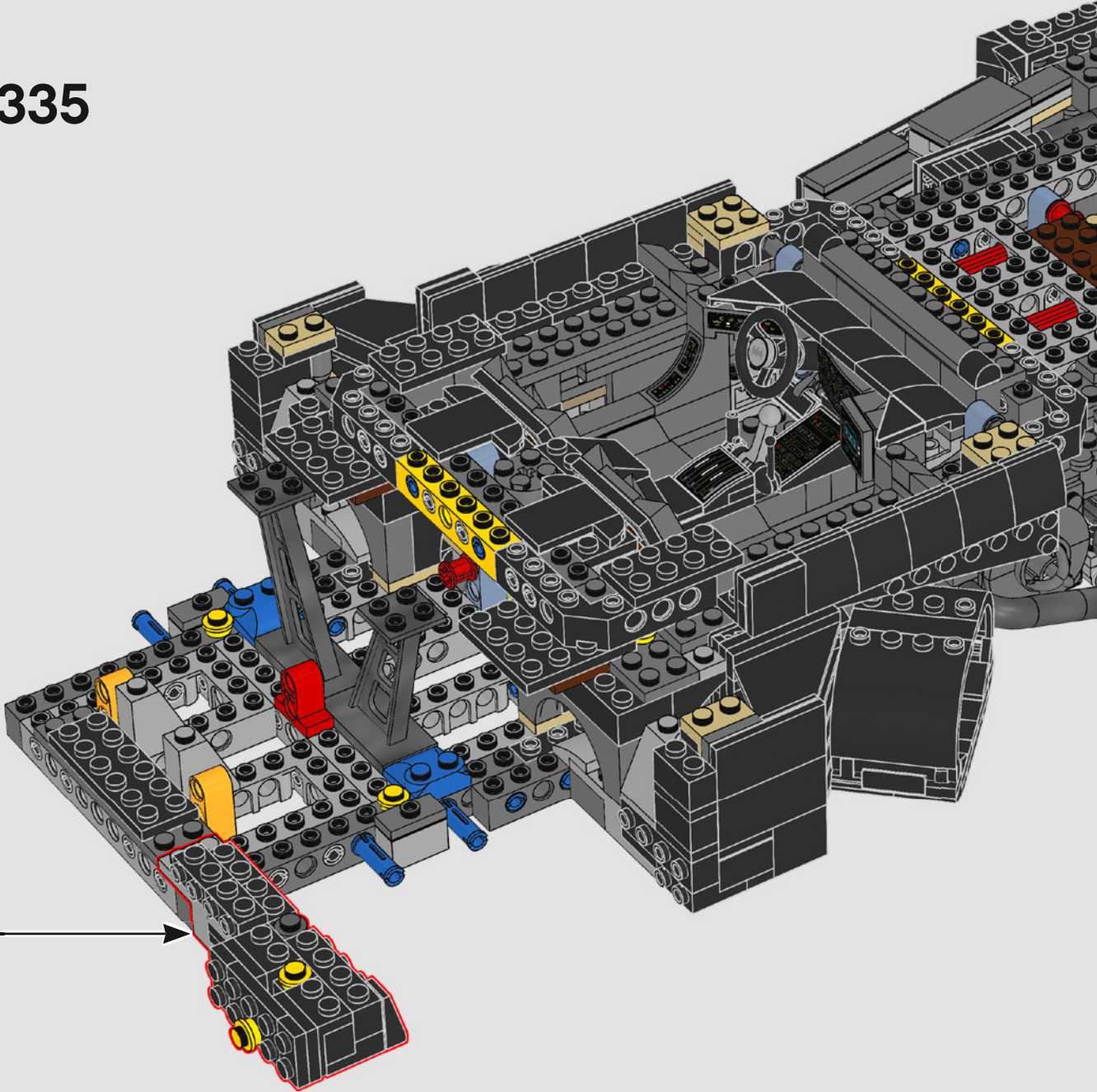

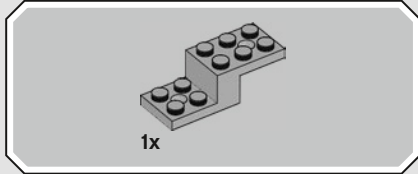
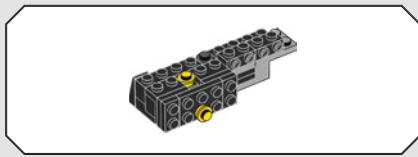

**336**

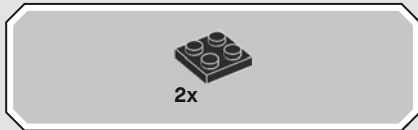
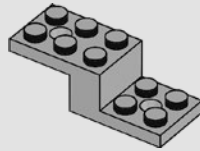

**337**

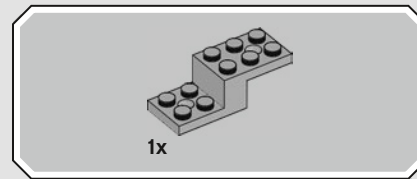
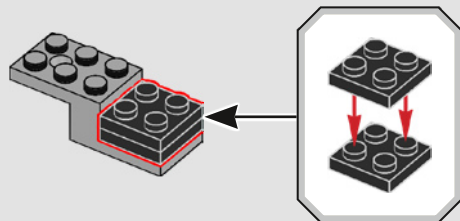

**338**

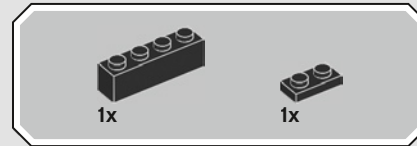
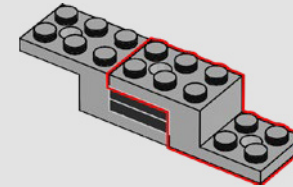

**339**

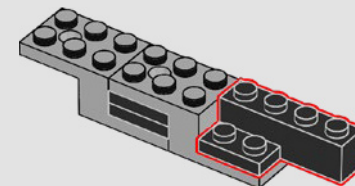

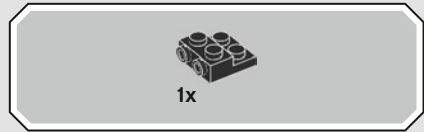

340

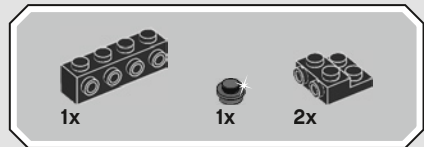
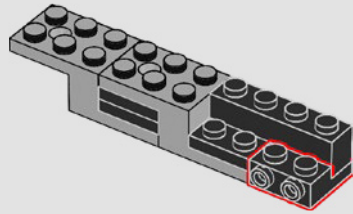

341

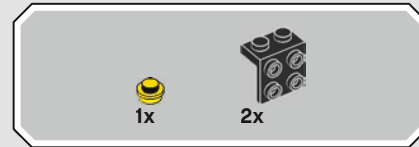
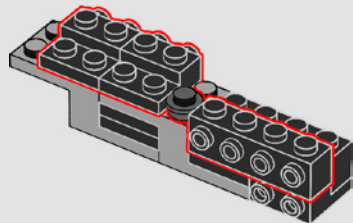

342

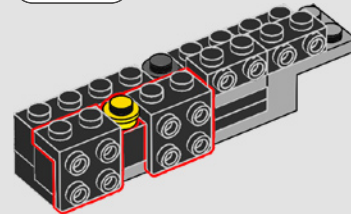

343

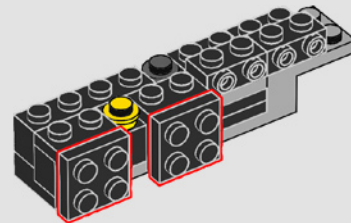



344

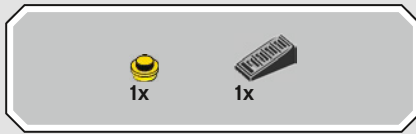
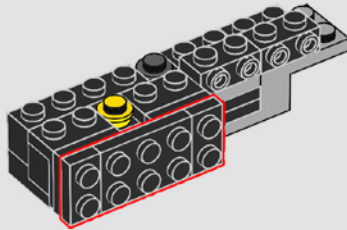

345

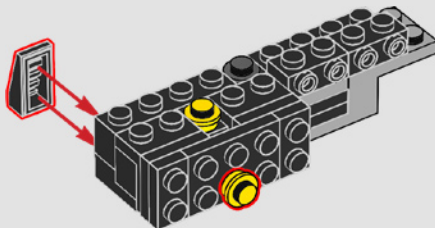

346

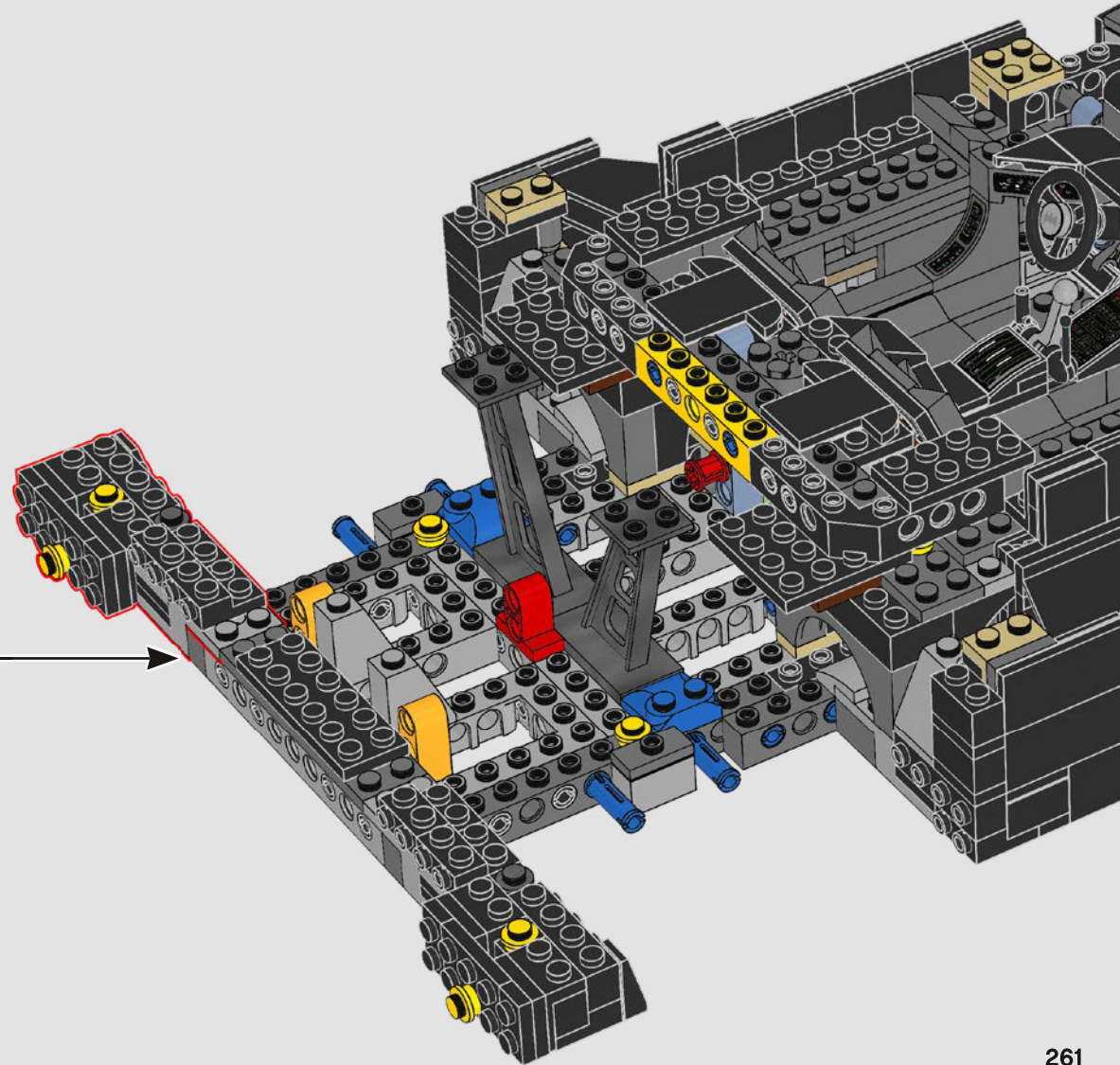

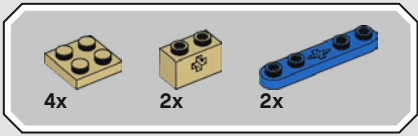

# 347

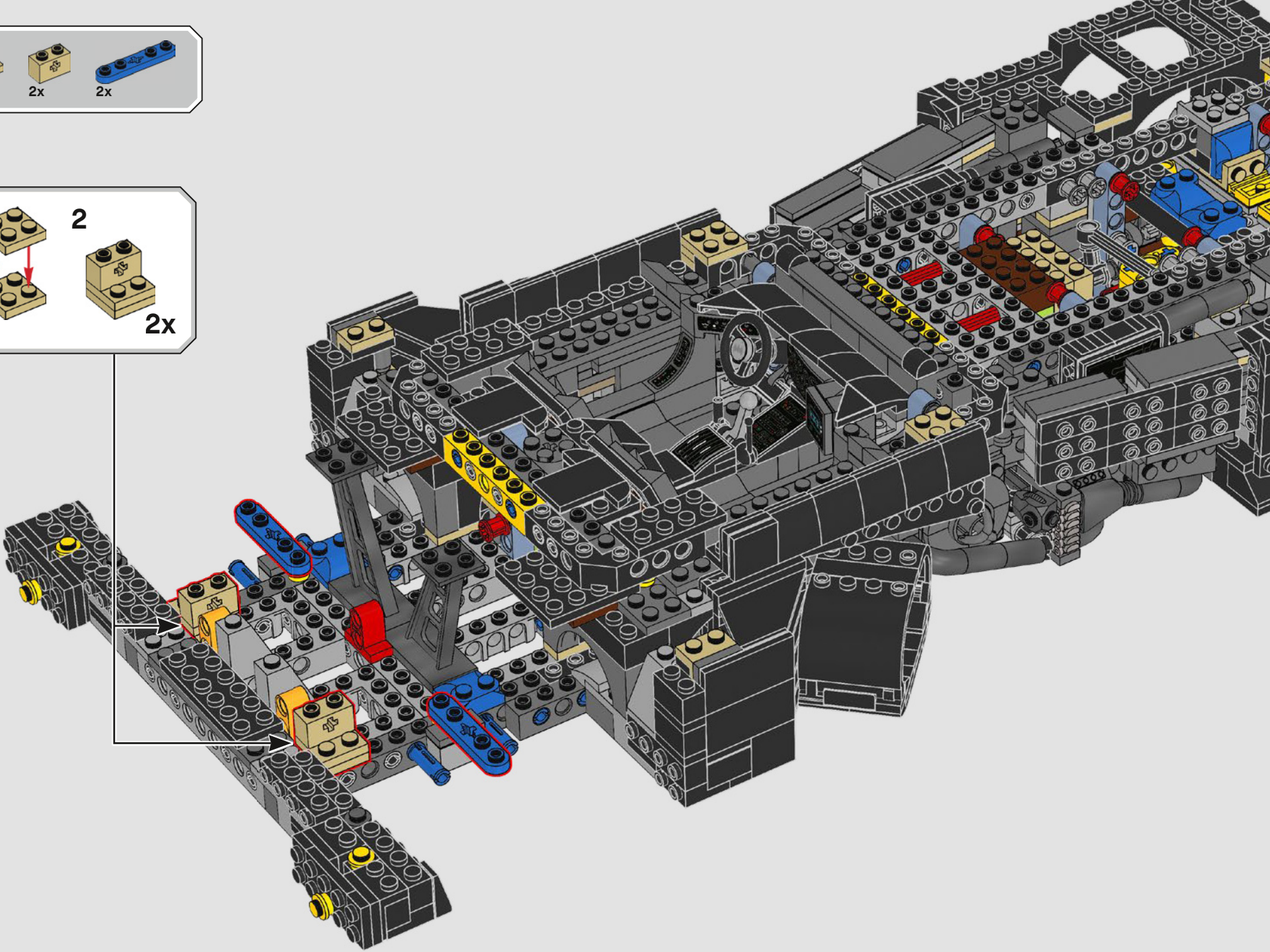
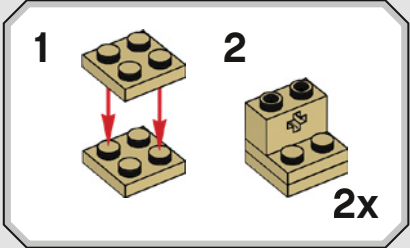

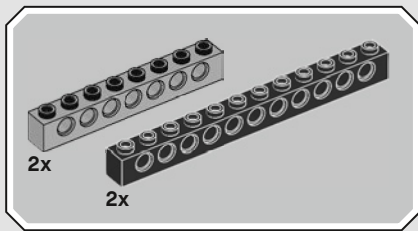

348

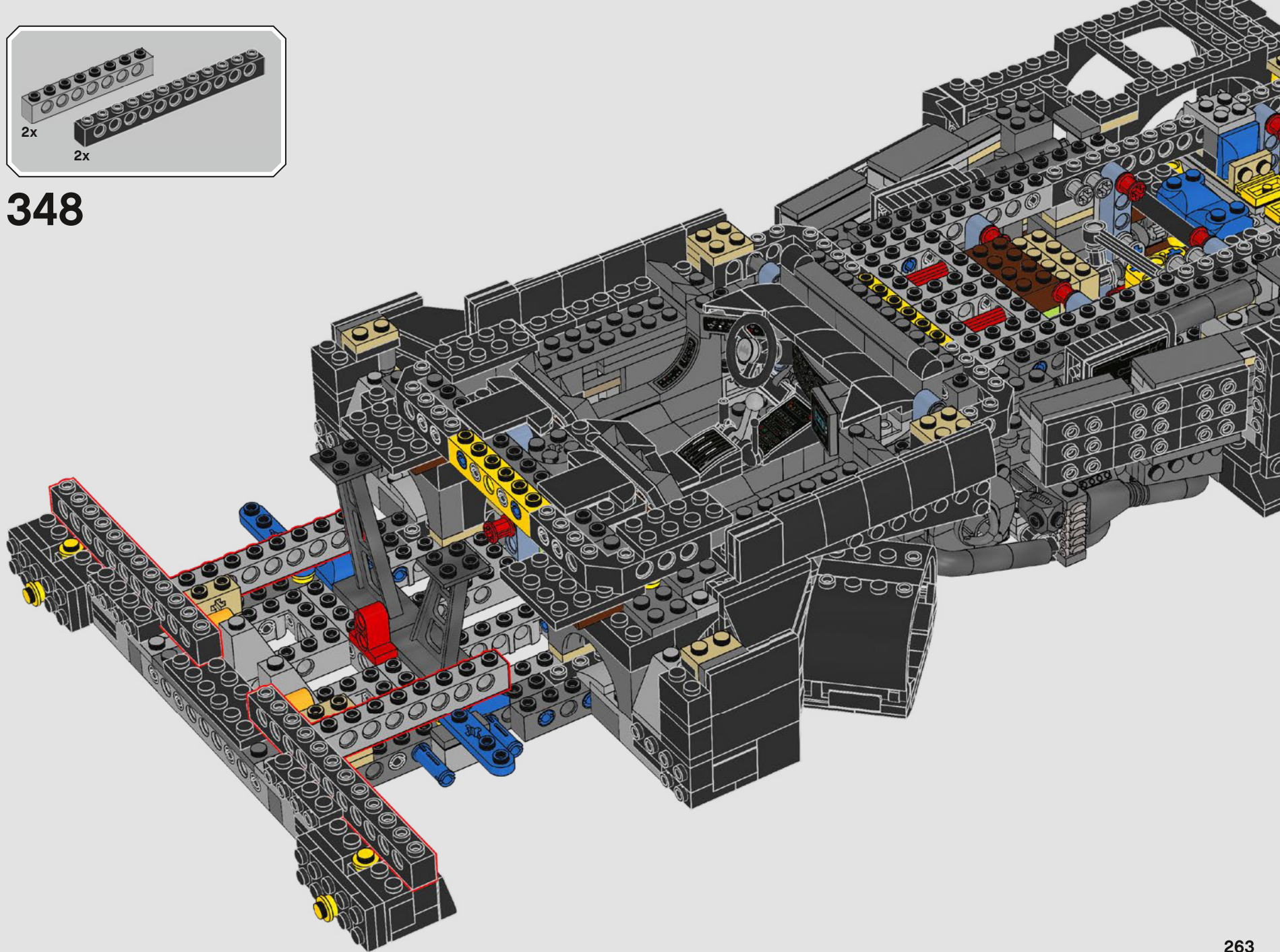

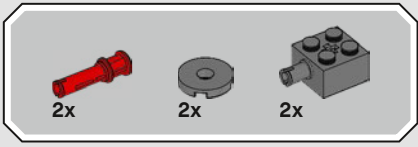

# 349

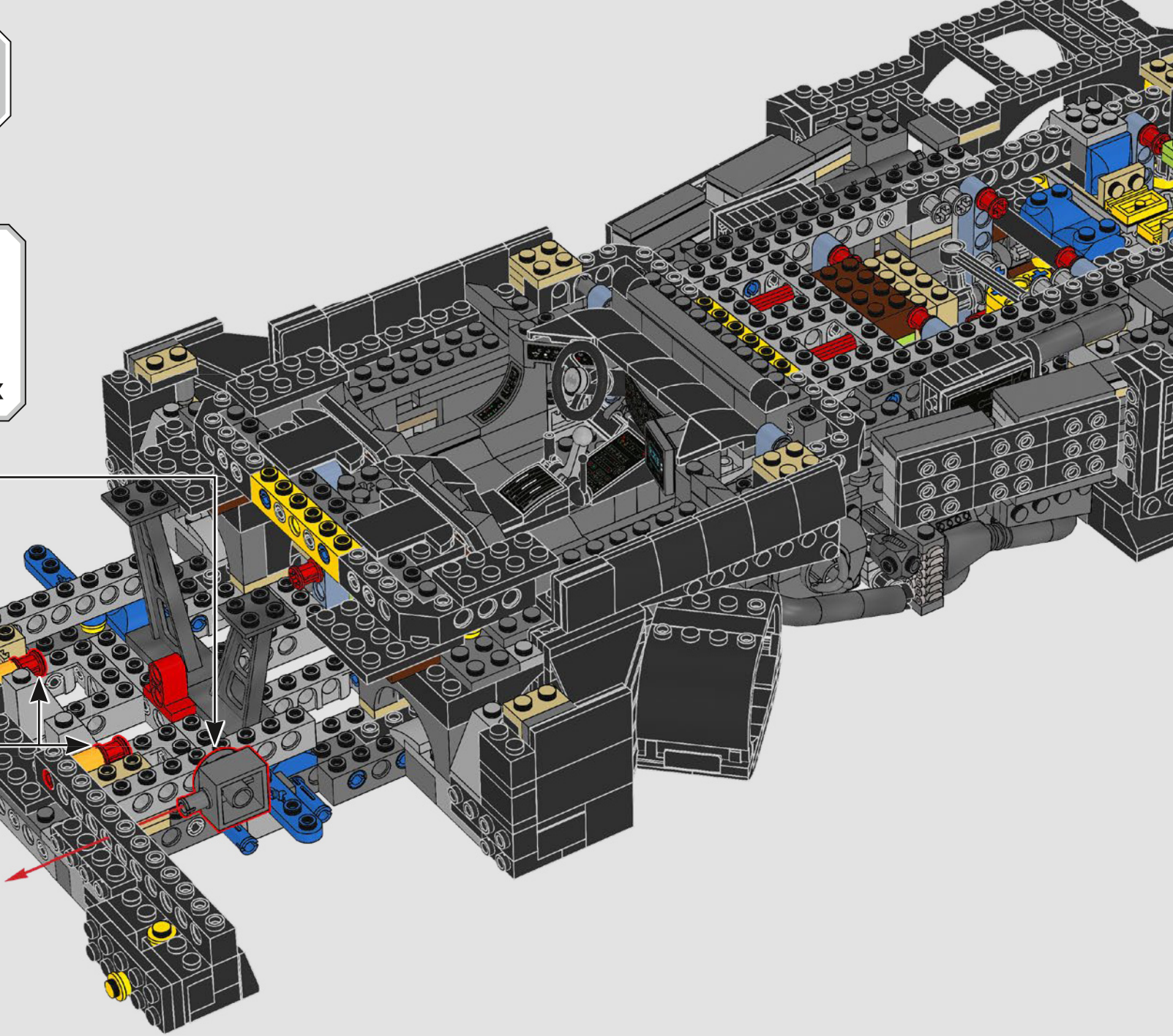
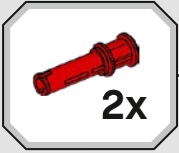
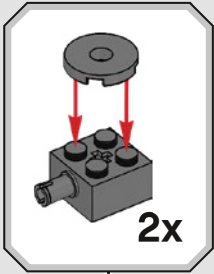



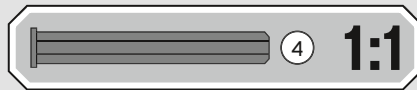
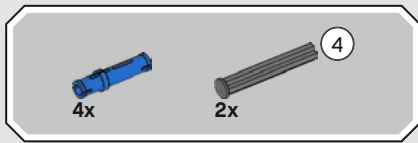

350

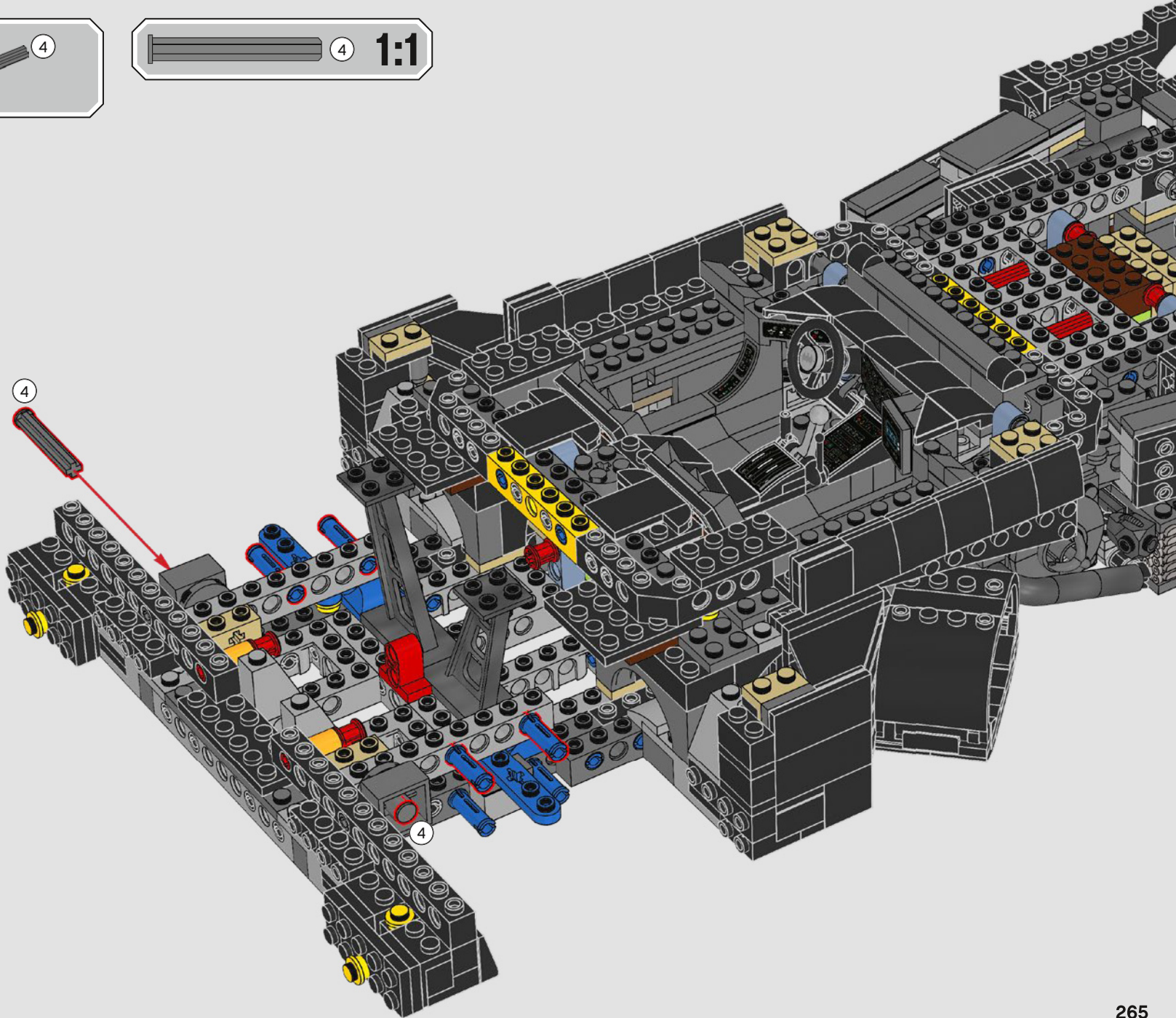

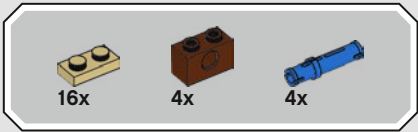

# 351

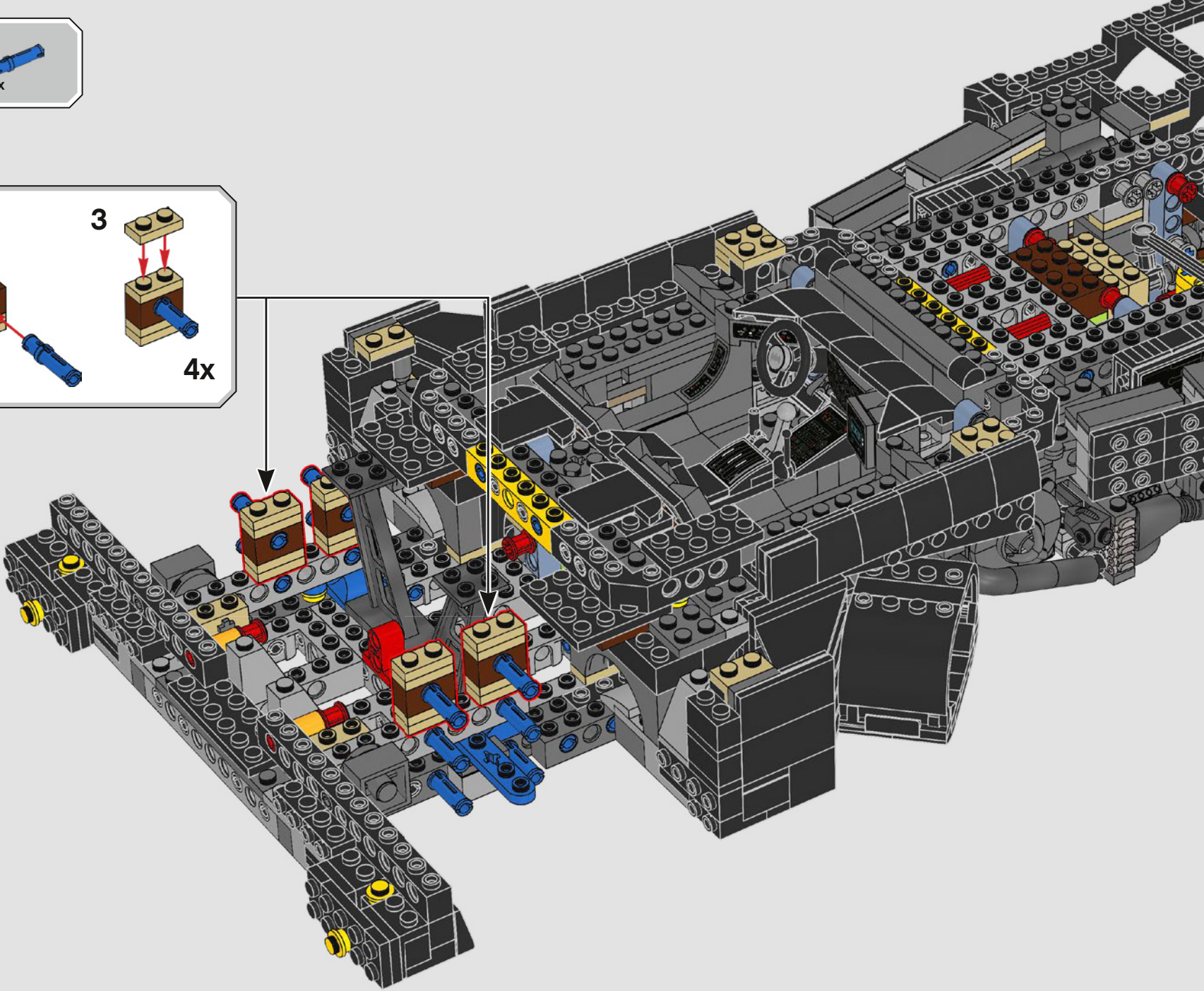
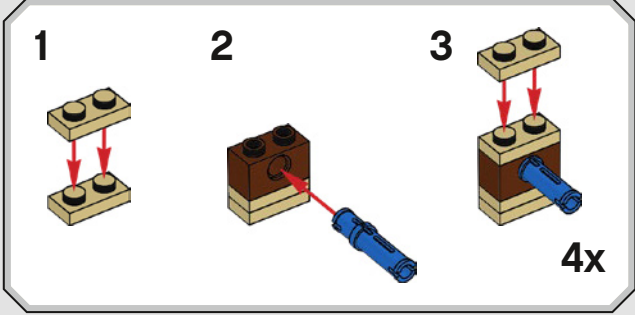

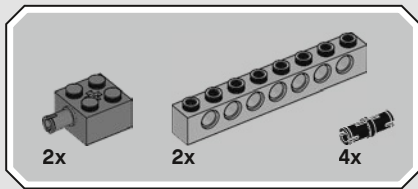

352

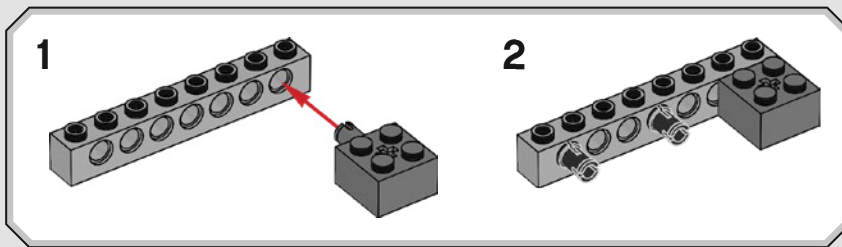
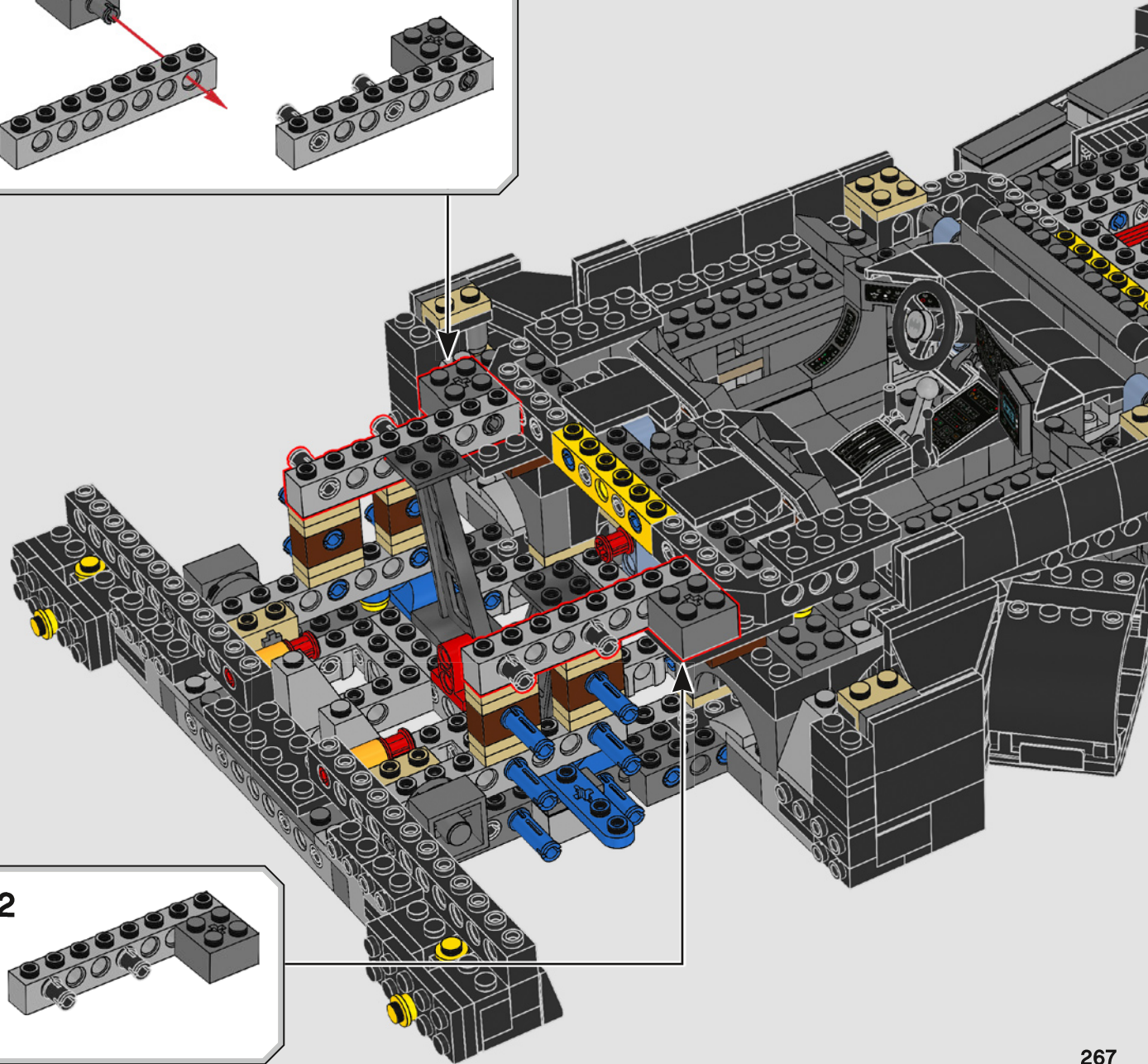
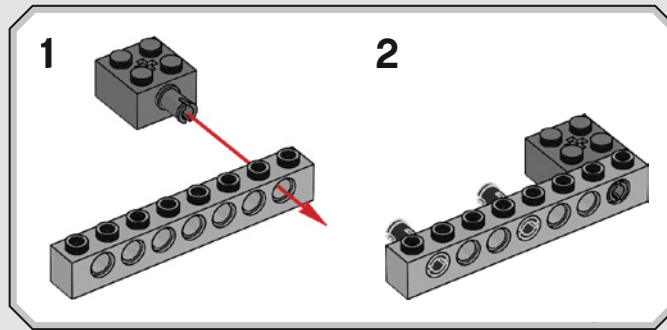

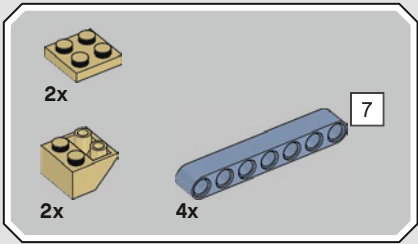

# 353

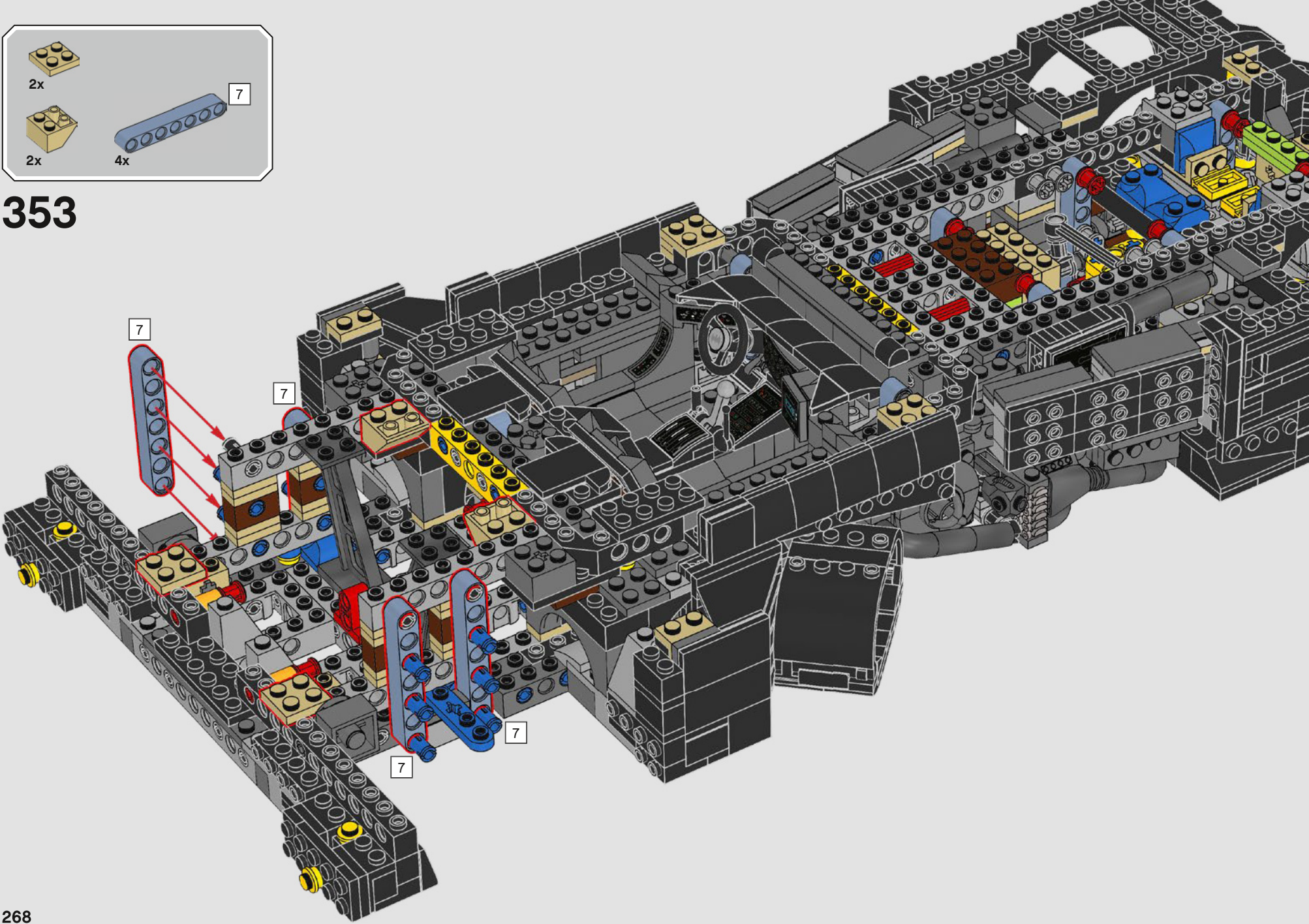

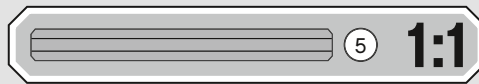
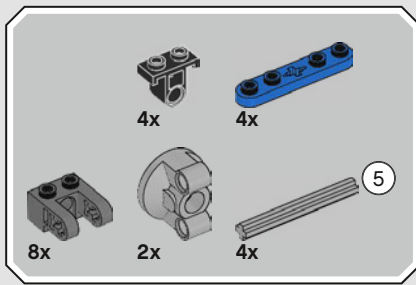

# 354

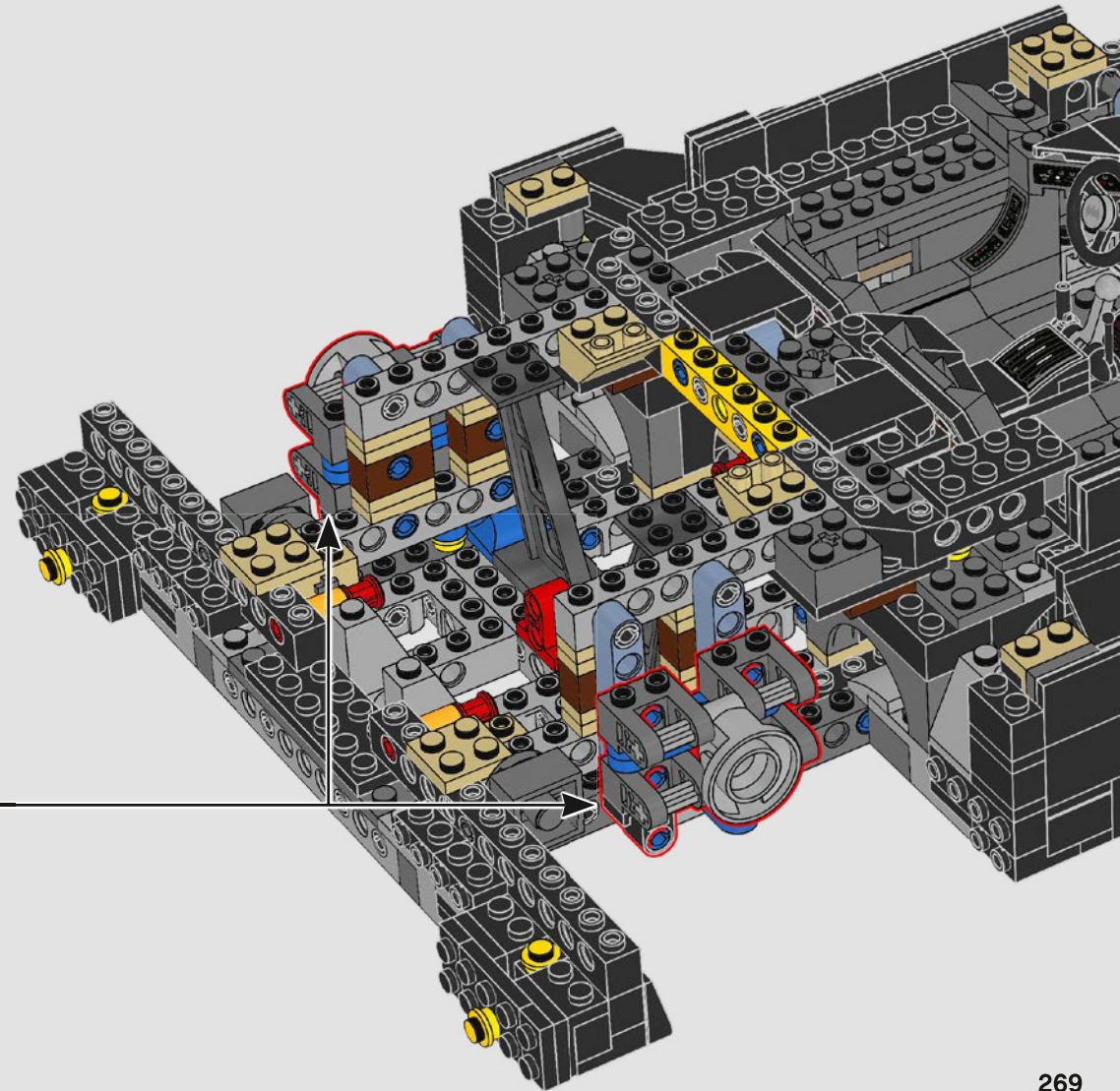
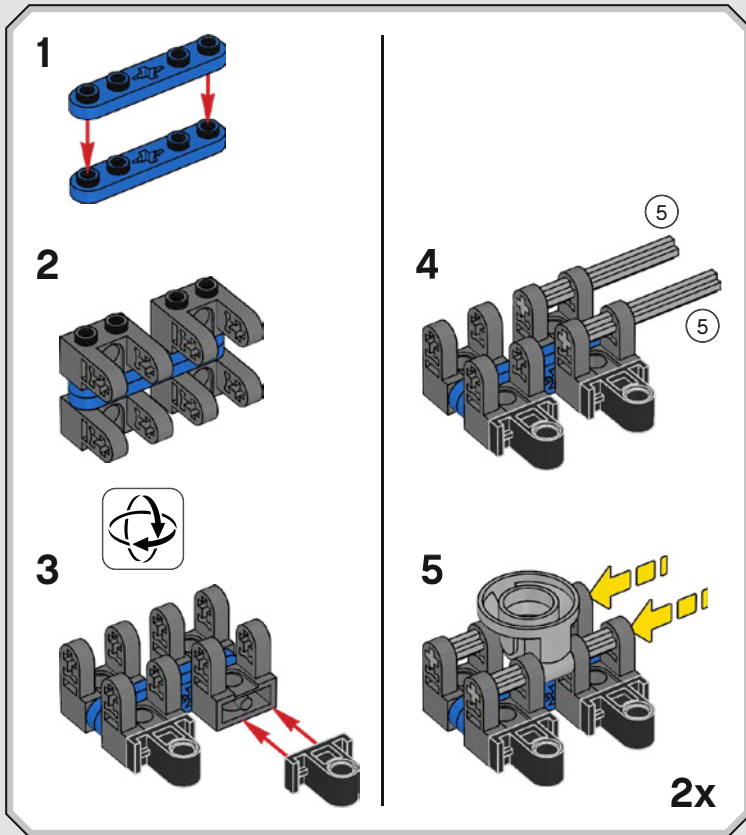

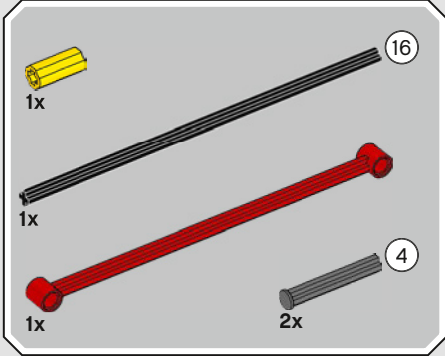

355

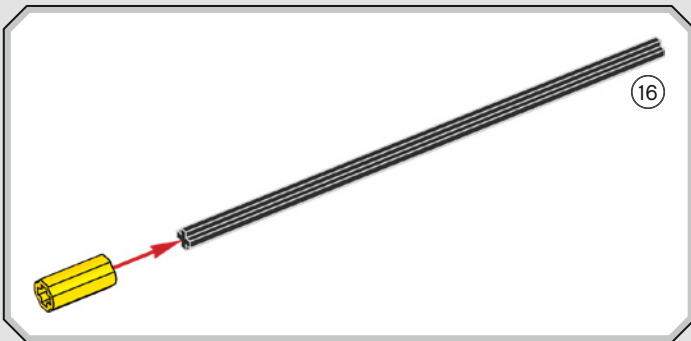
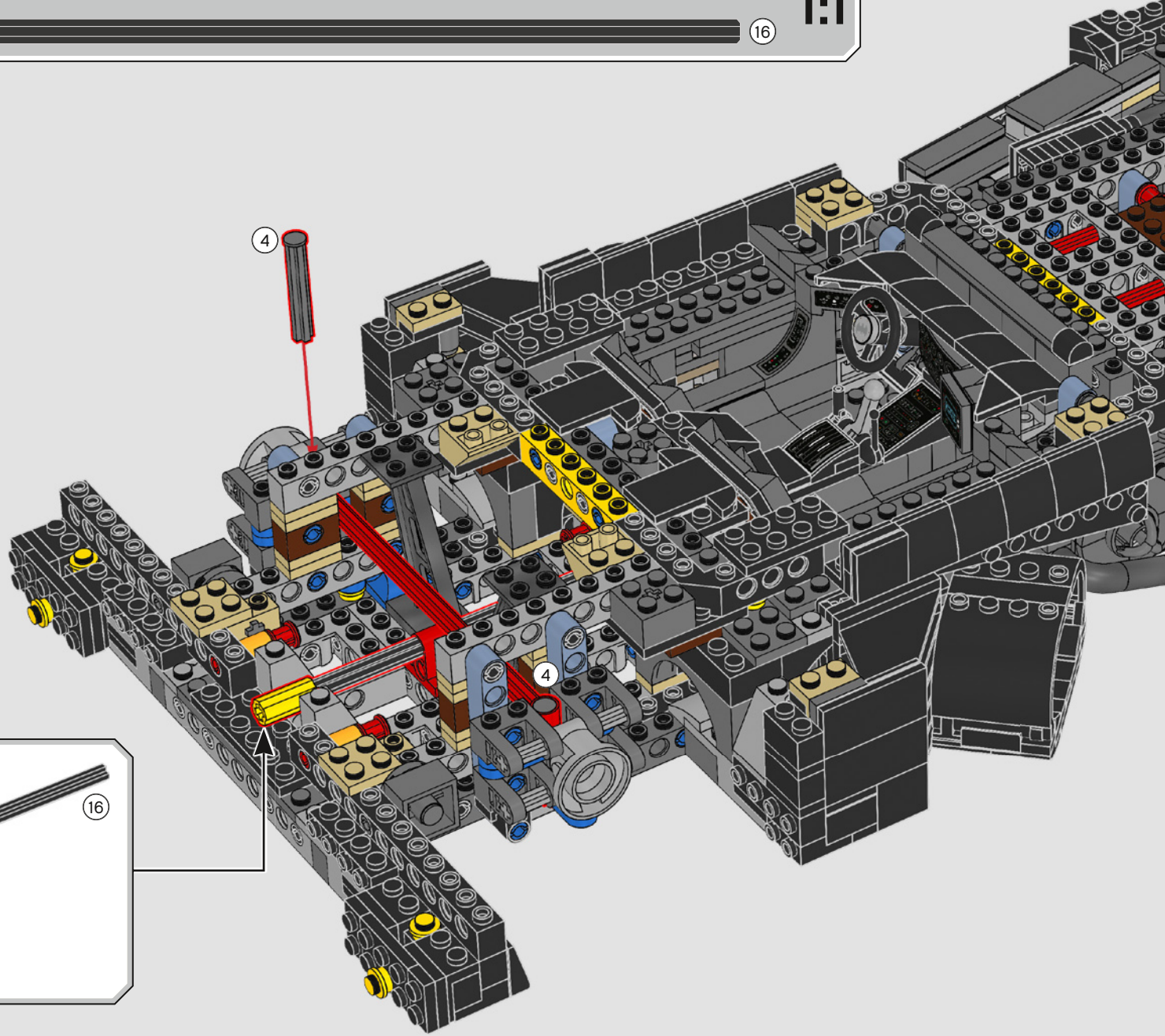

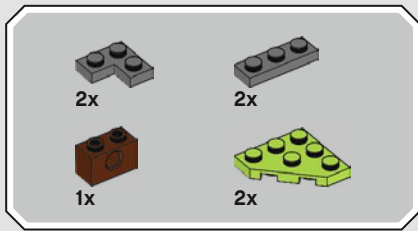

356

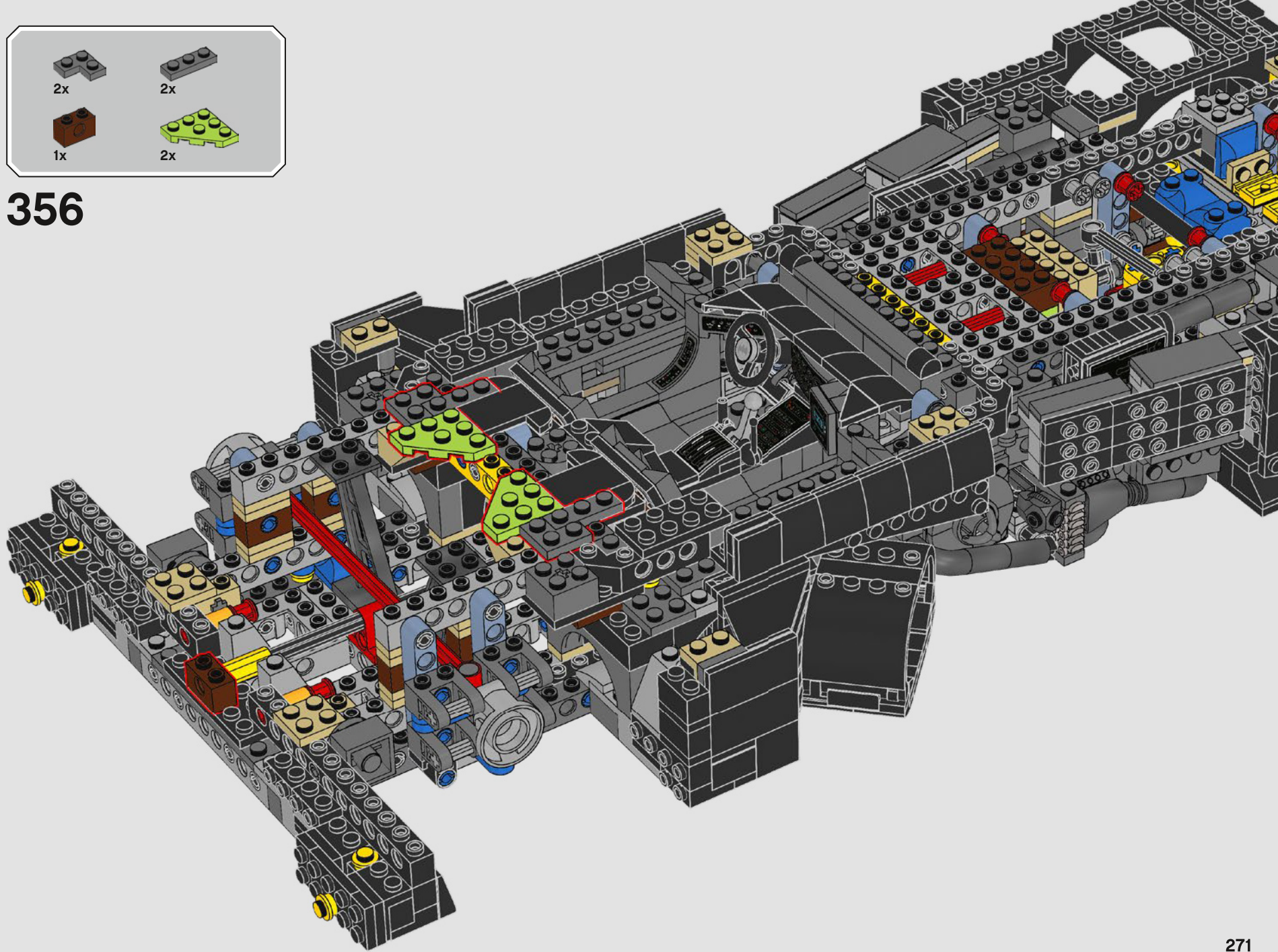

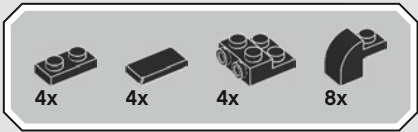

# 357

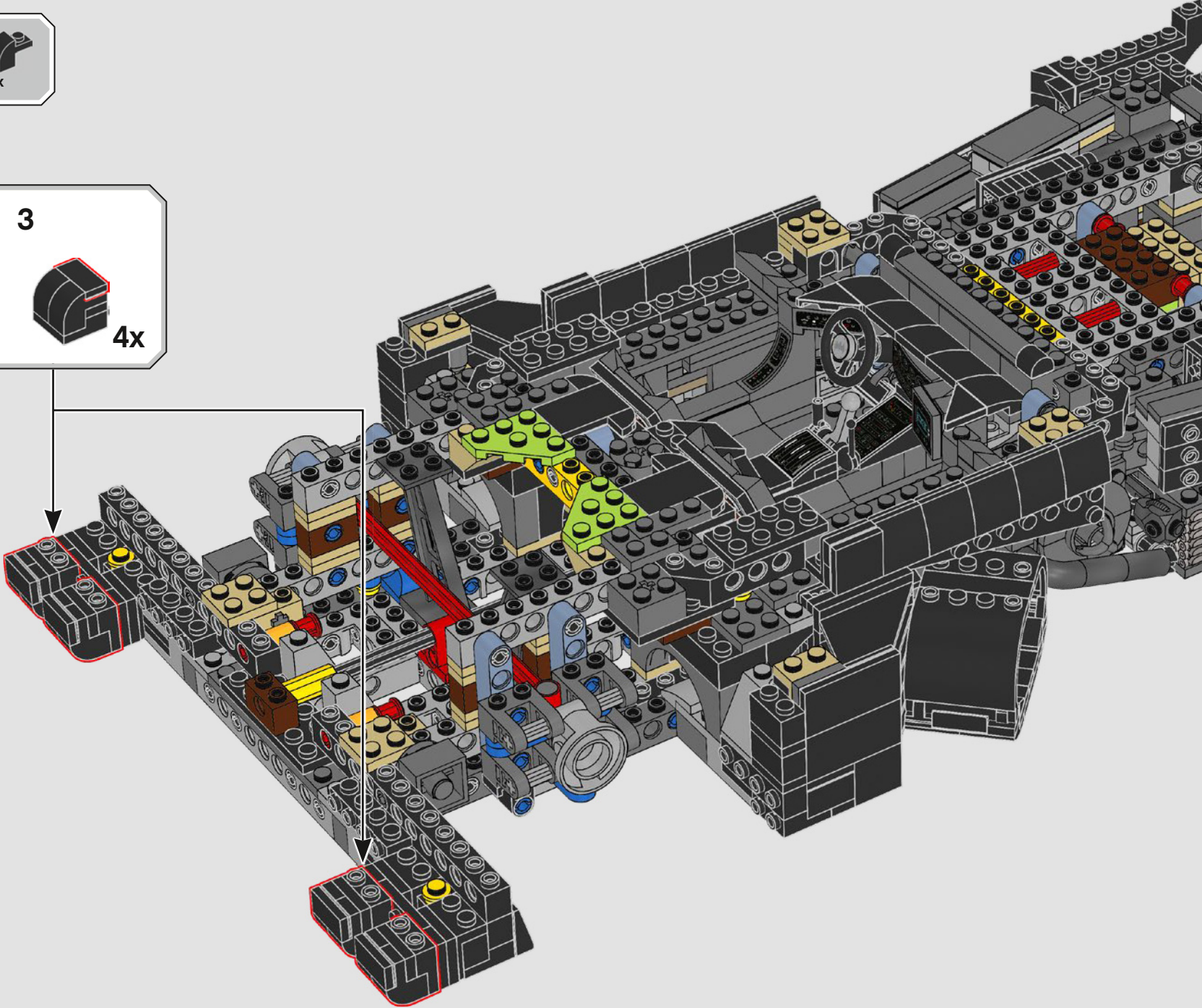
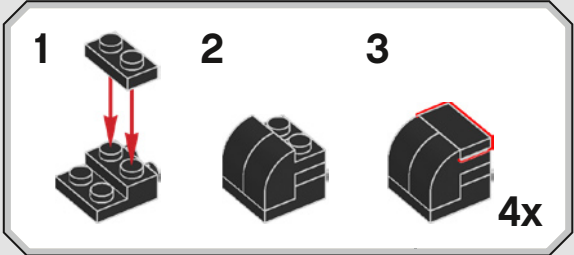



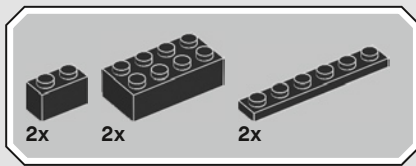

358

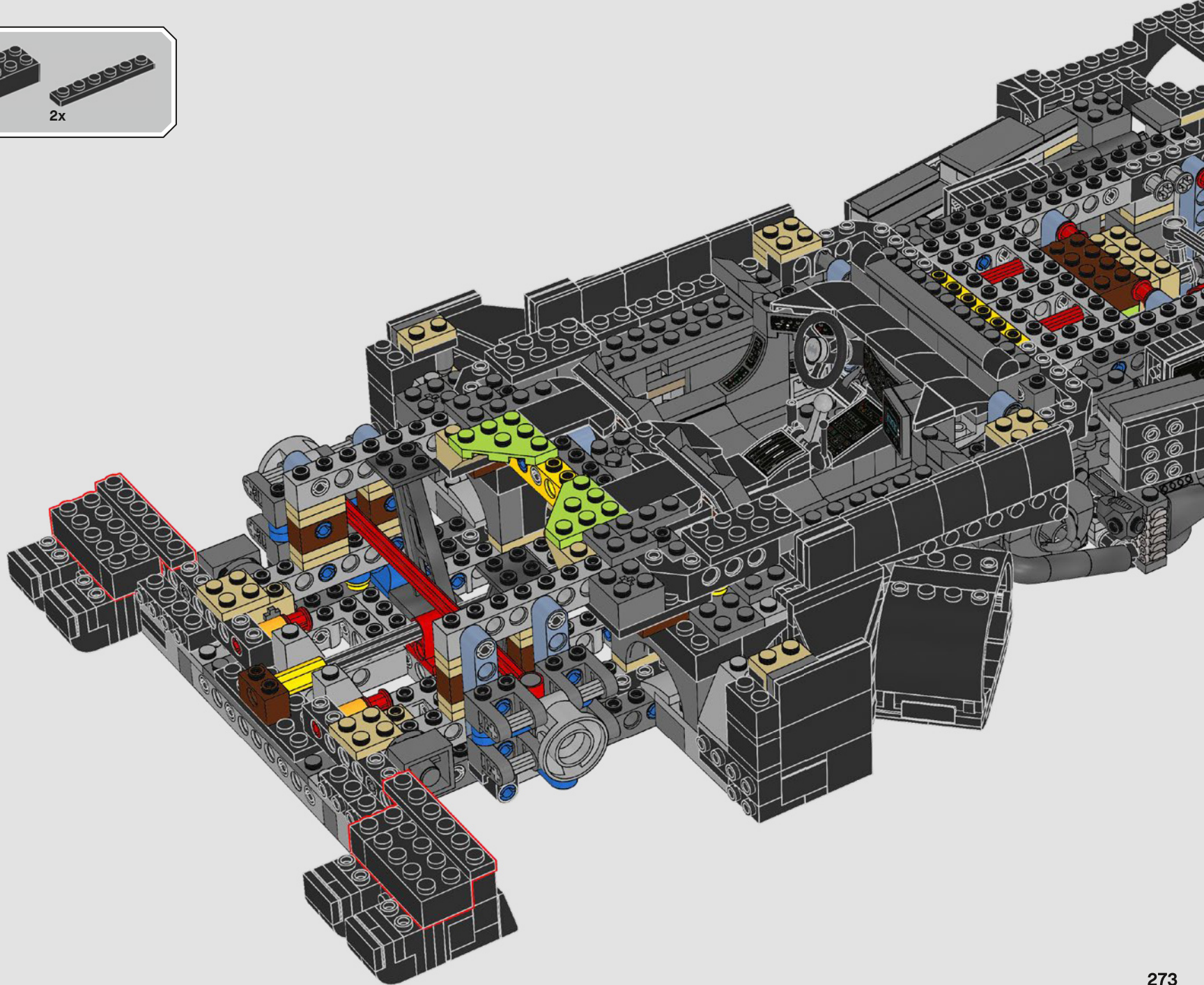



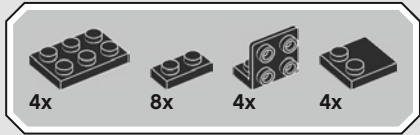
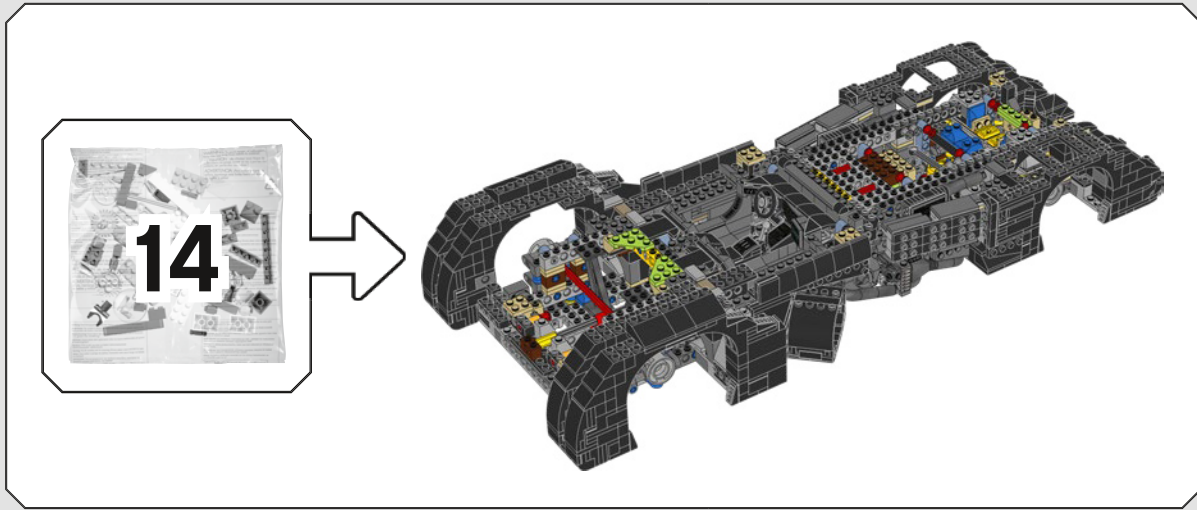

**360**

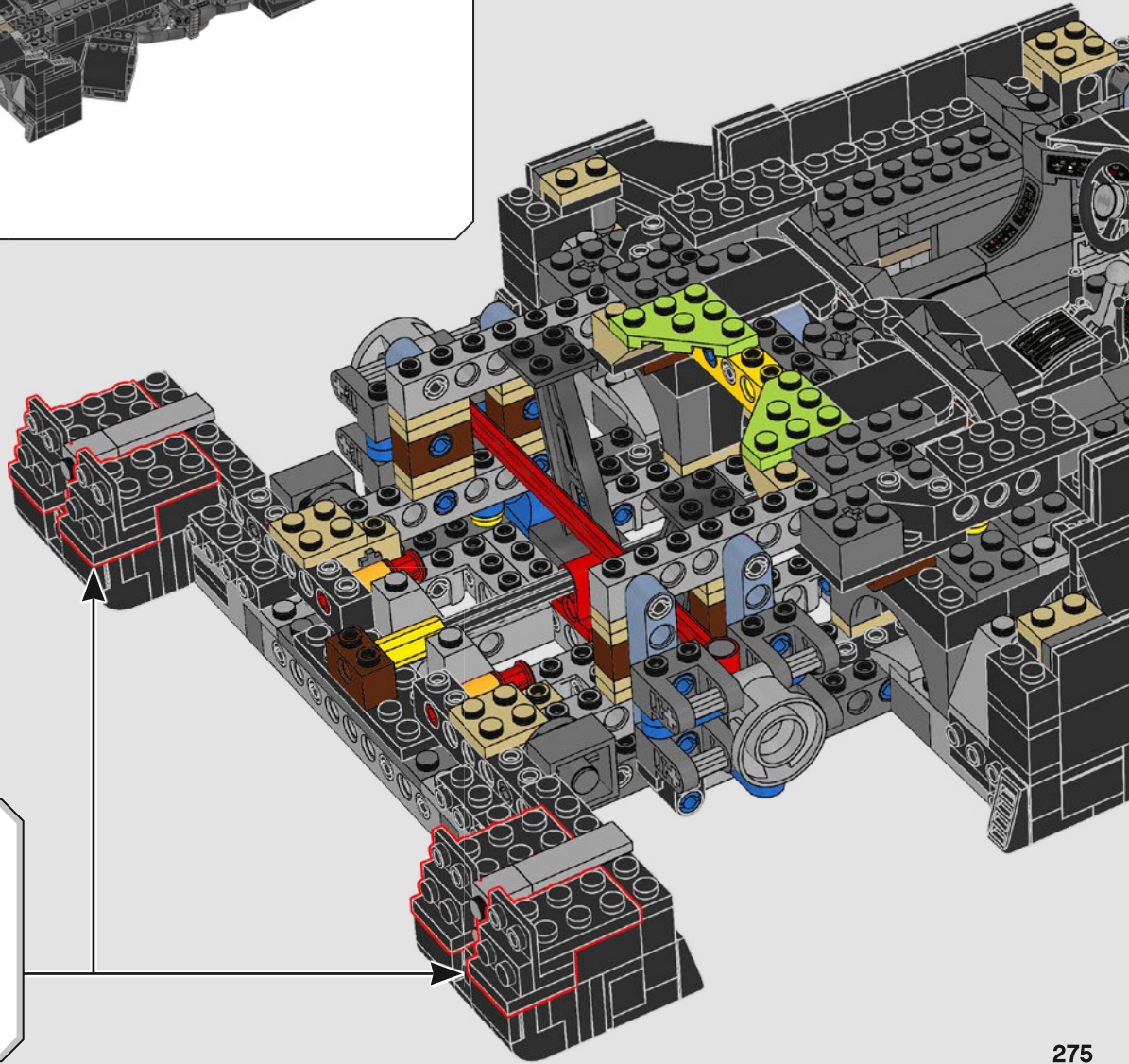
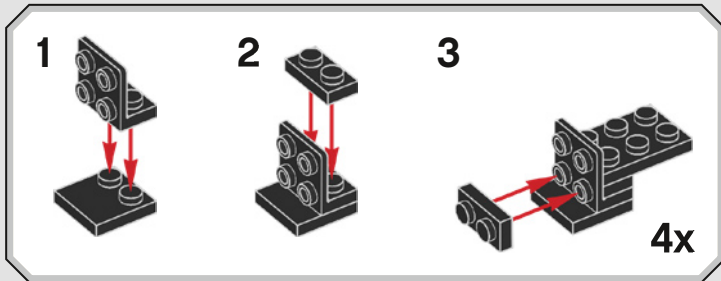

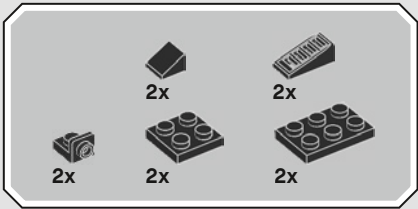

361

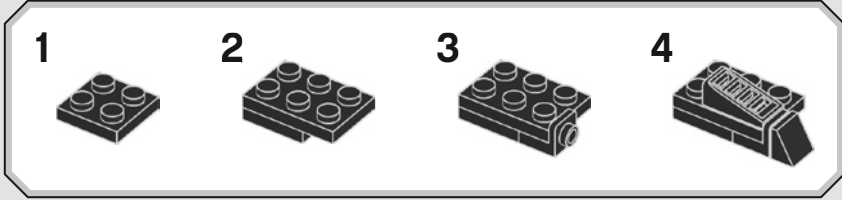
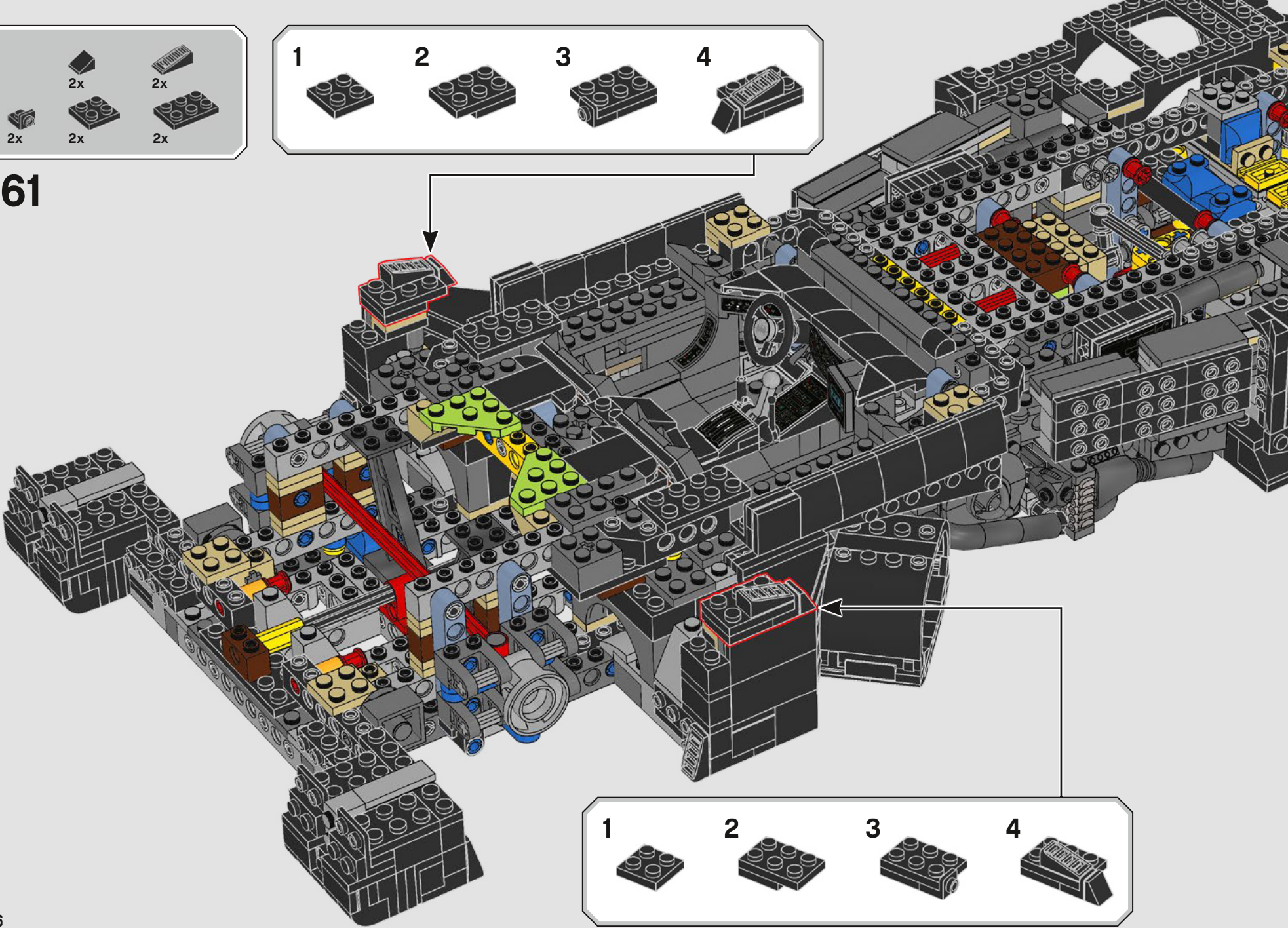
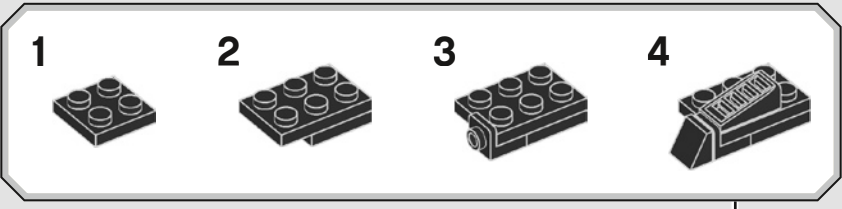

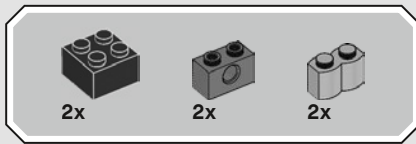

362

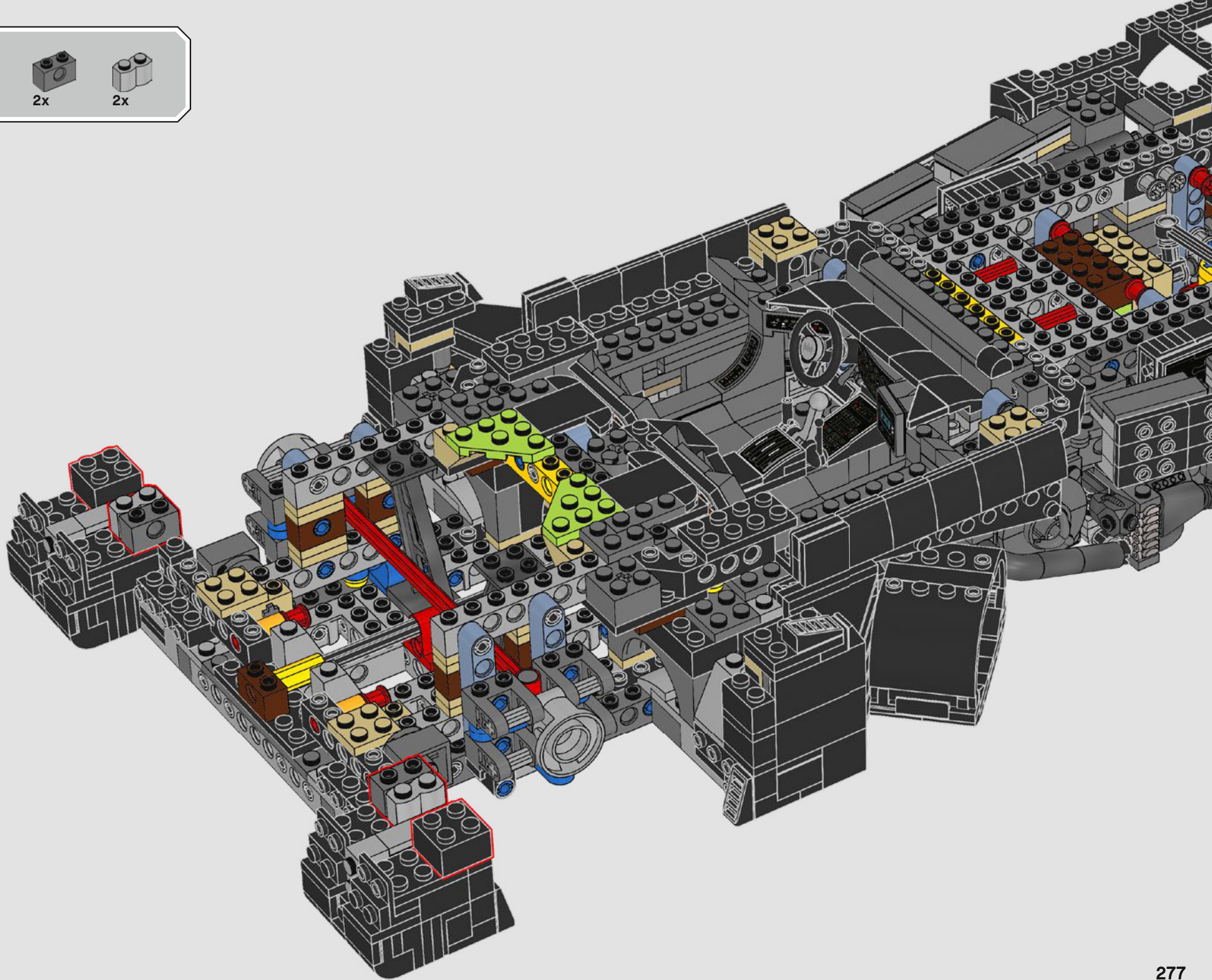

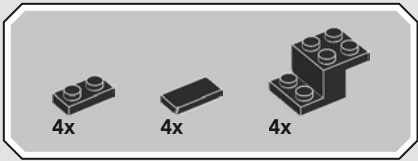

# 363

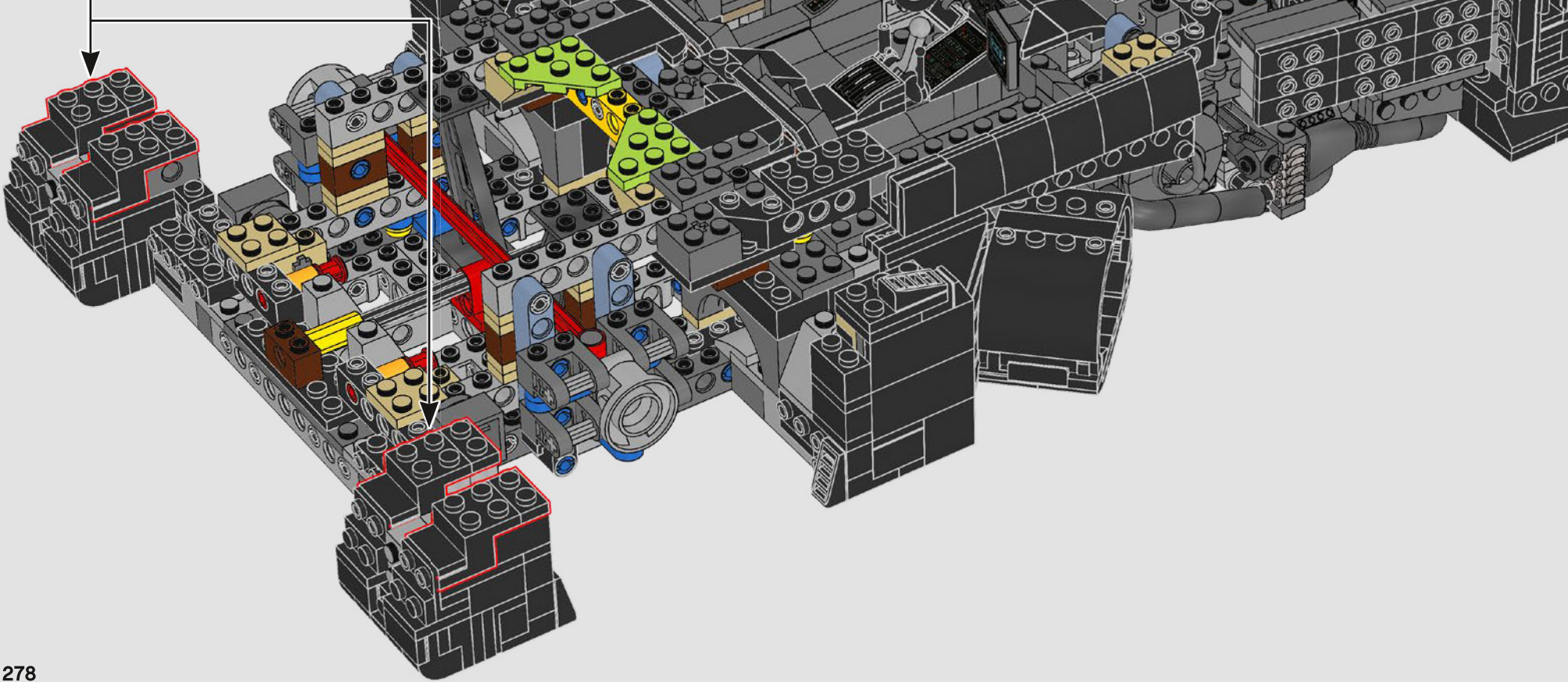
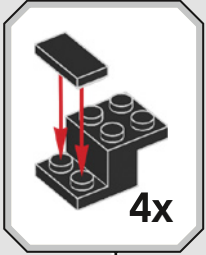

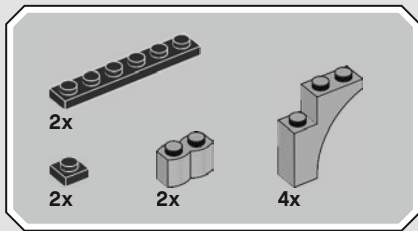

364

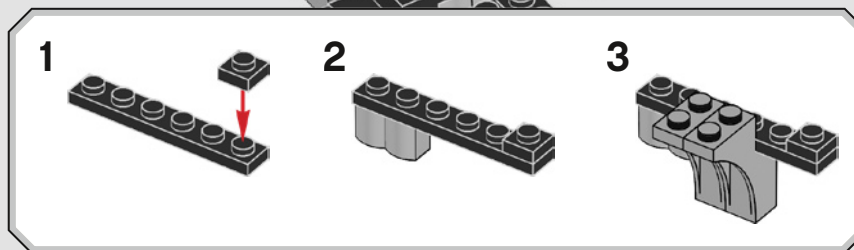
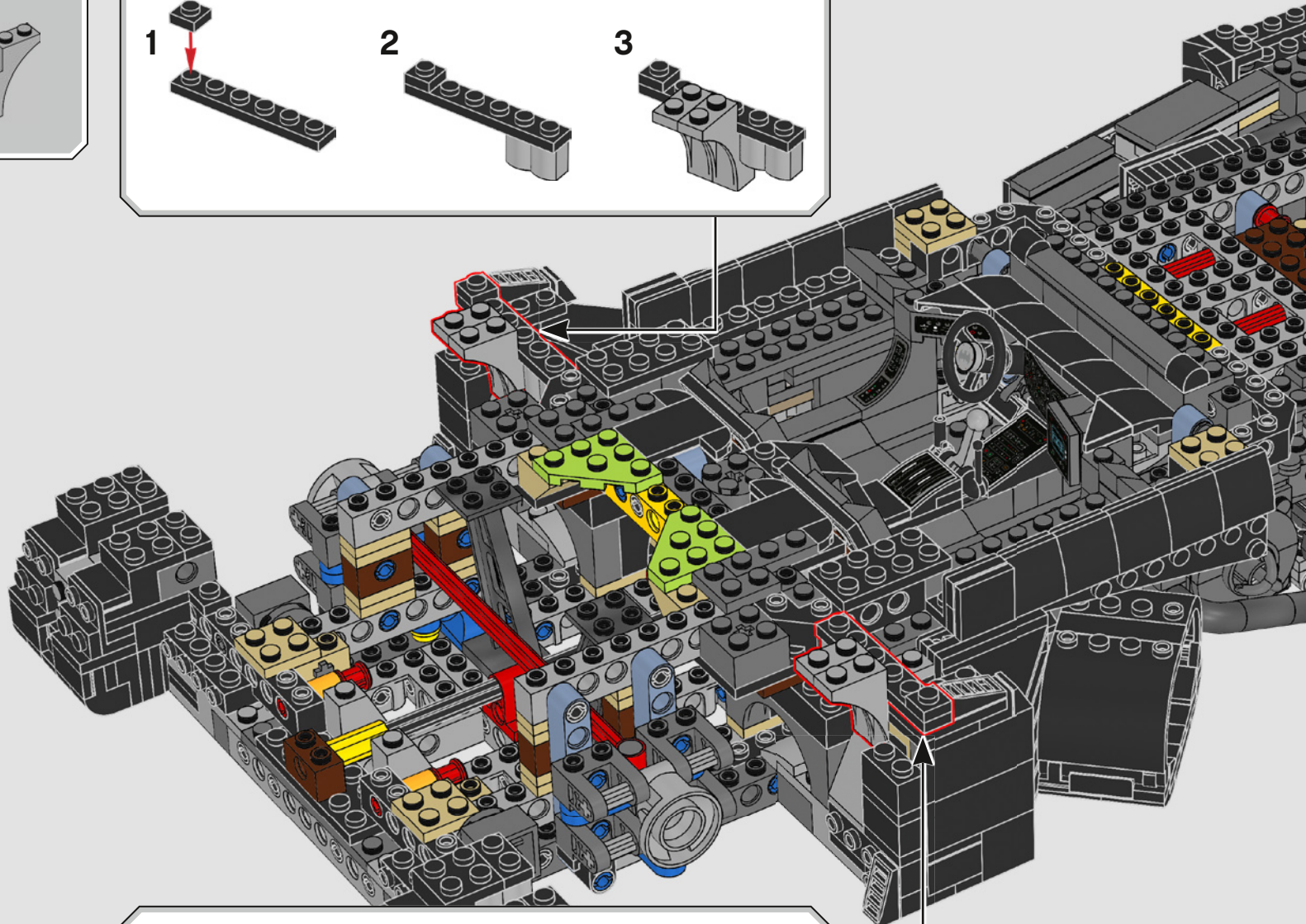
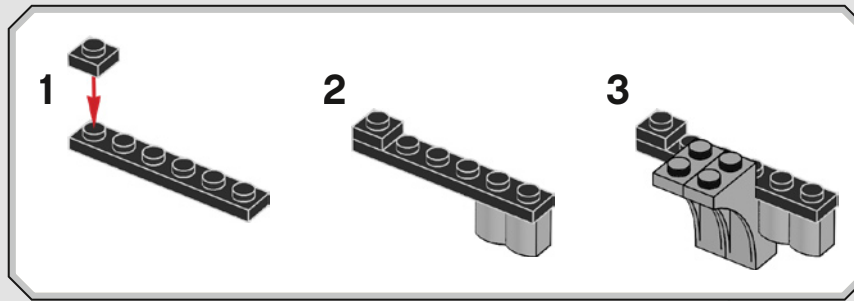

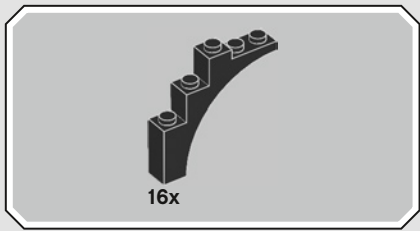

365

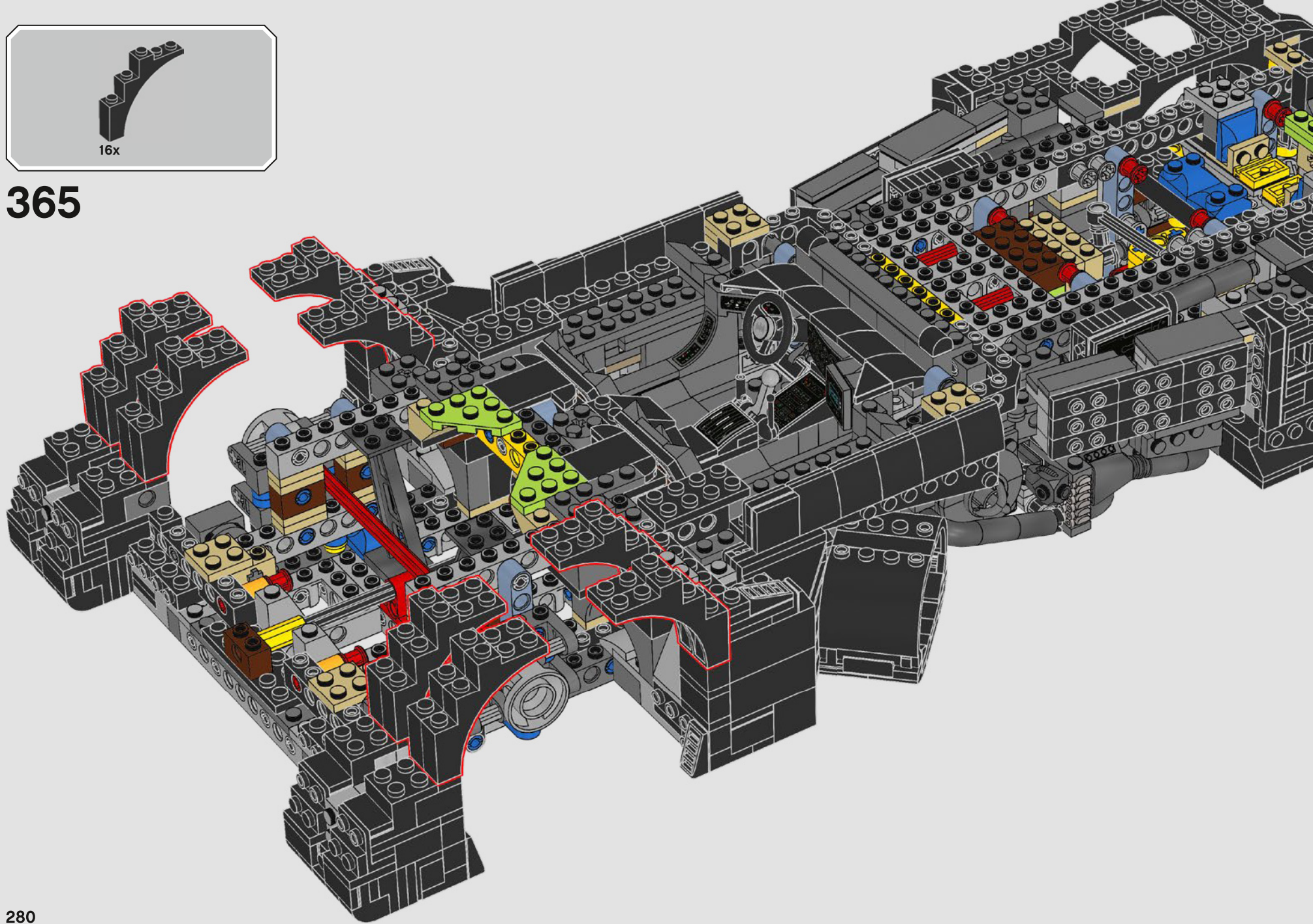



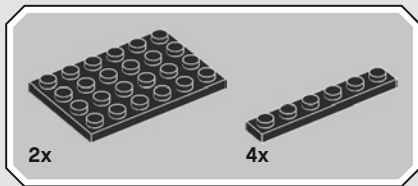

366

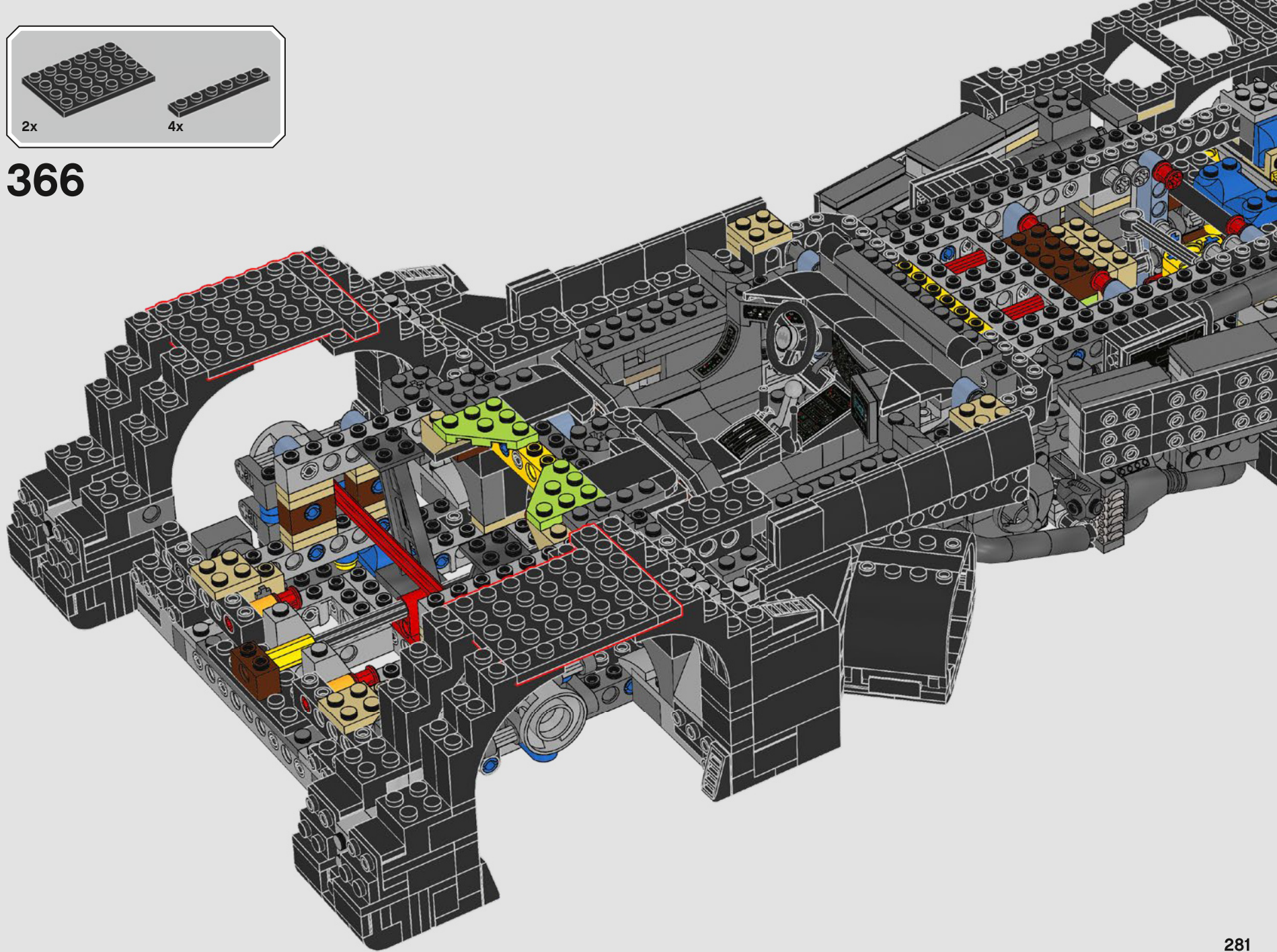

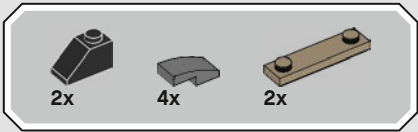

367

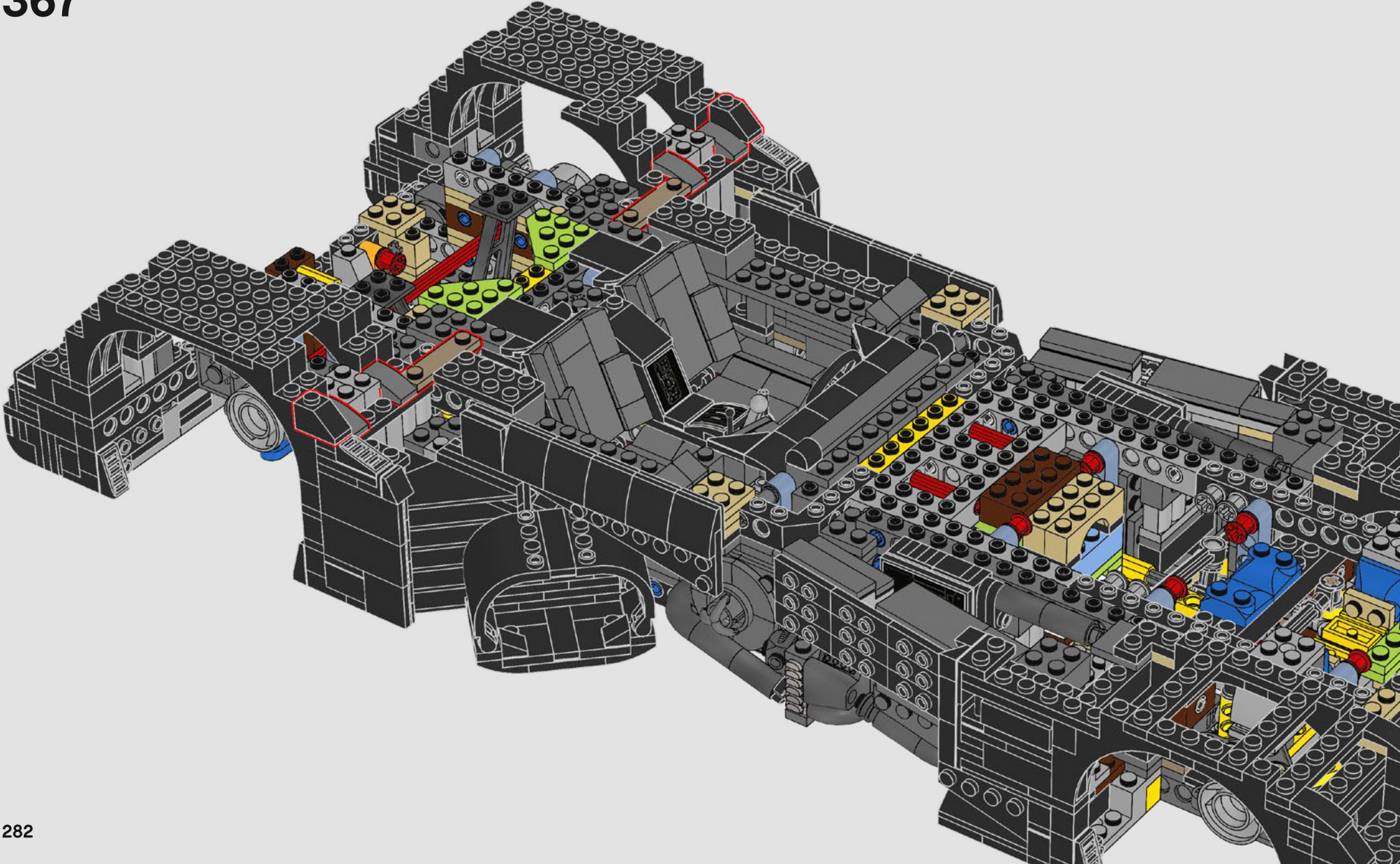

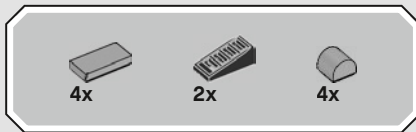

368

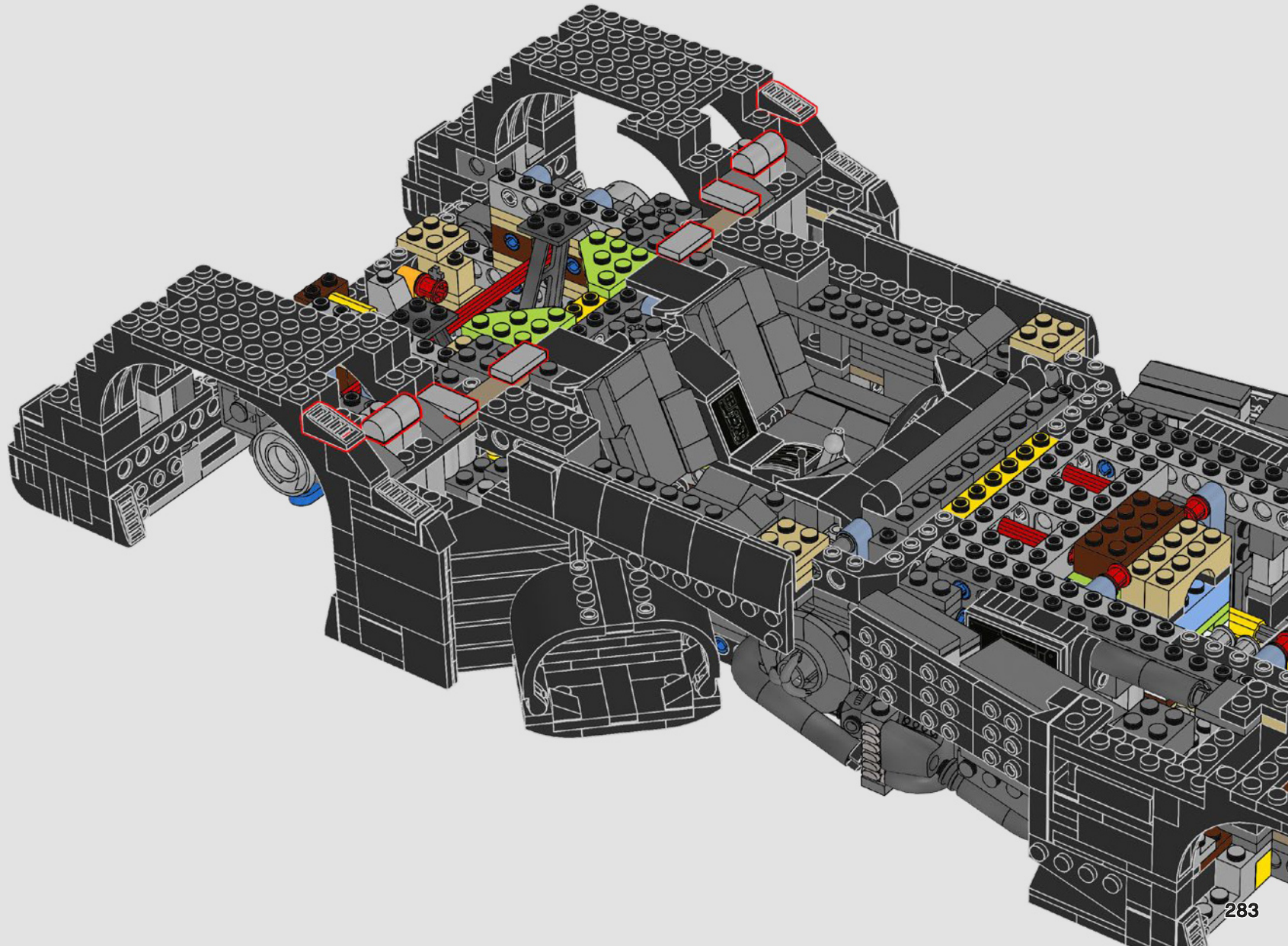

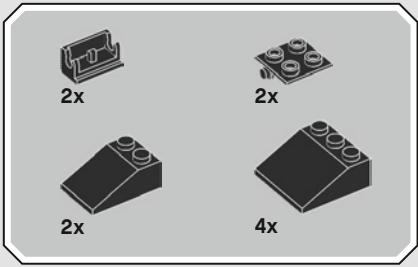

369

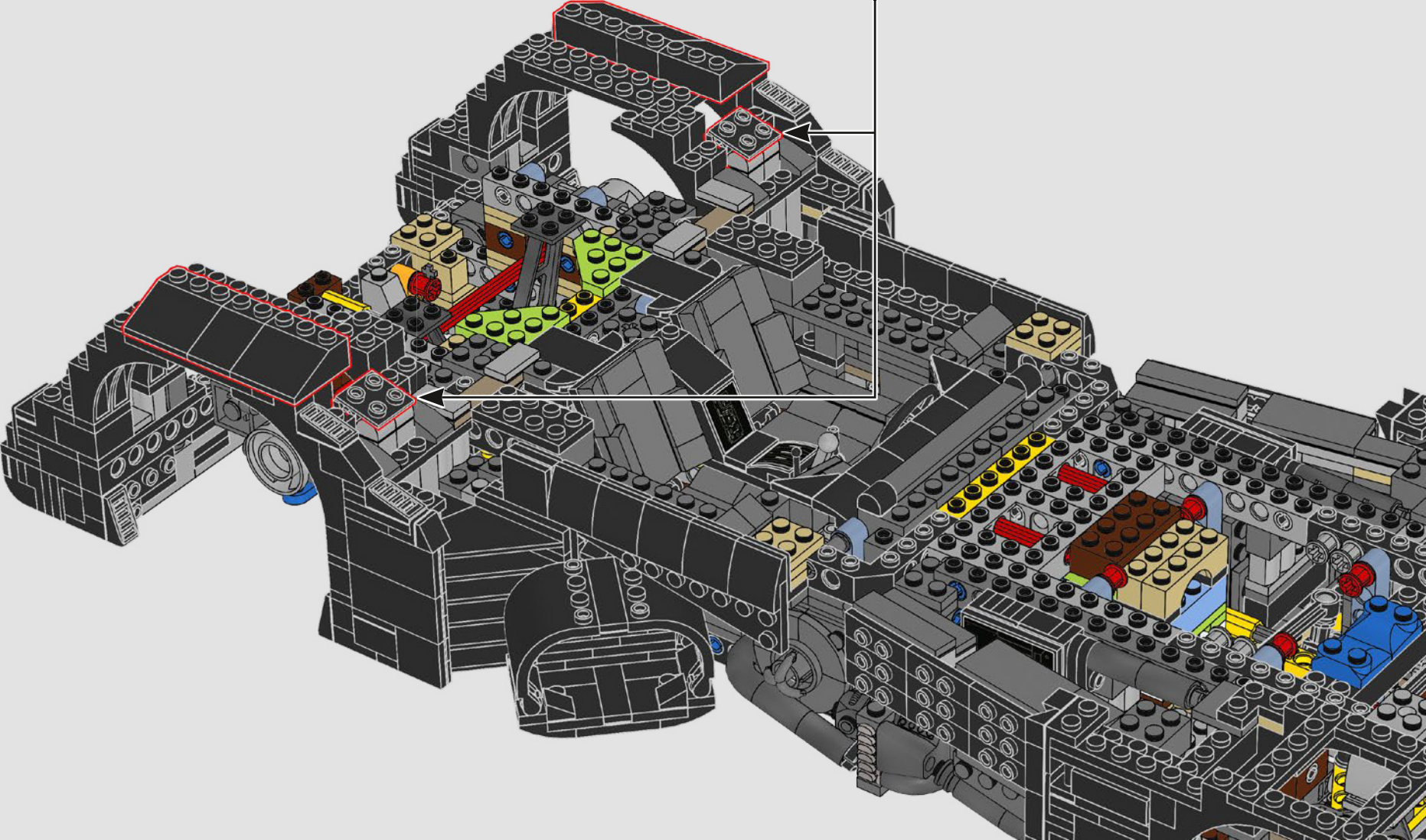
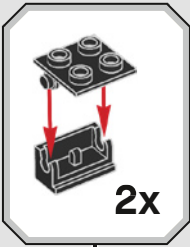

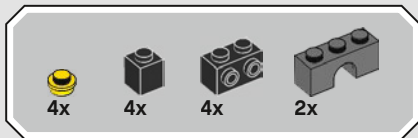

370

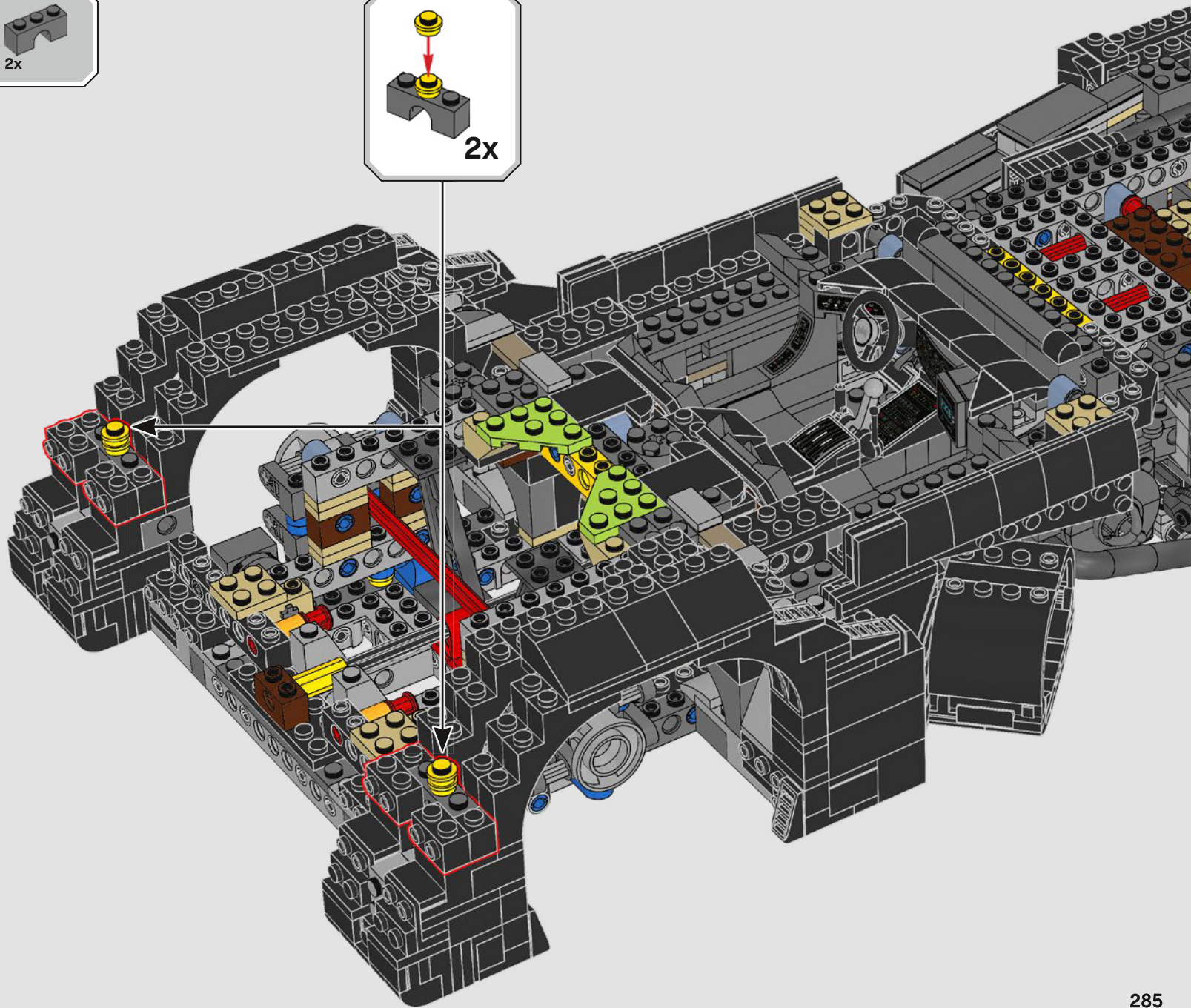
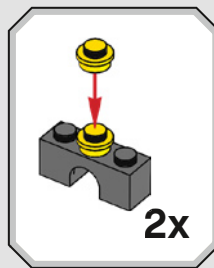

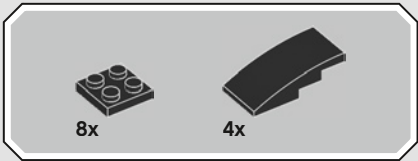

371

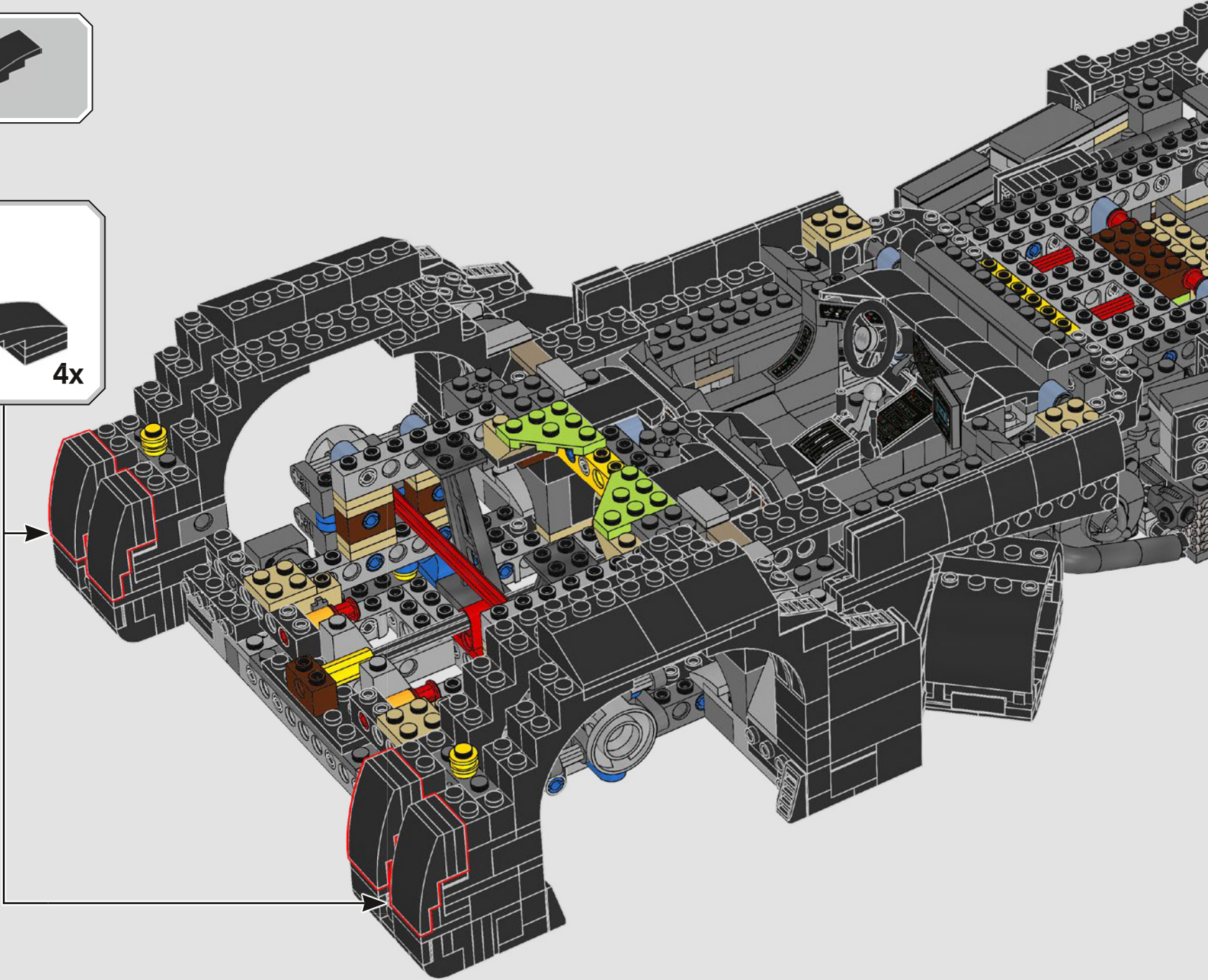
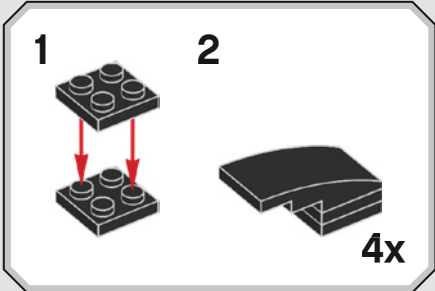



12x

372

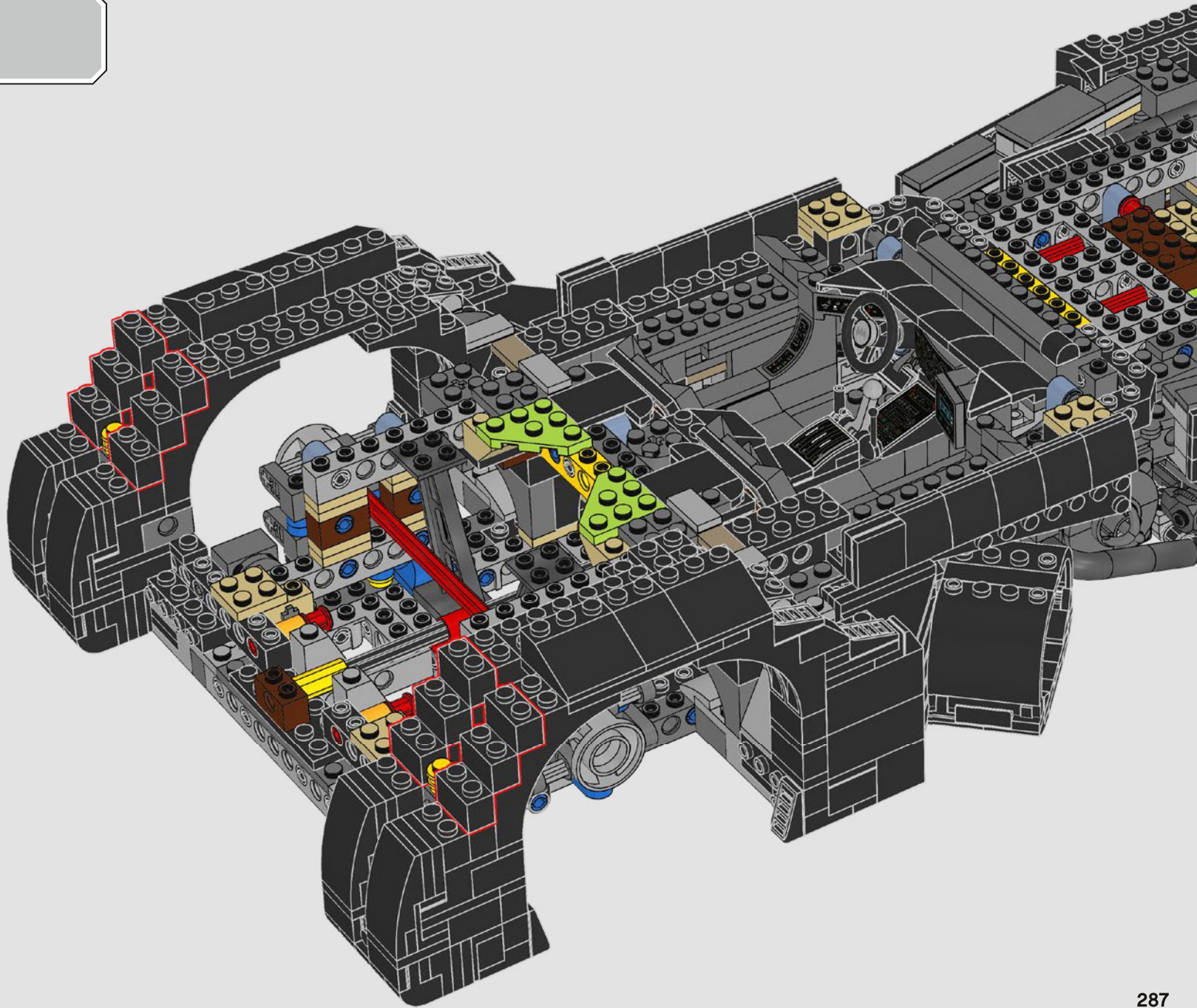

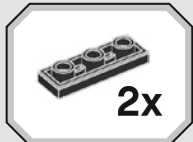
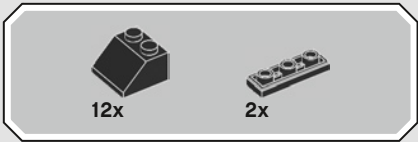

373

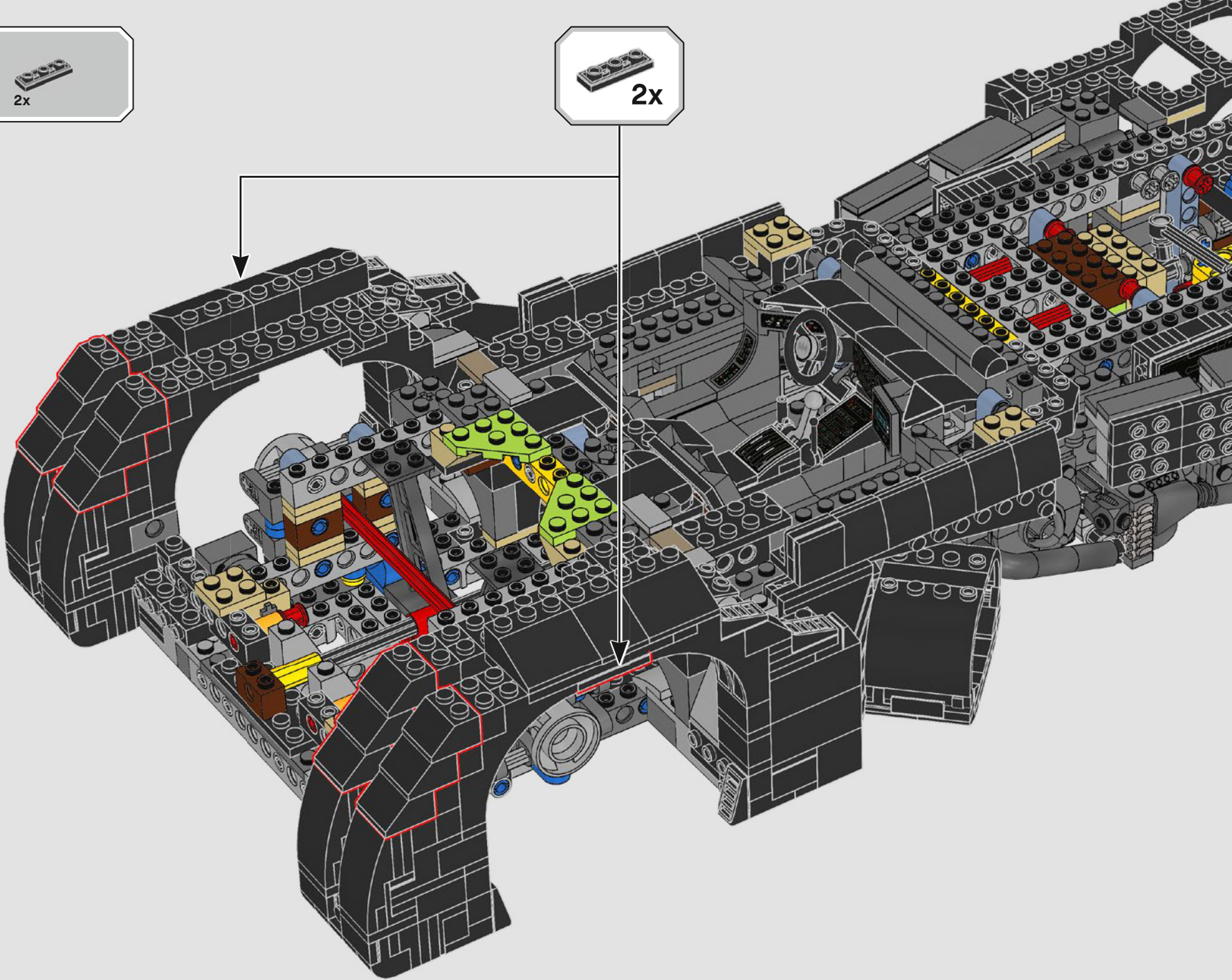



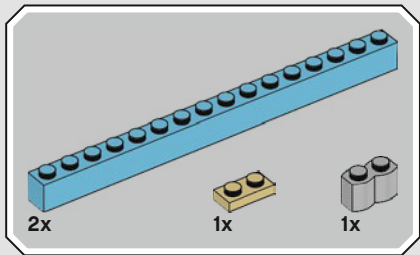
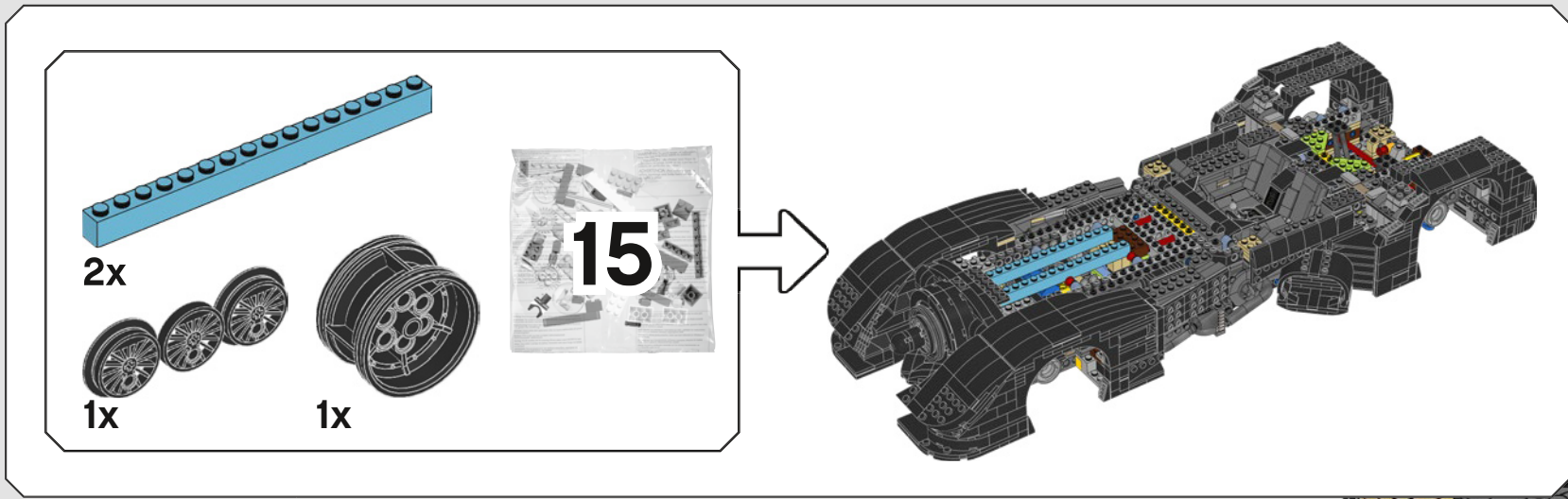

374

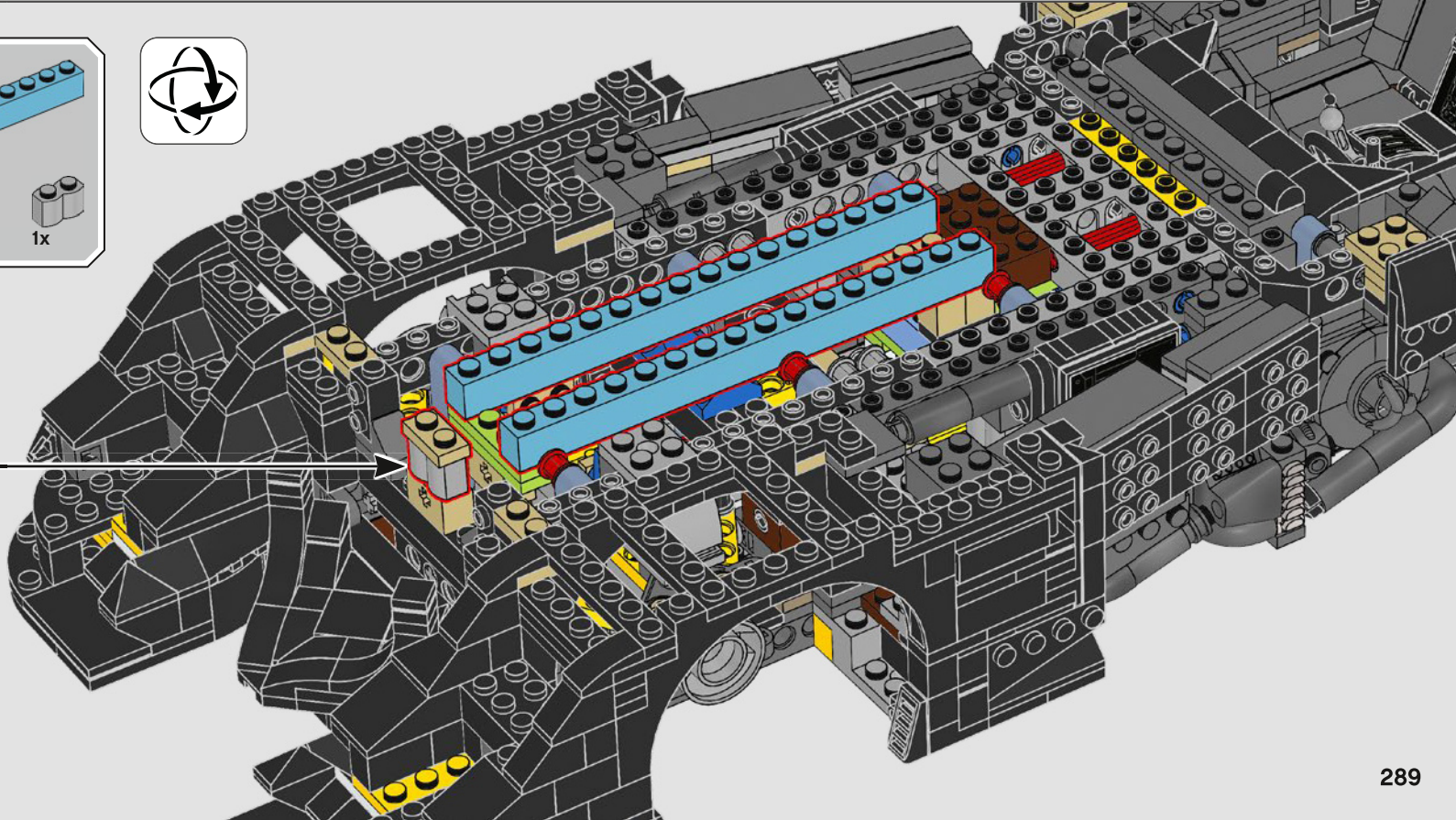
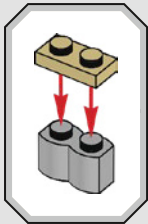

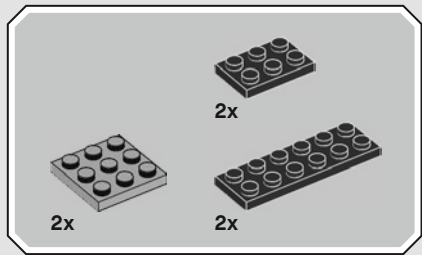

375

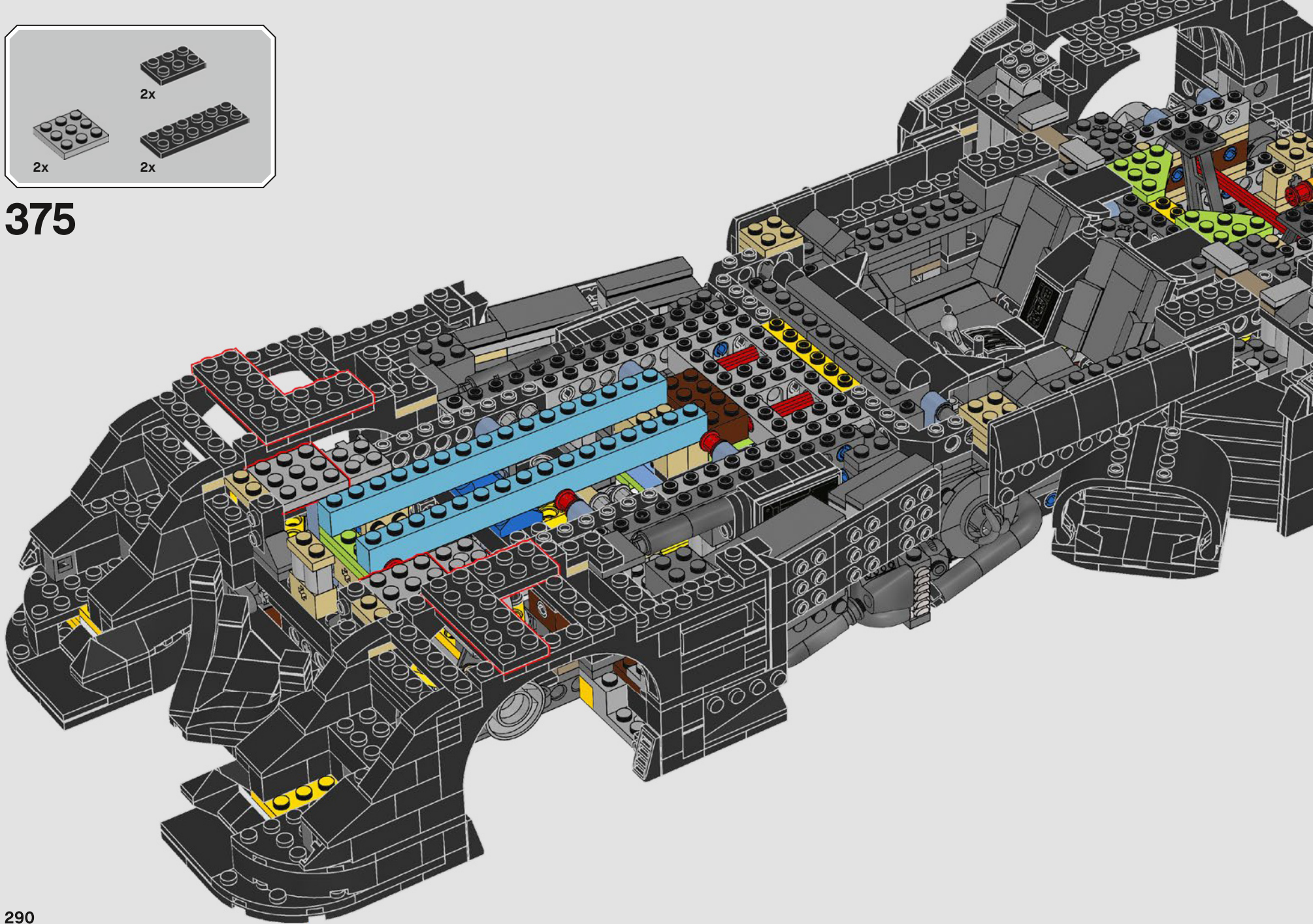

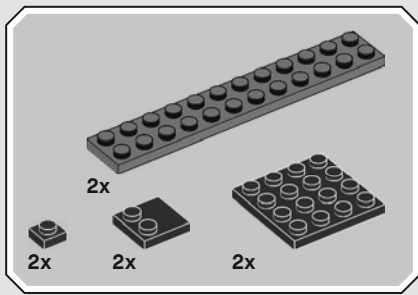

376

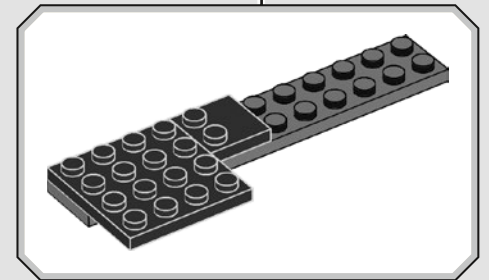
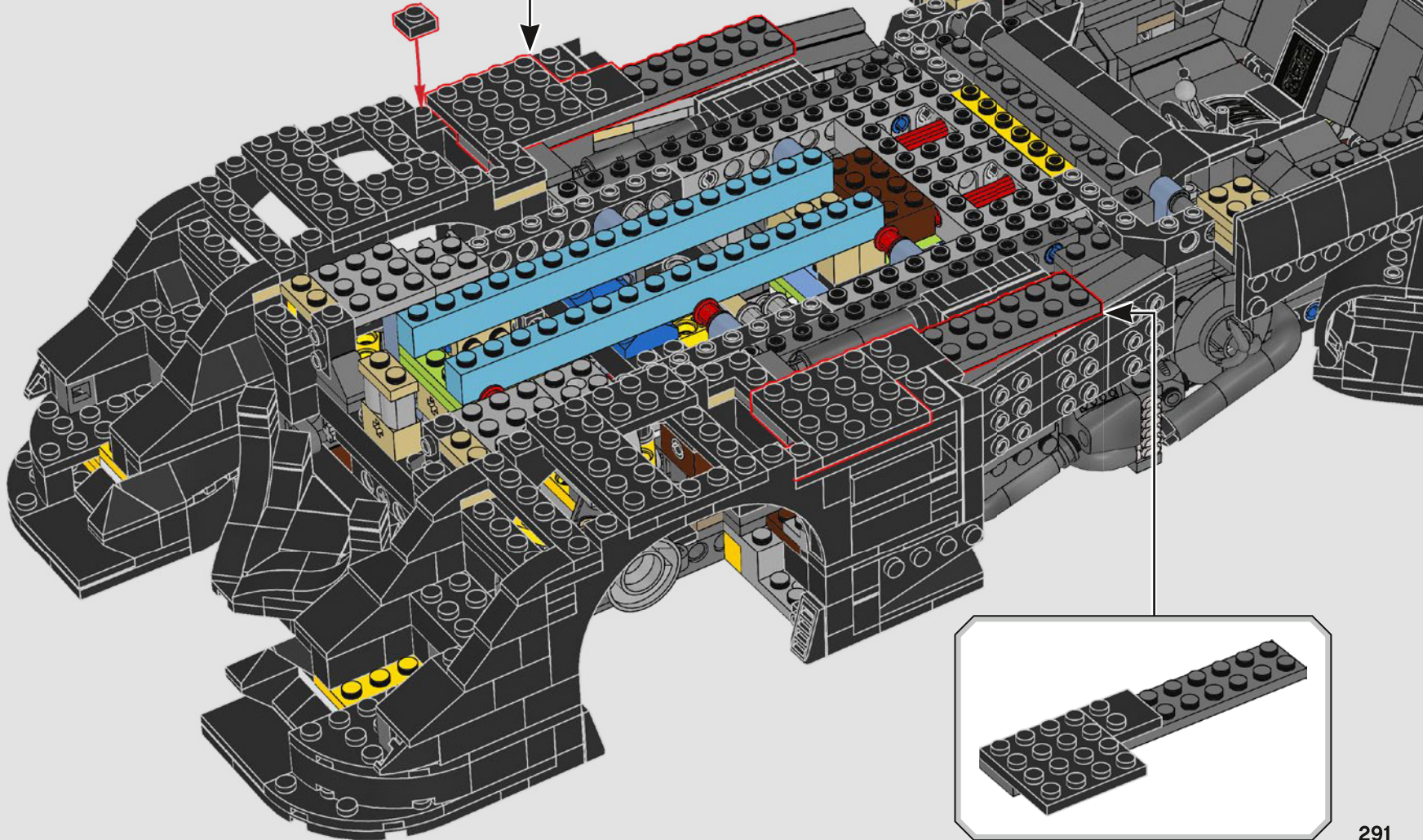
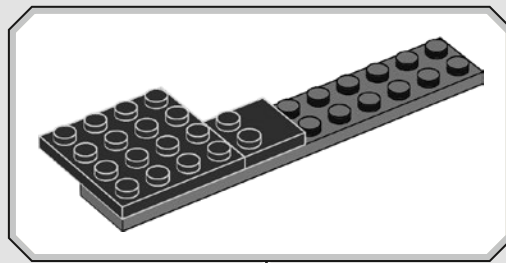

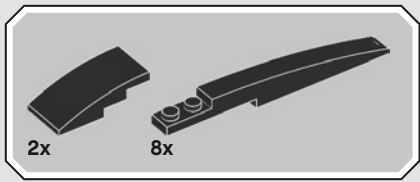

377

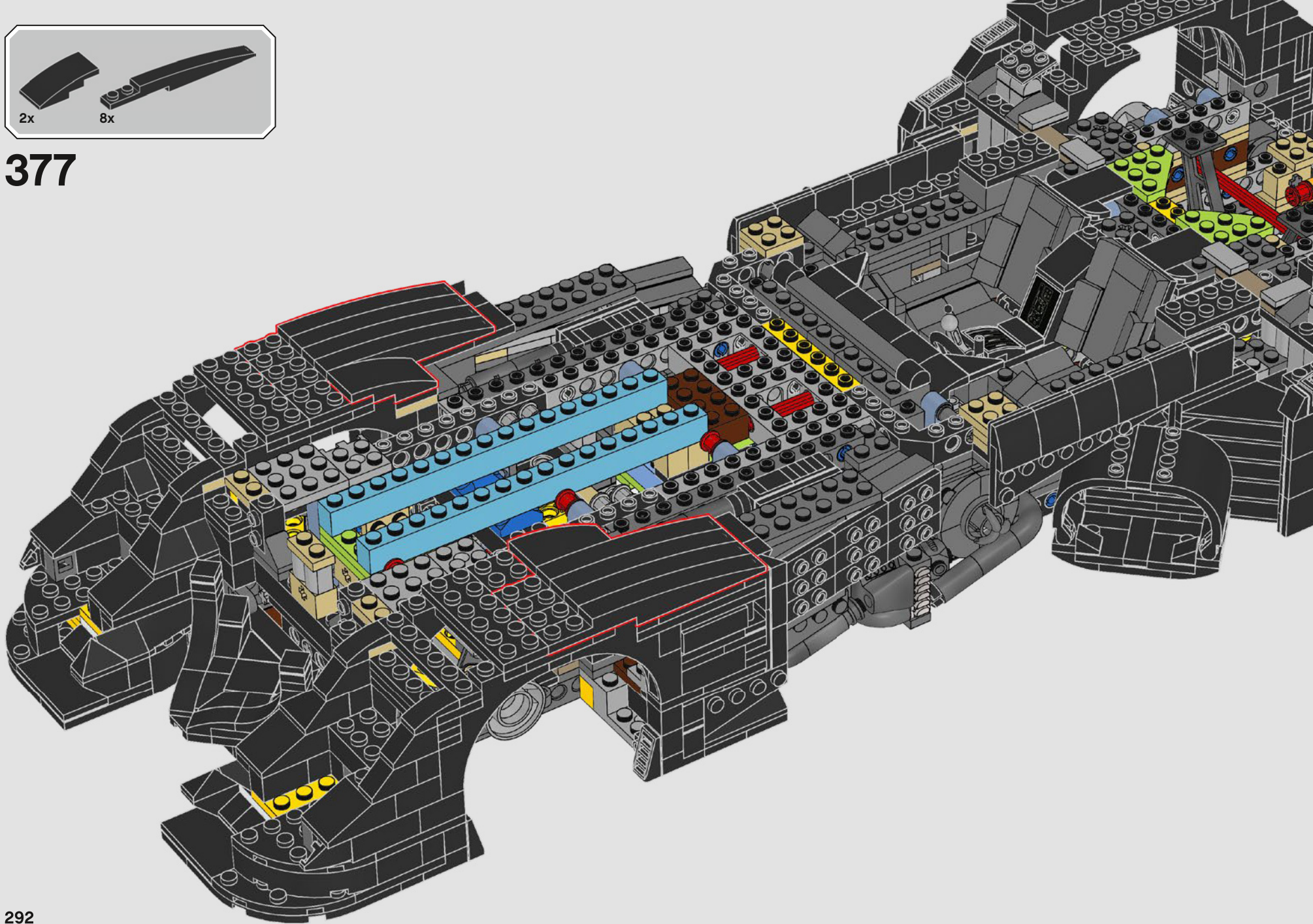

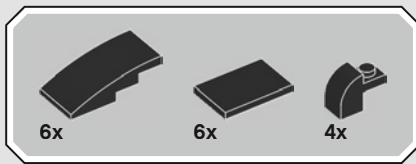

378

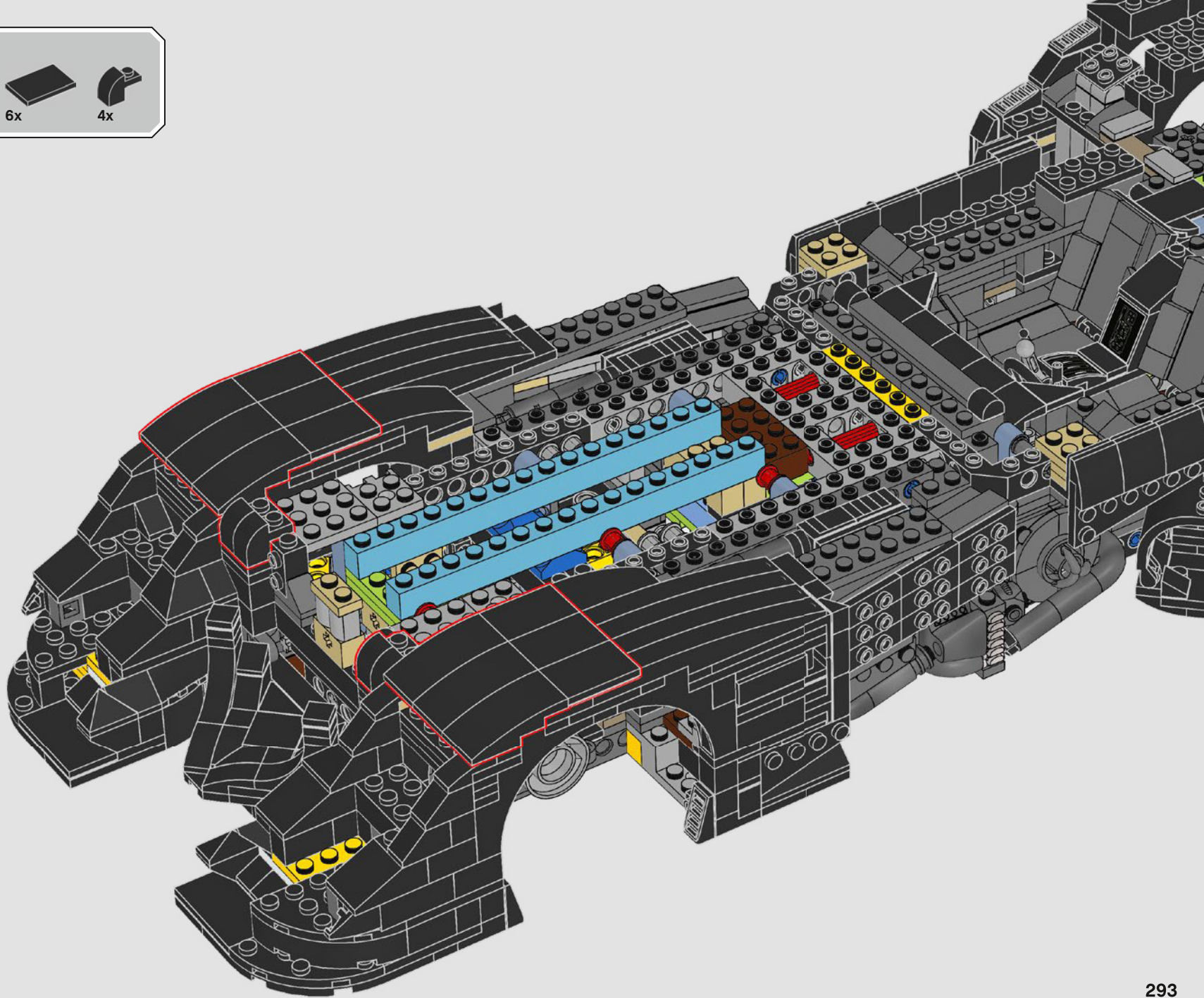

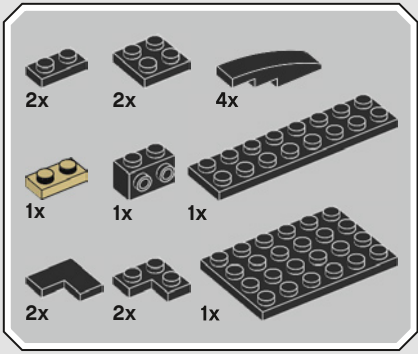

# 379

1

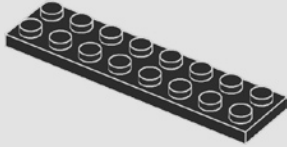

2

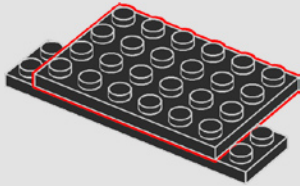

3

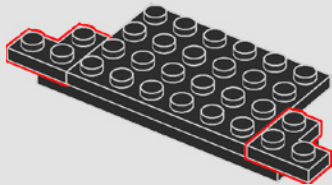

4

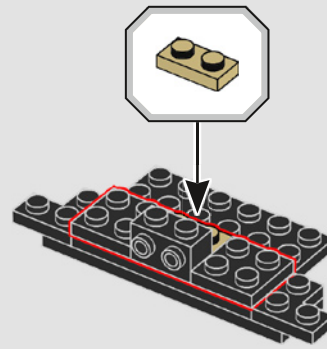

5

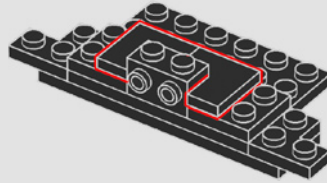

6

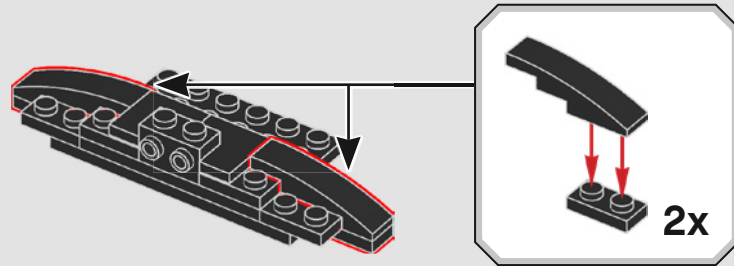

7

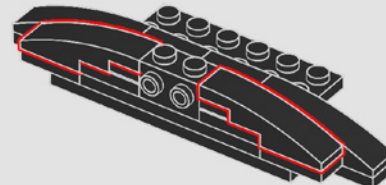

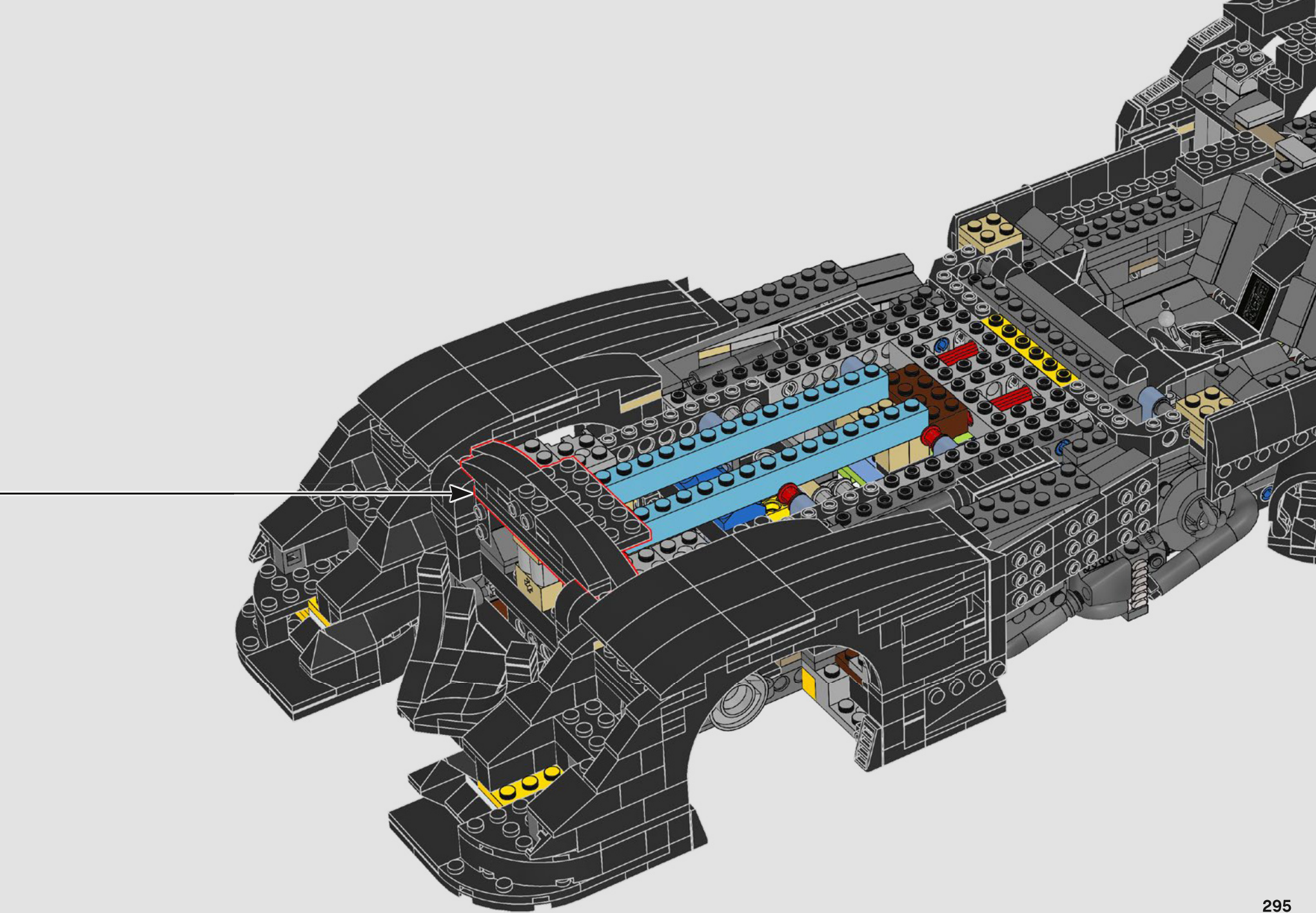

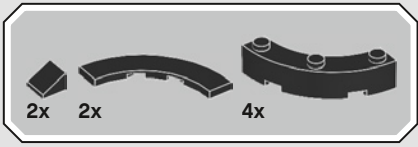

380

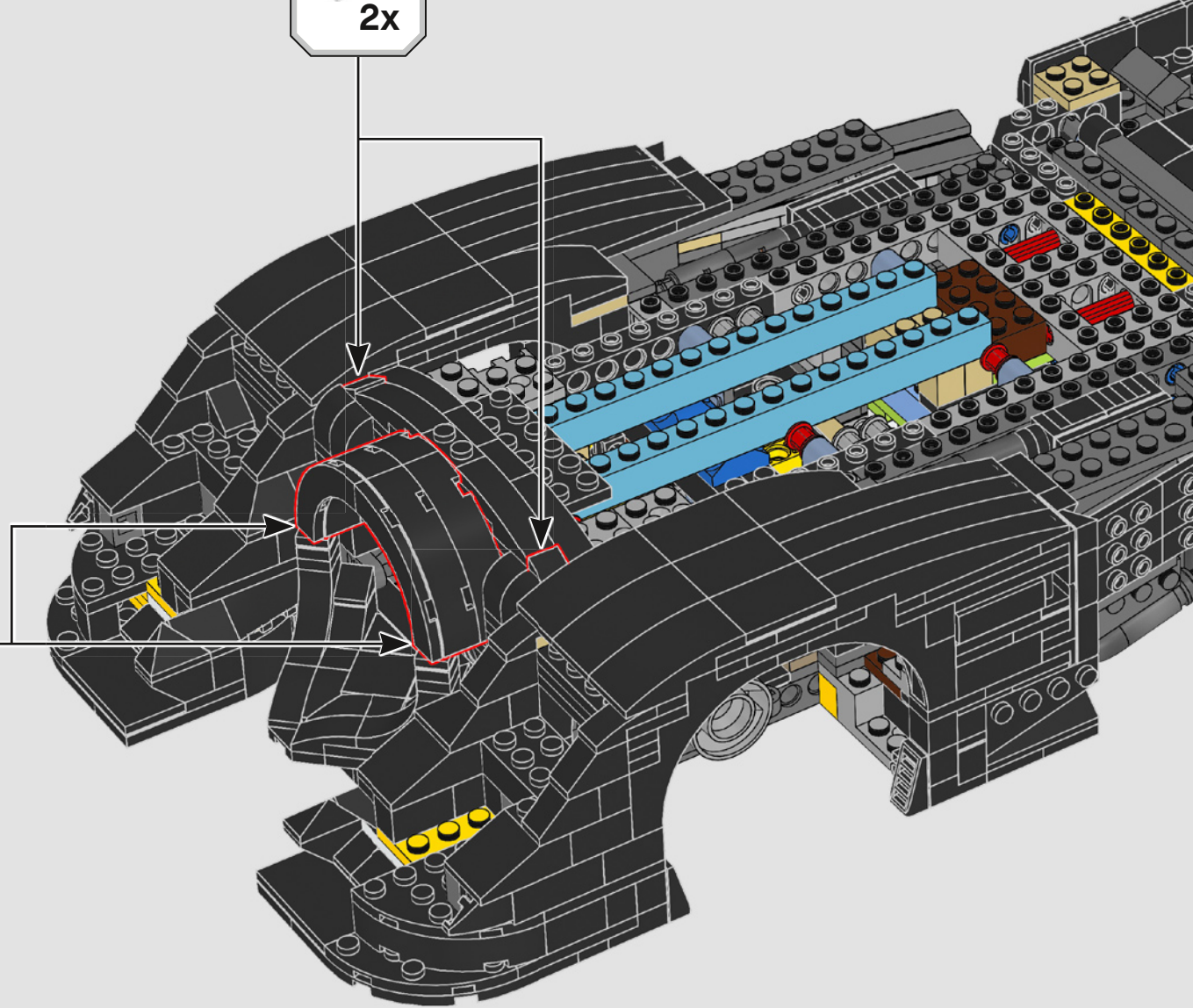
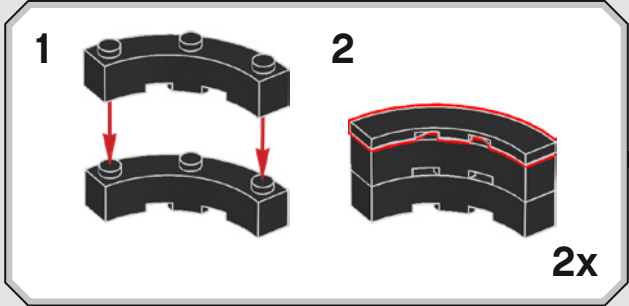



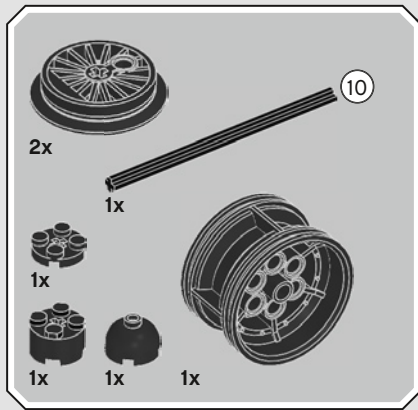

381

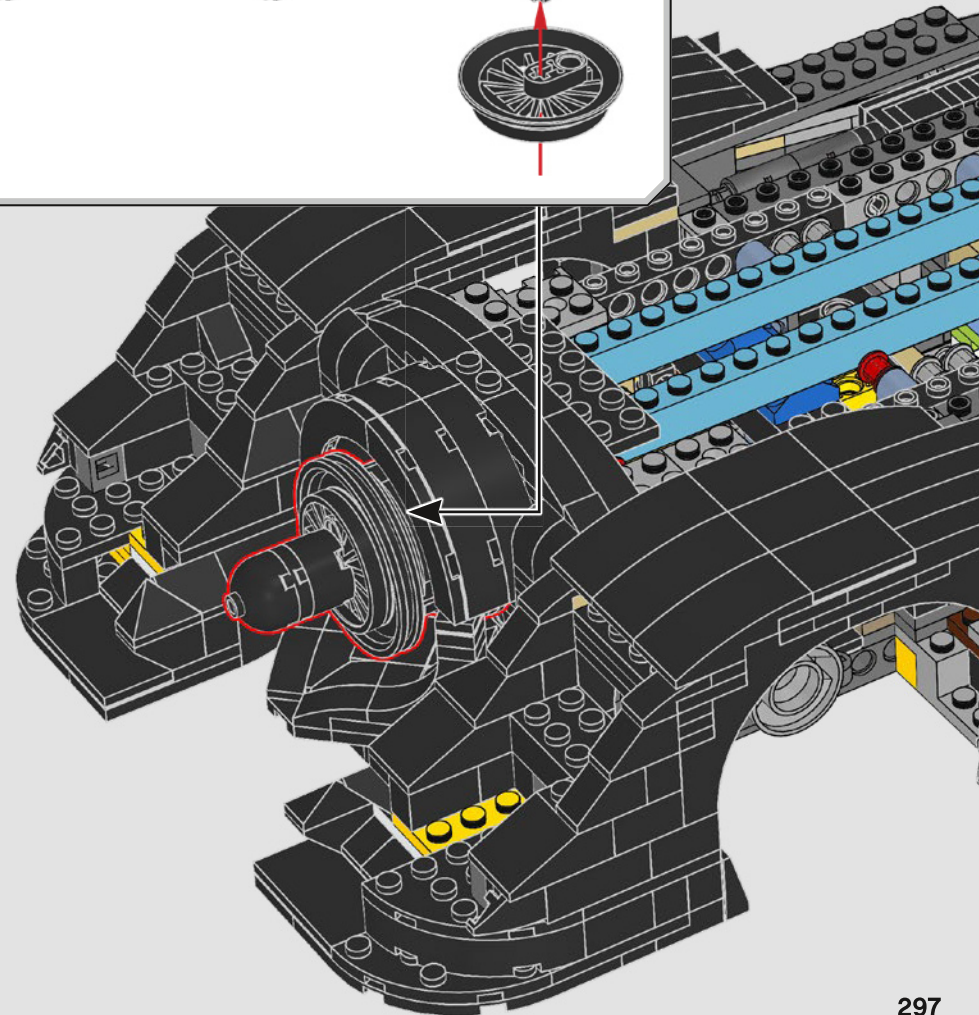
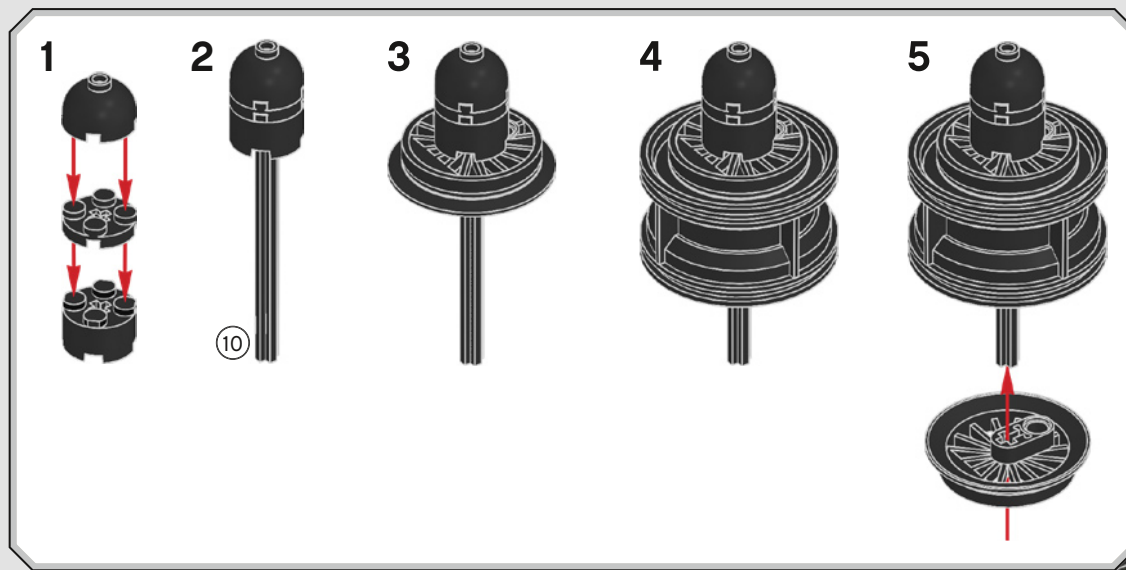

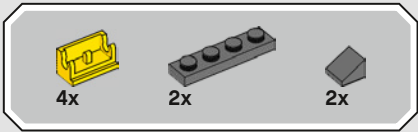

# 382

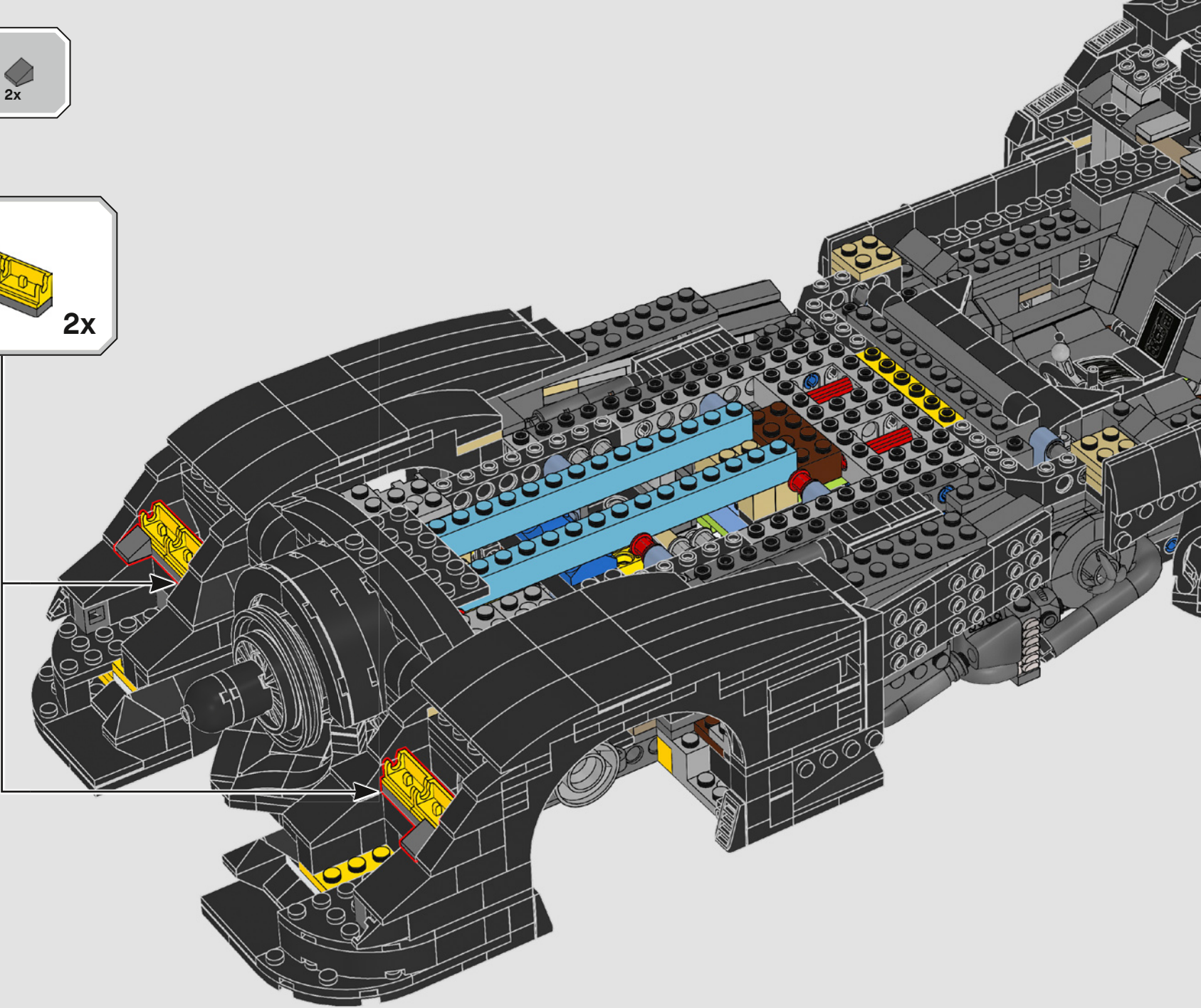
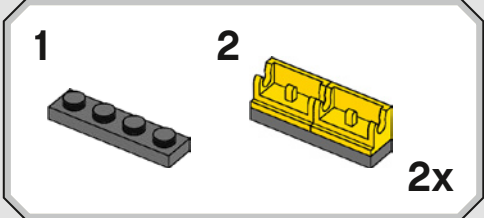

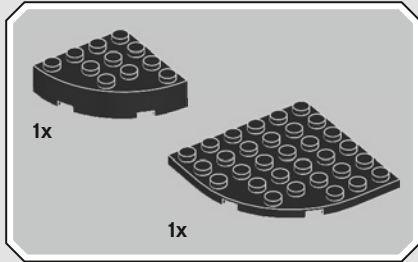
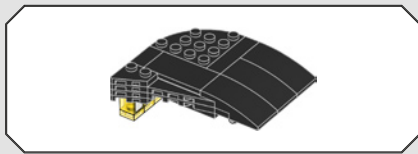

**383**

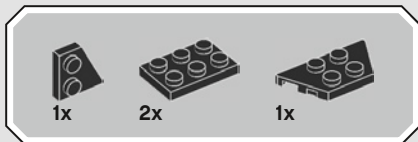
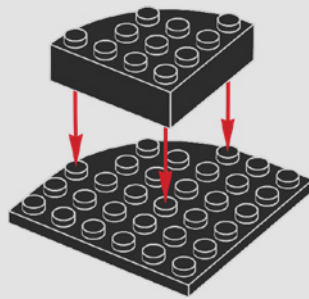

**384**

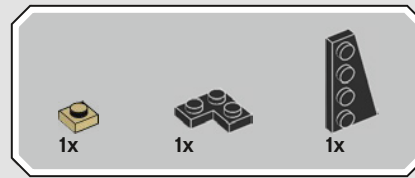
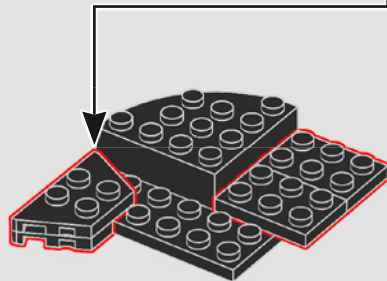
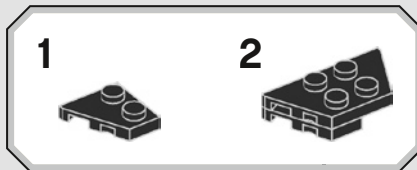

**385**

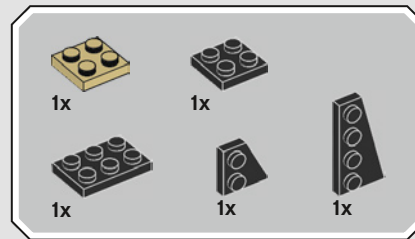
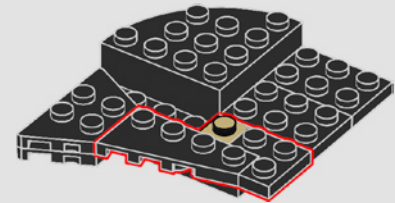

**386**

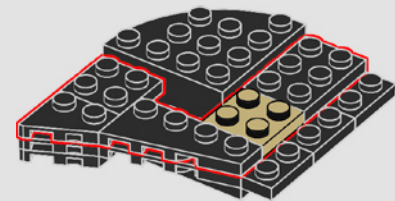

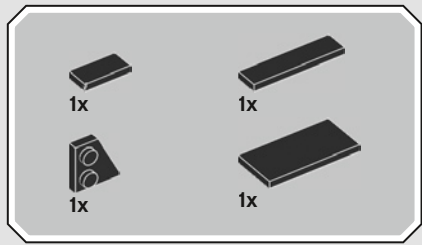

387

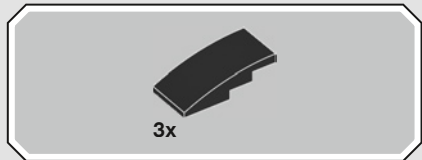
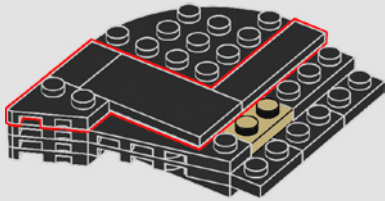

388

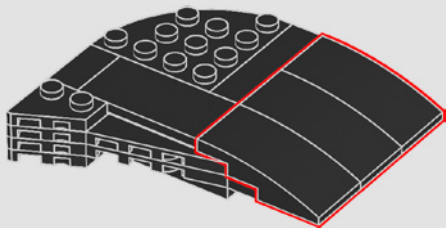

389

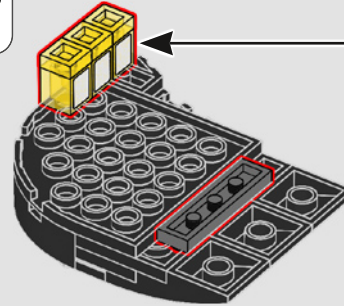
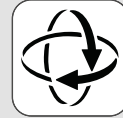
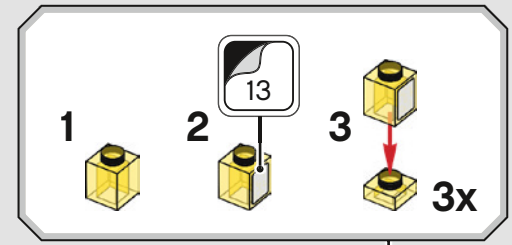

390

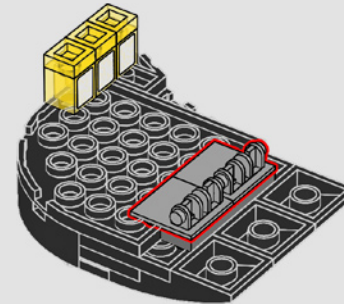

391

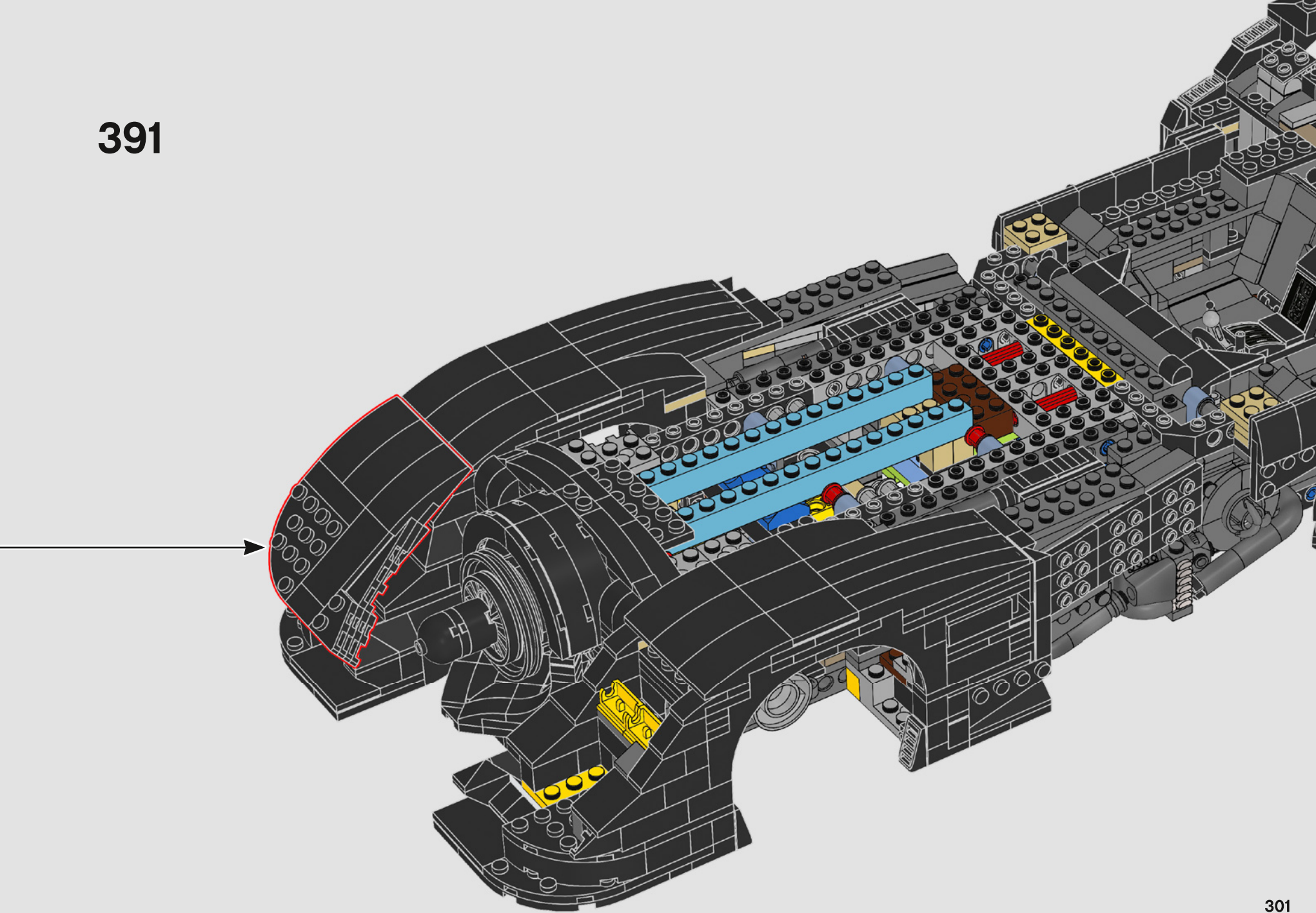

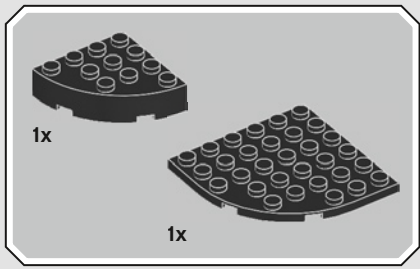

392

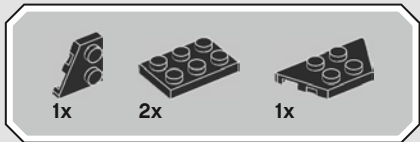
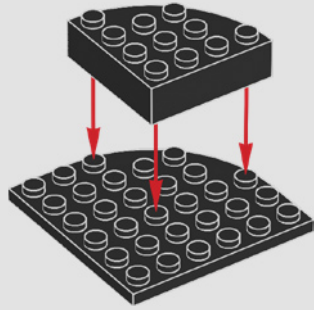

393

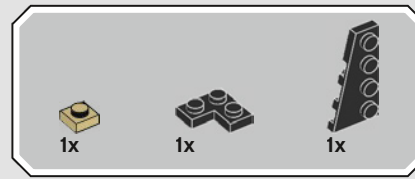
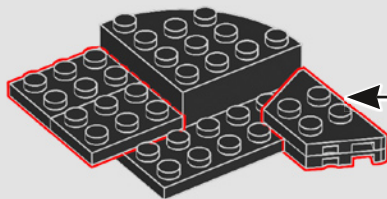
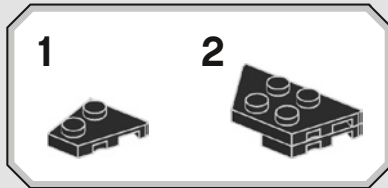

394

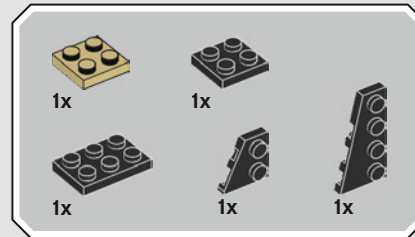
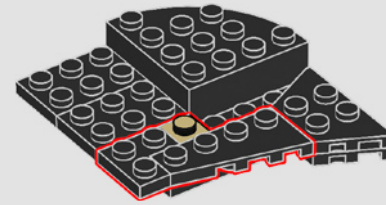

395

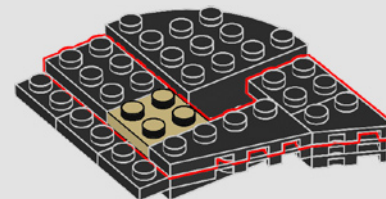

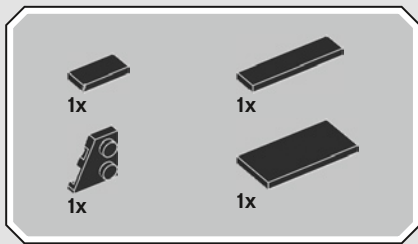

396

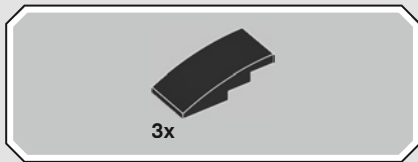
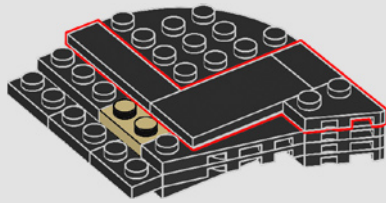

397

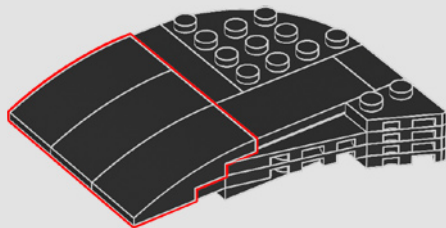

398

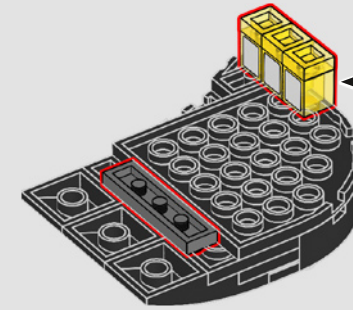
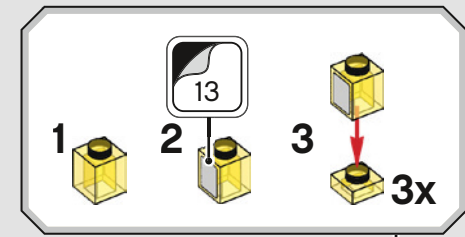

399

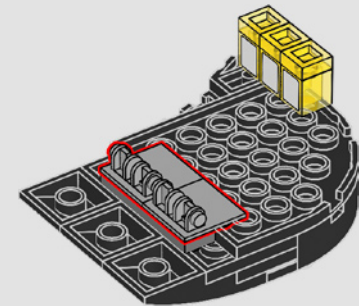

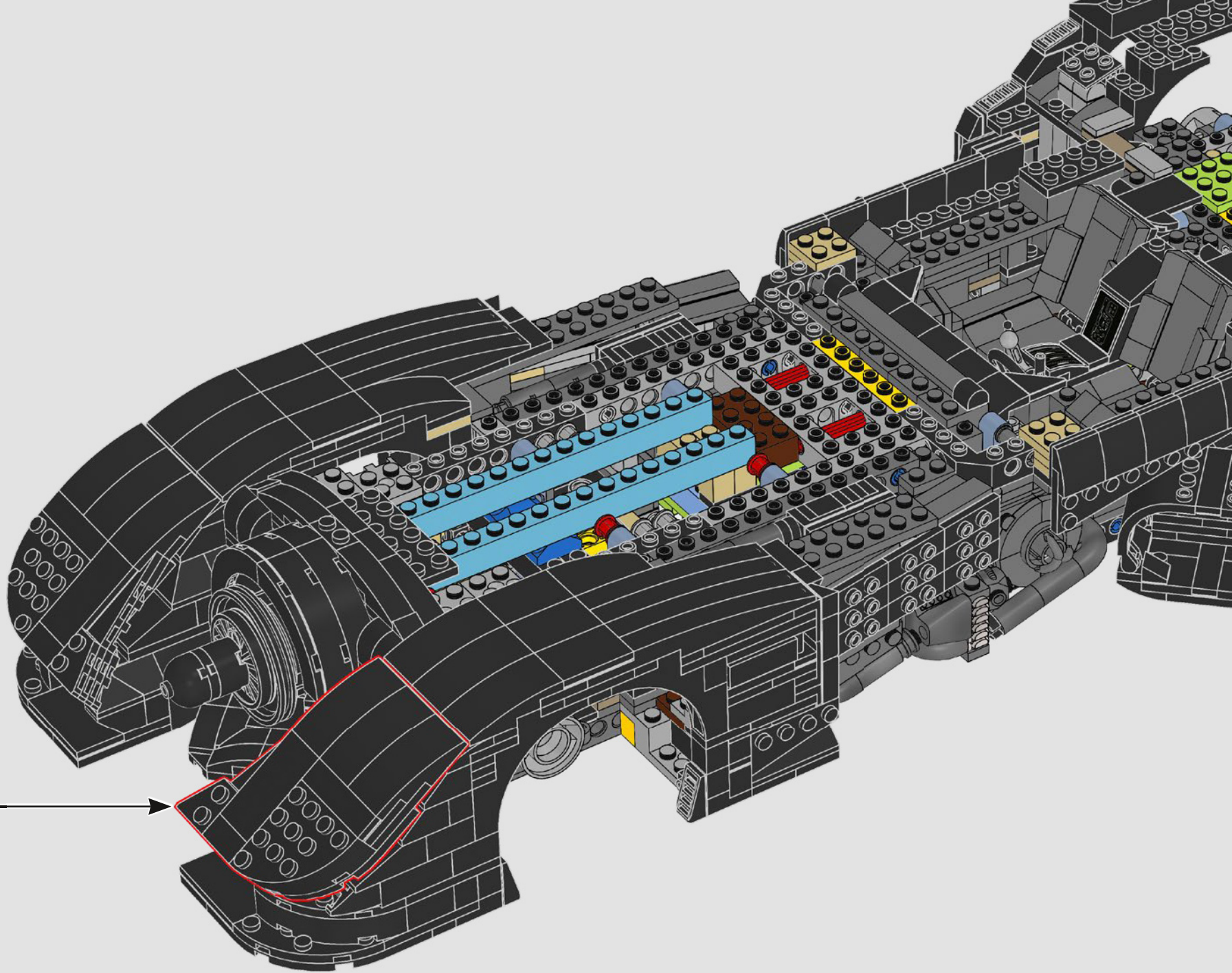



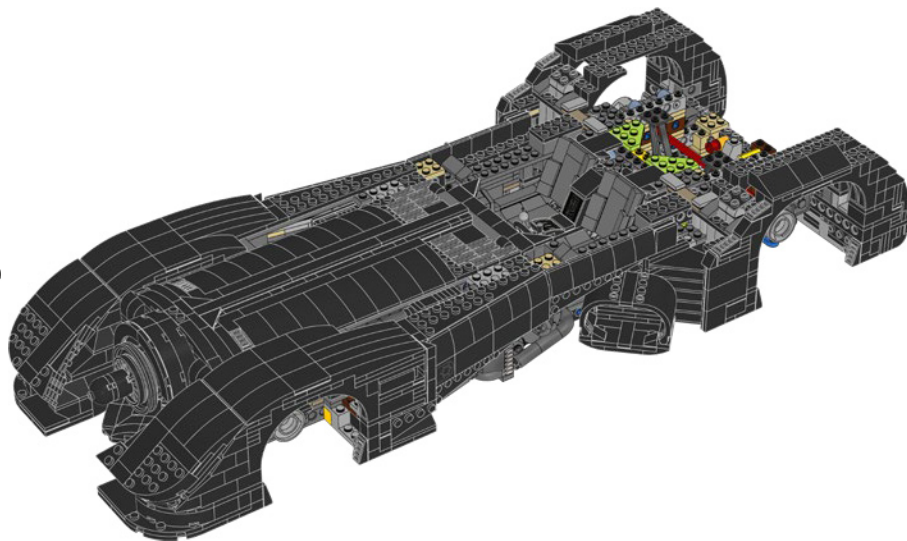
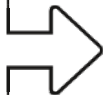

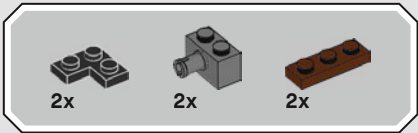

# 401

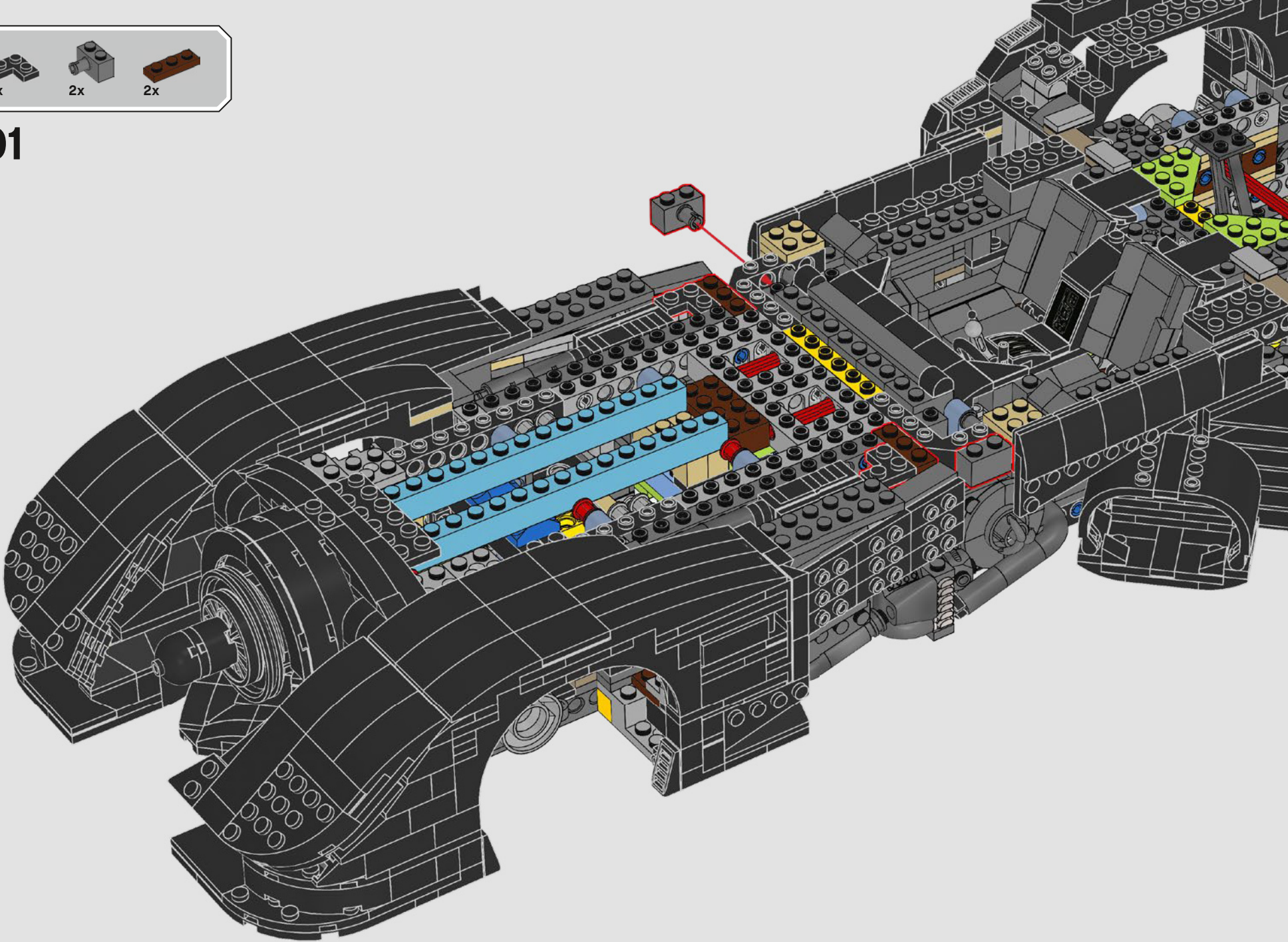

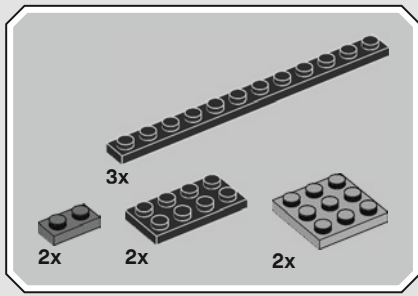

402

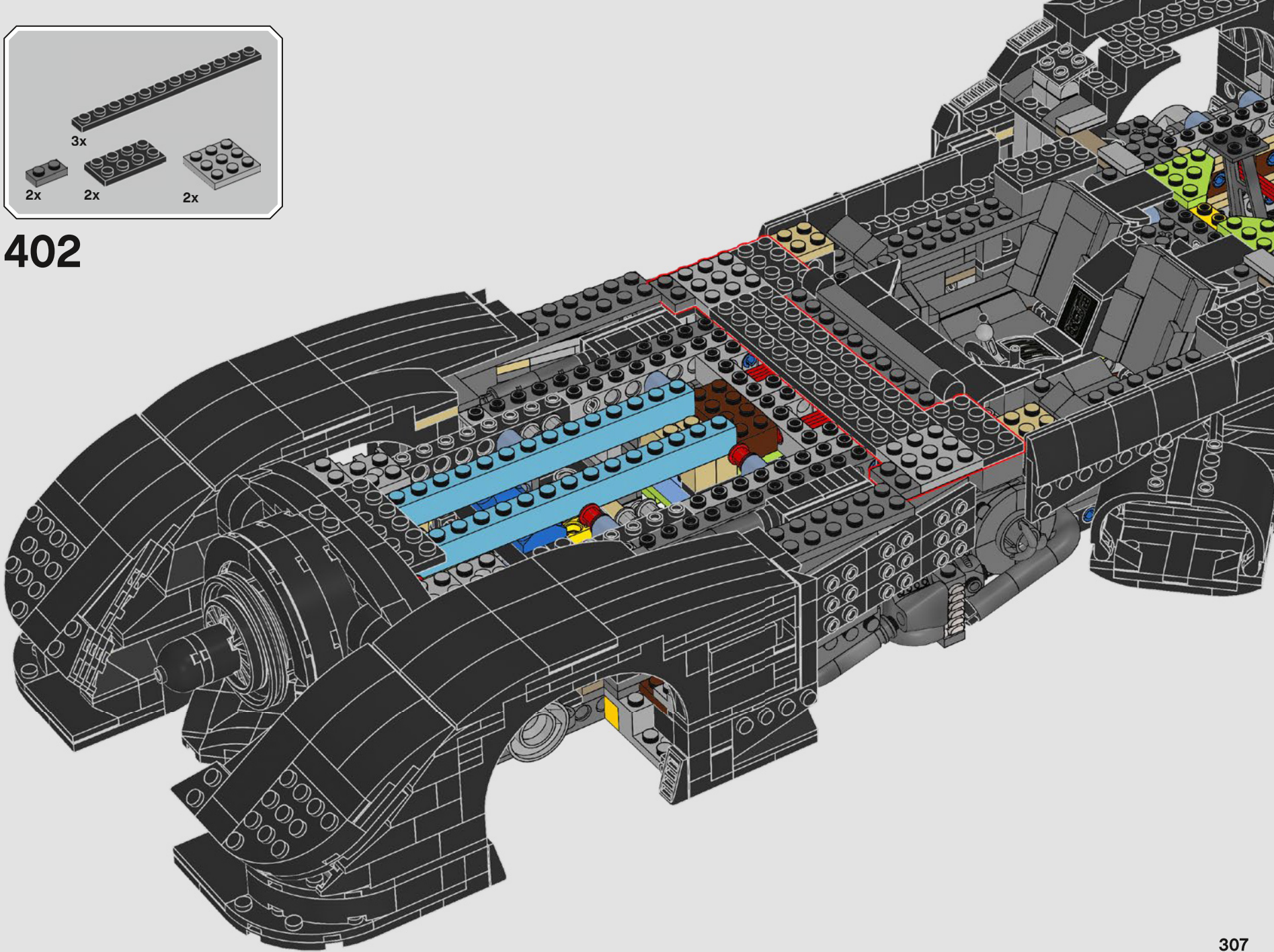

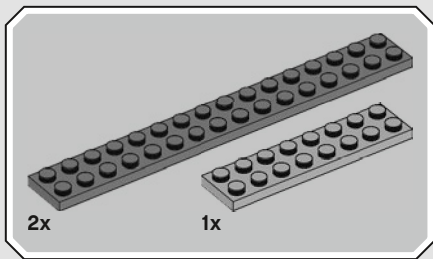

403

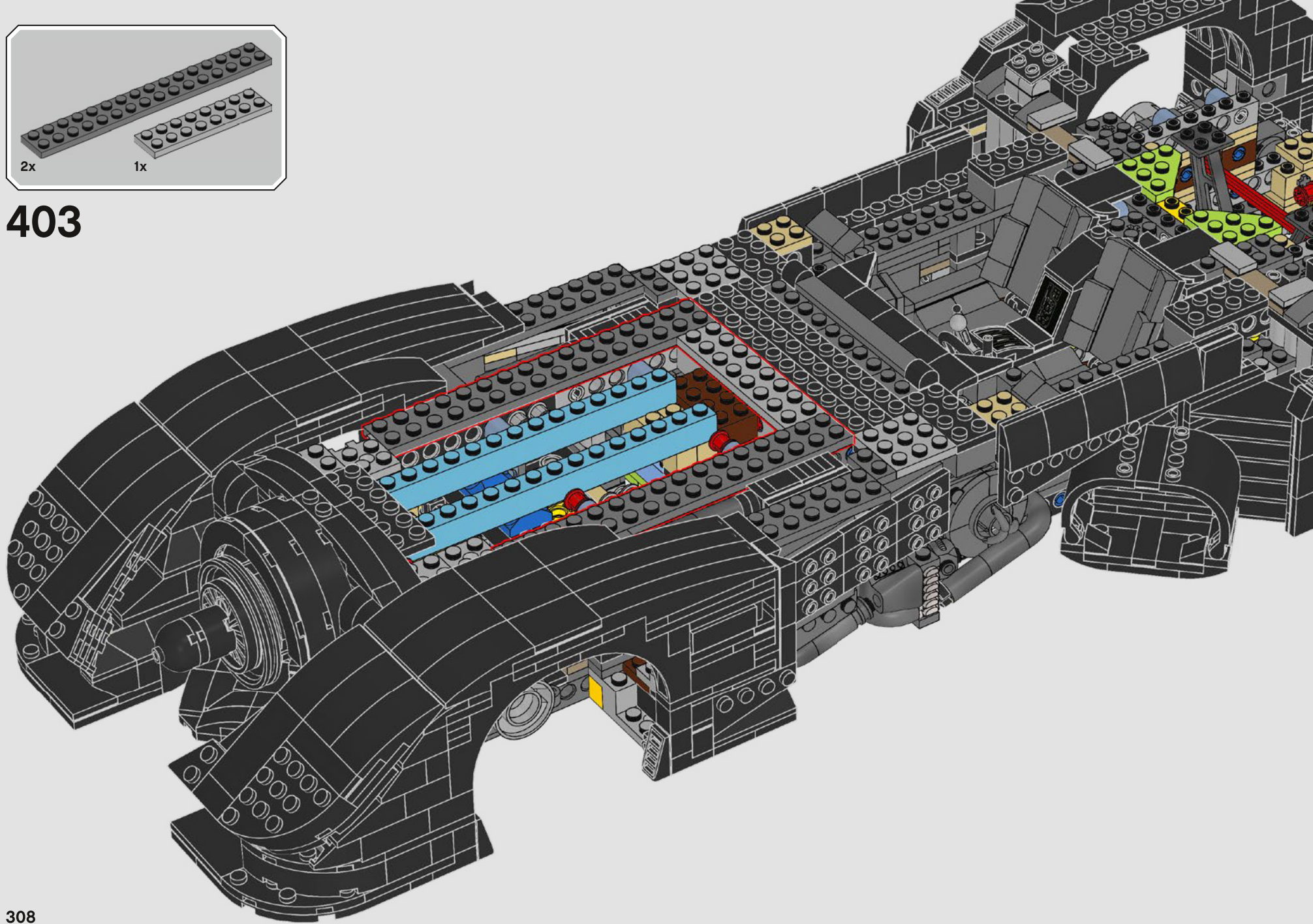

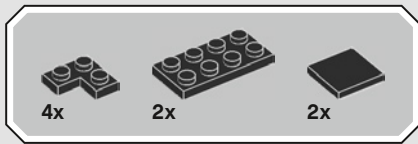

404

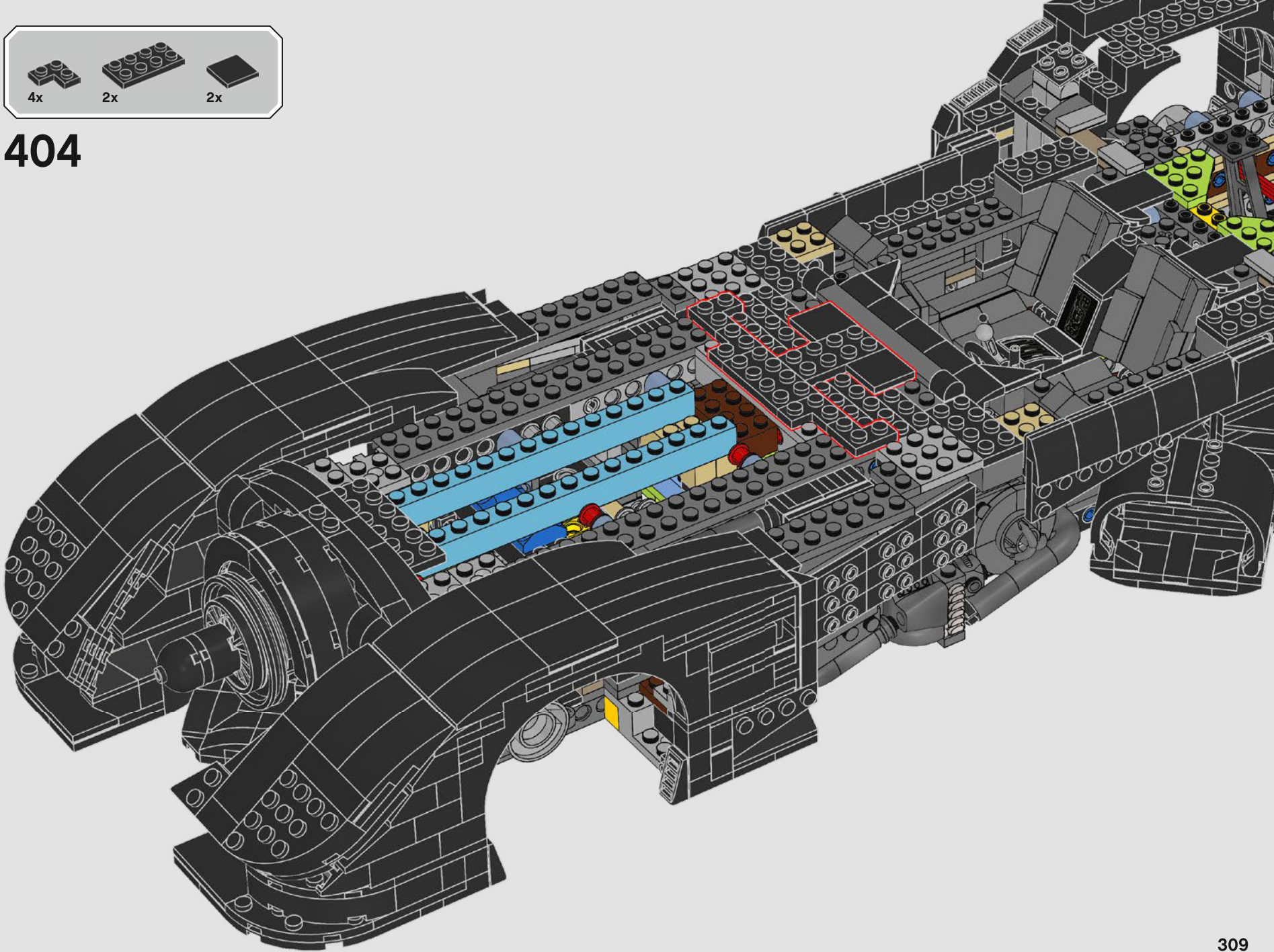



16x

405

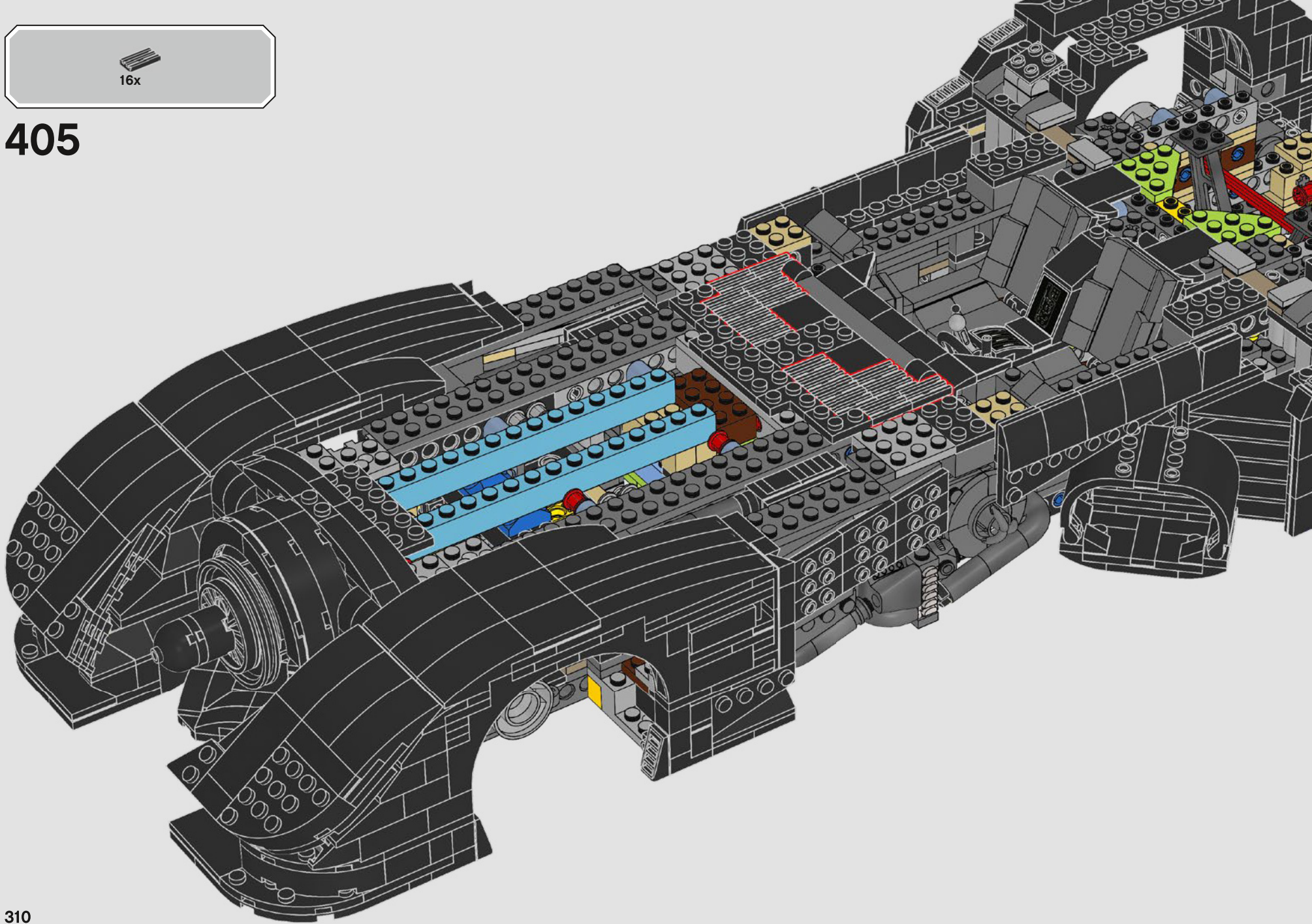

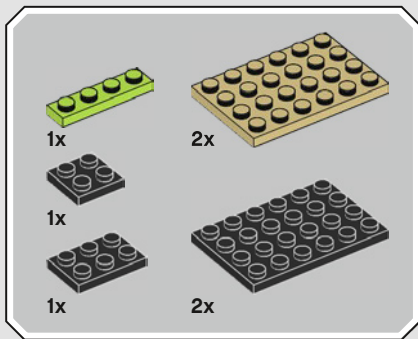

406

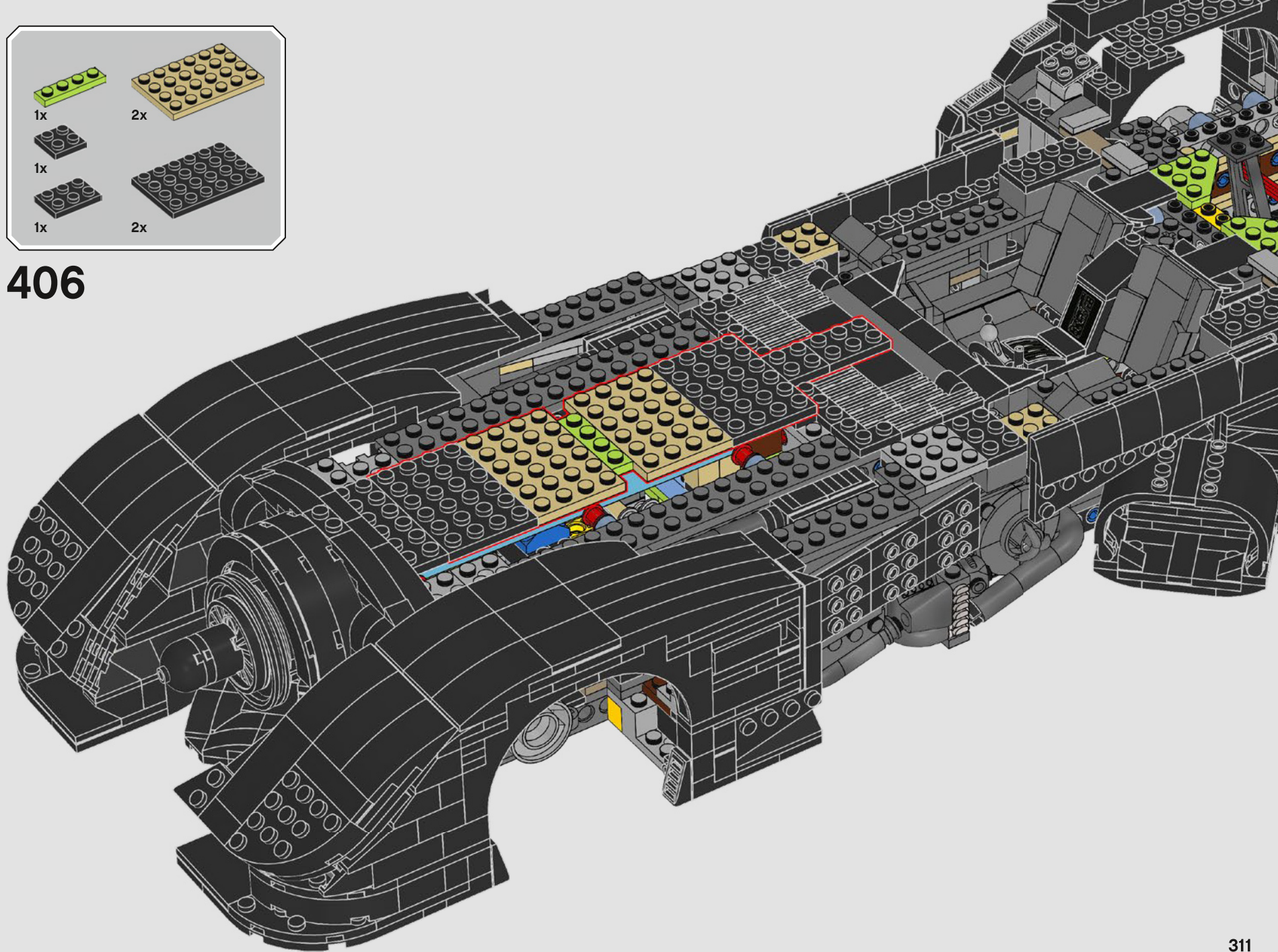

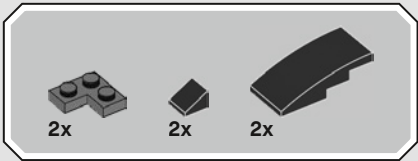

407

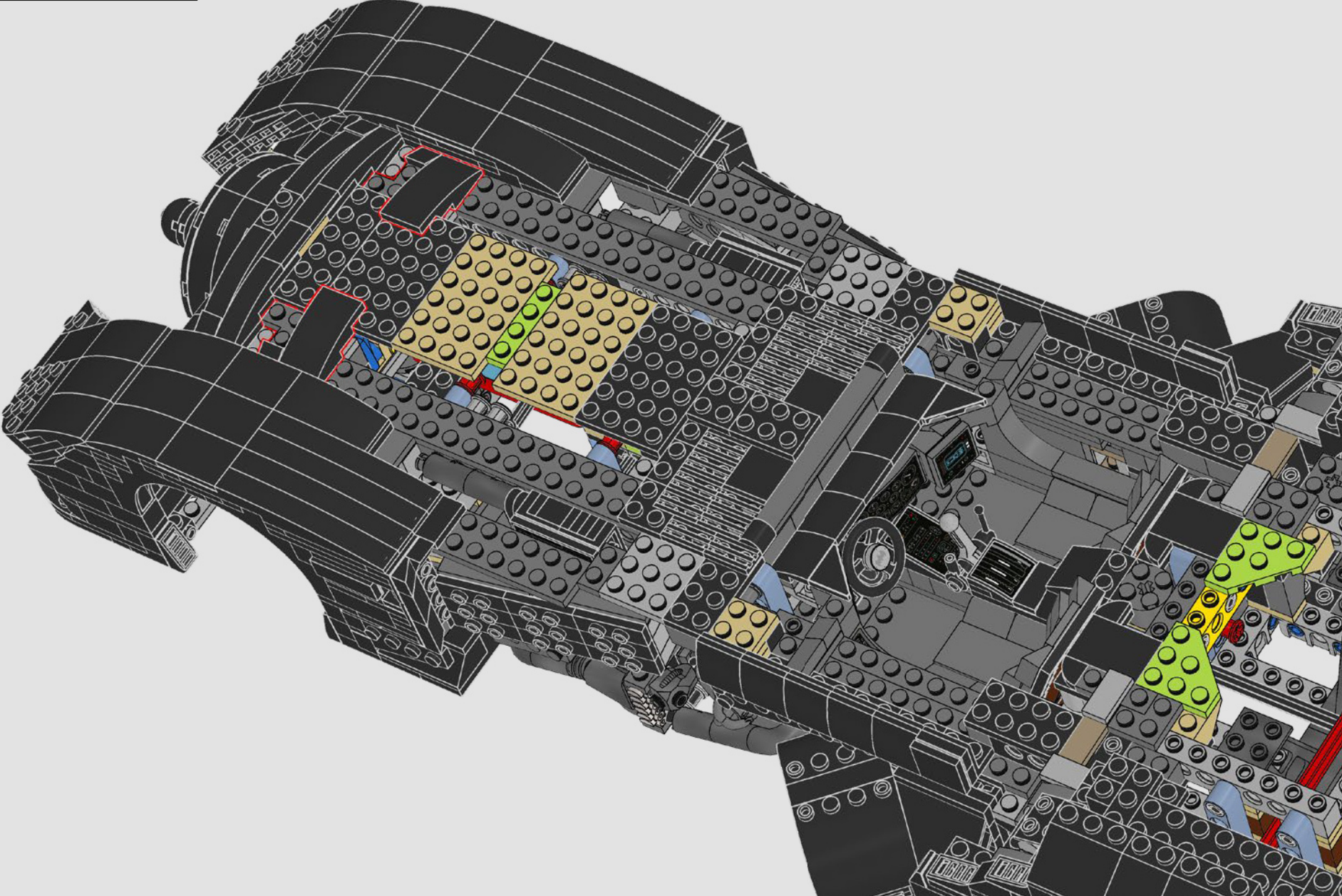



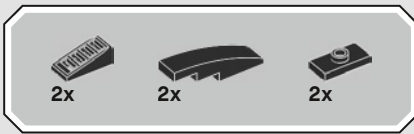

408

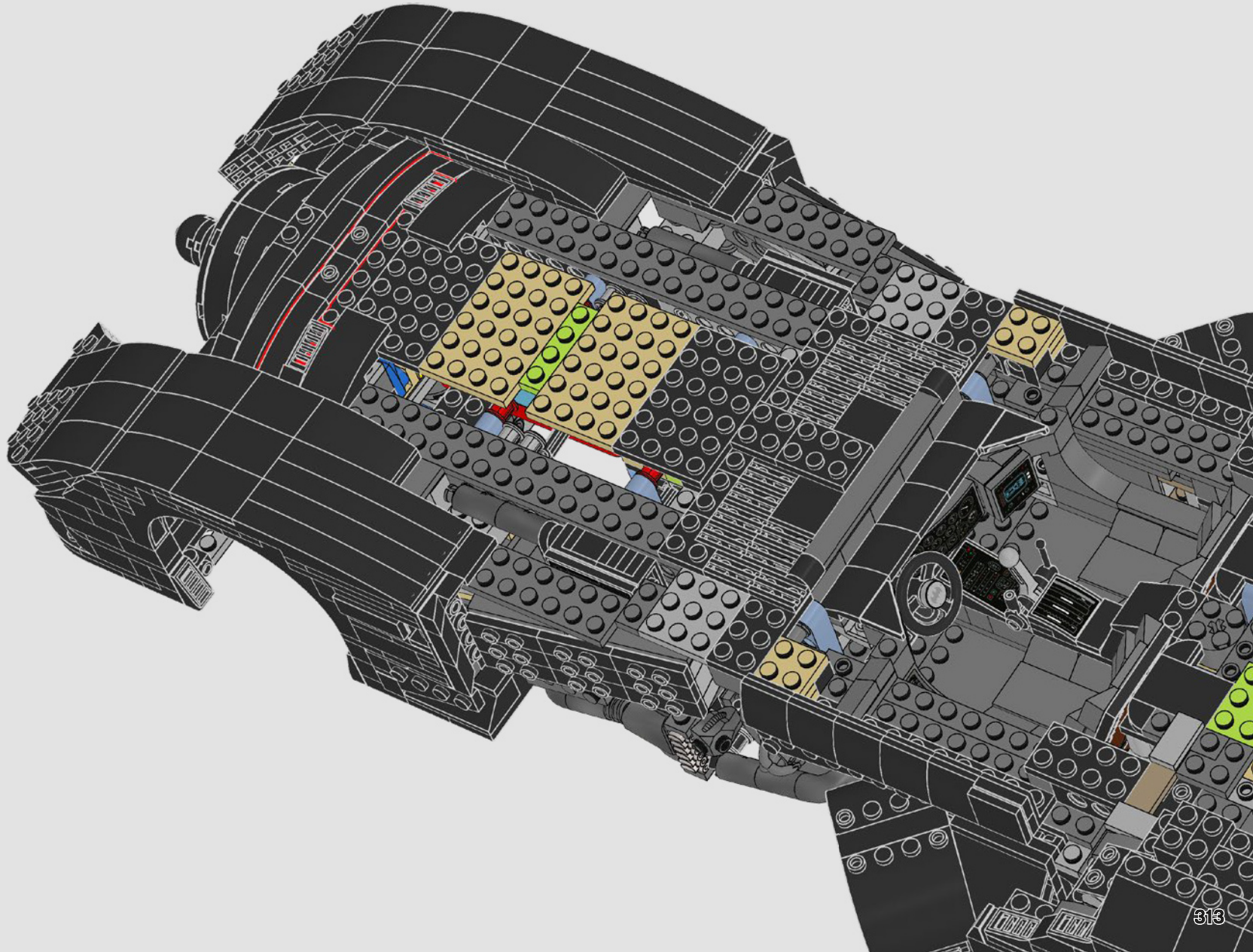

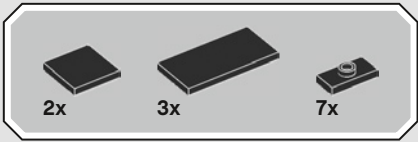

# 409

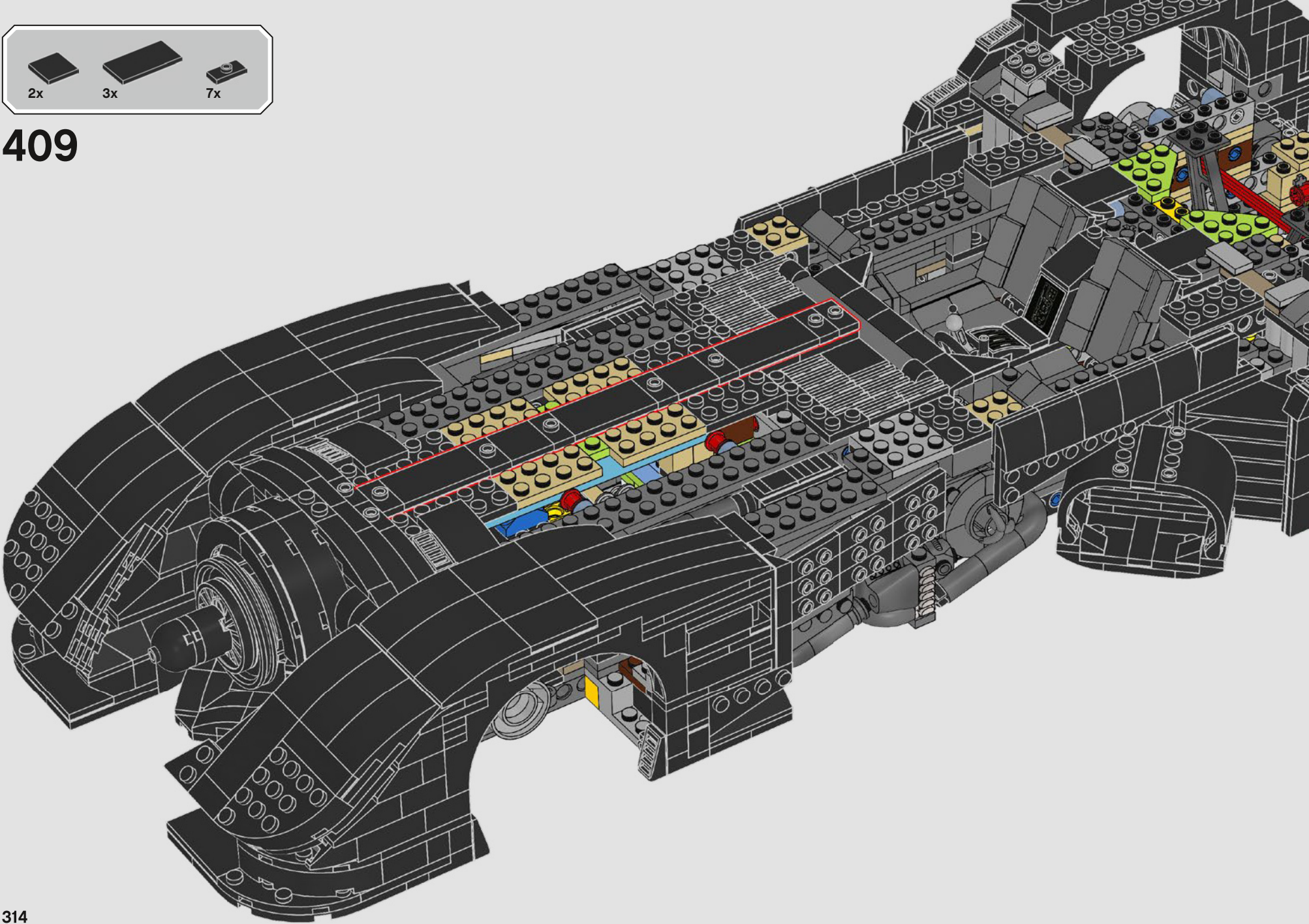

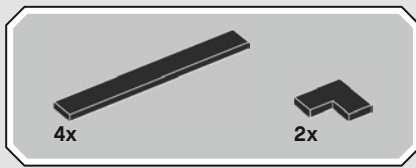

410

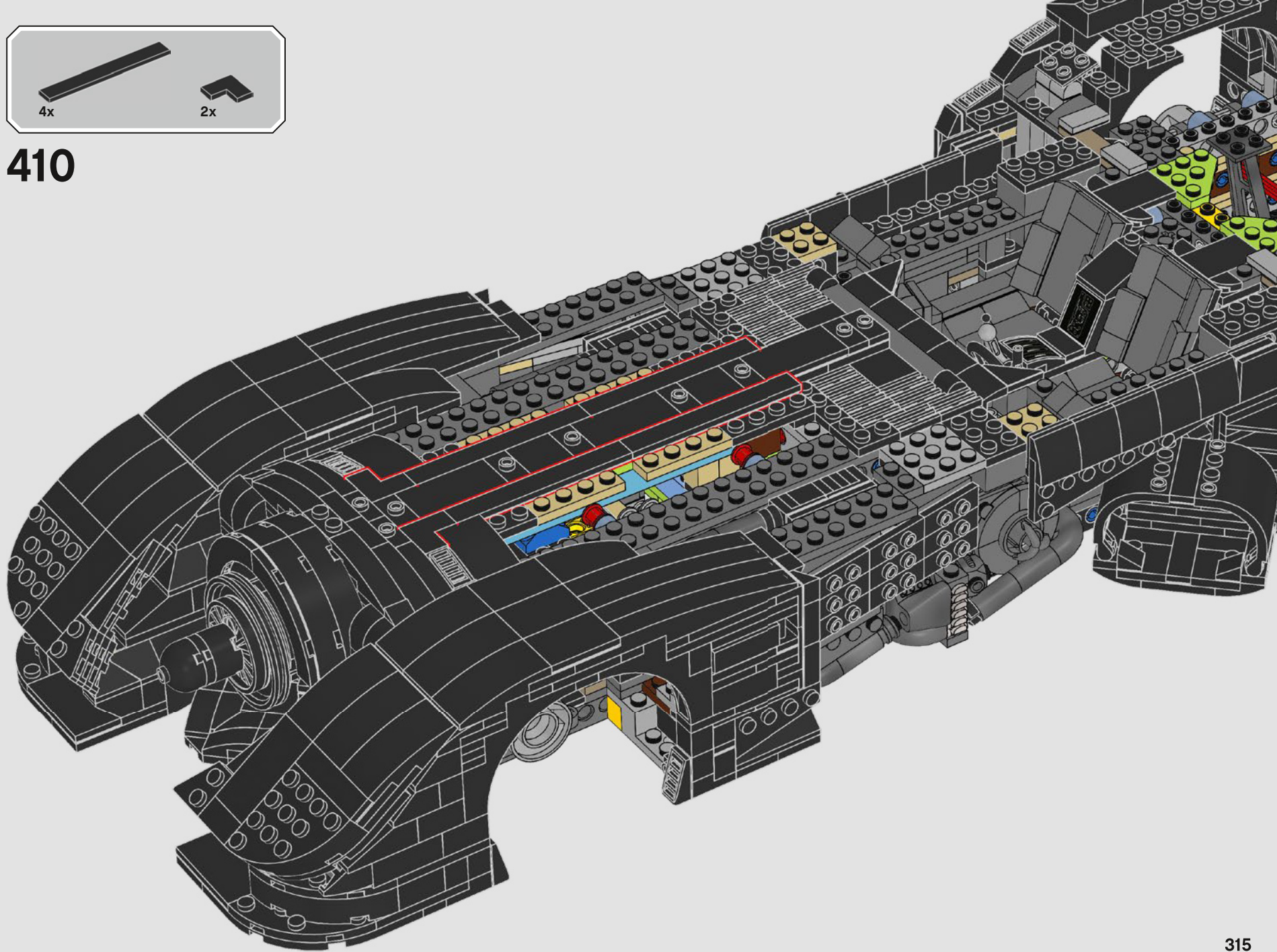

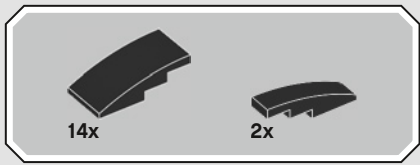

411

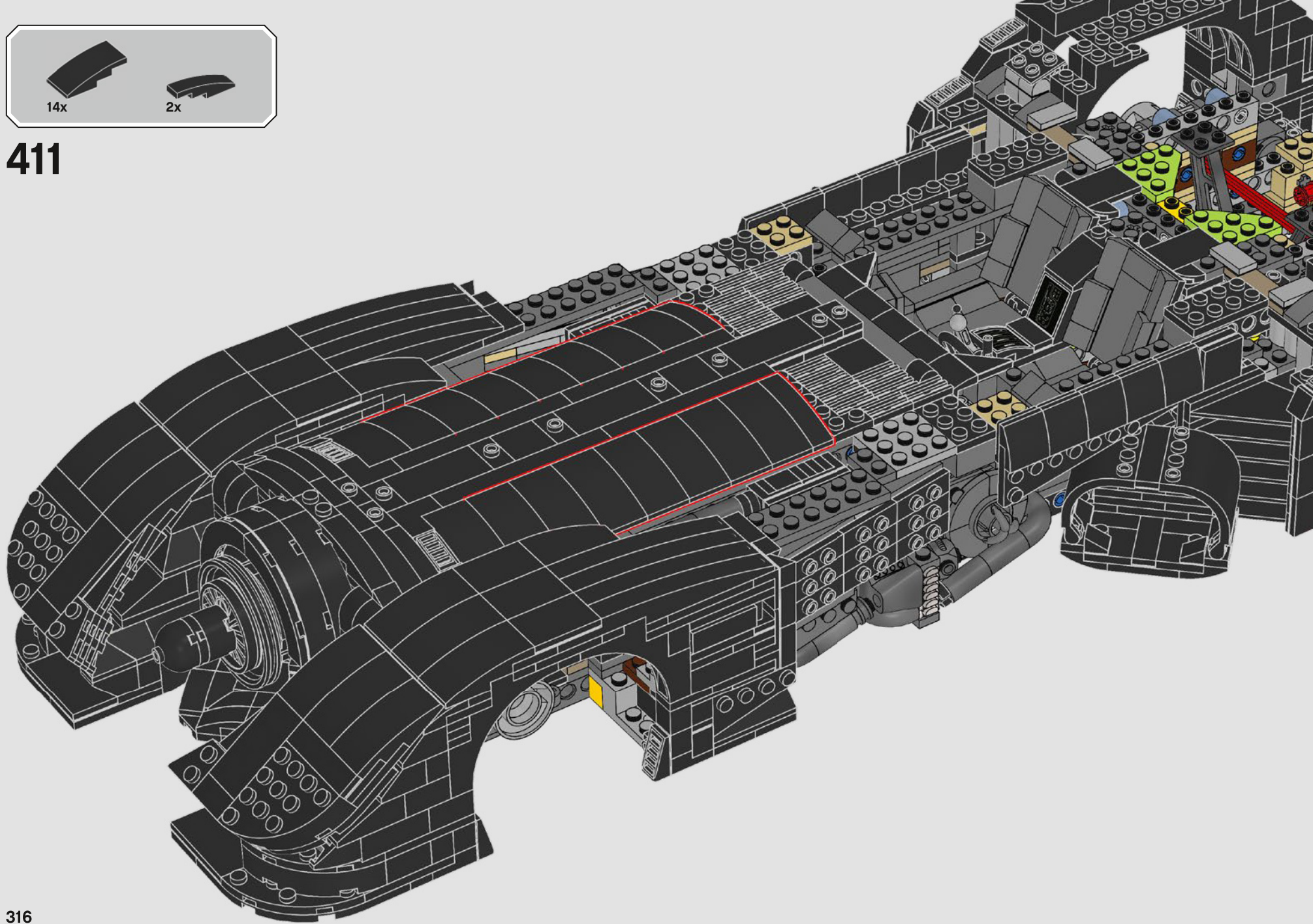

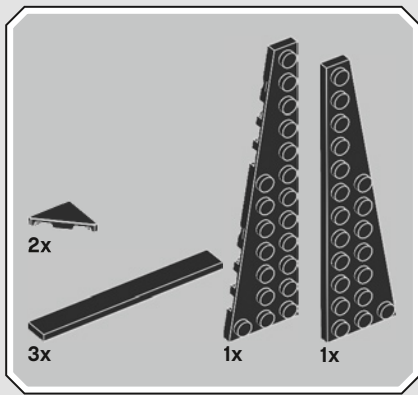

412

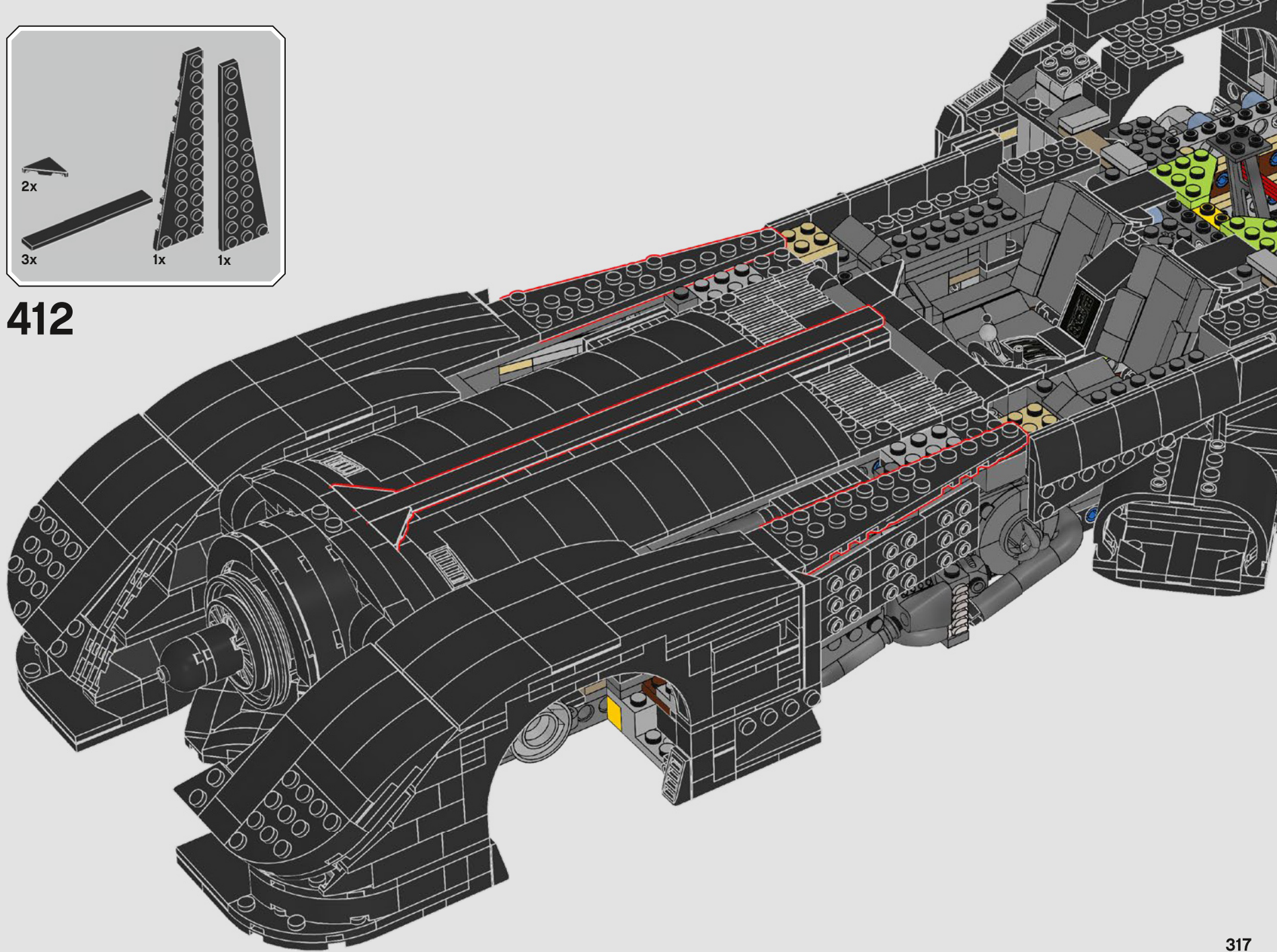

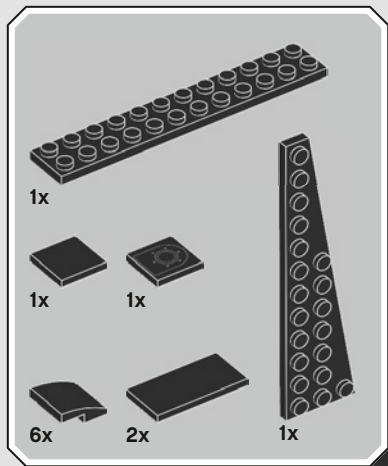

413

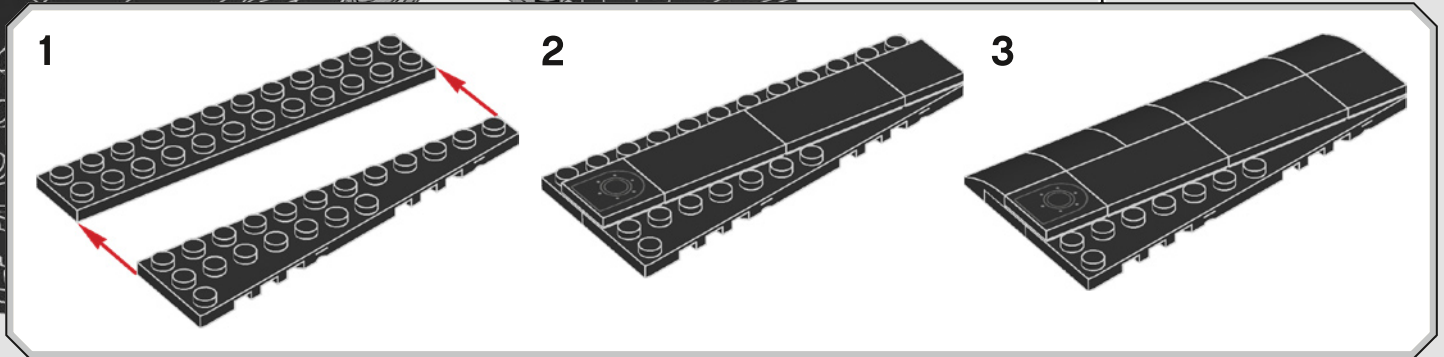
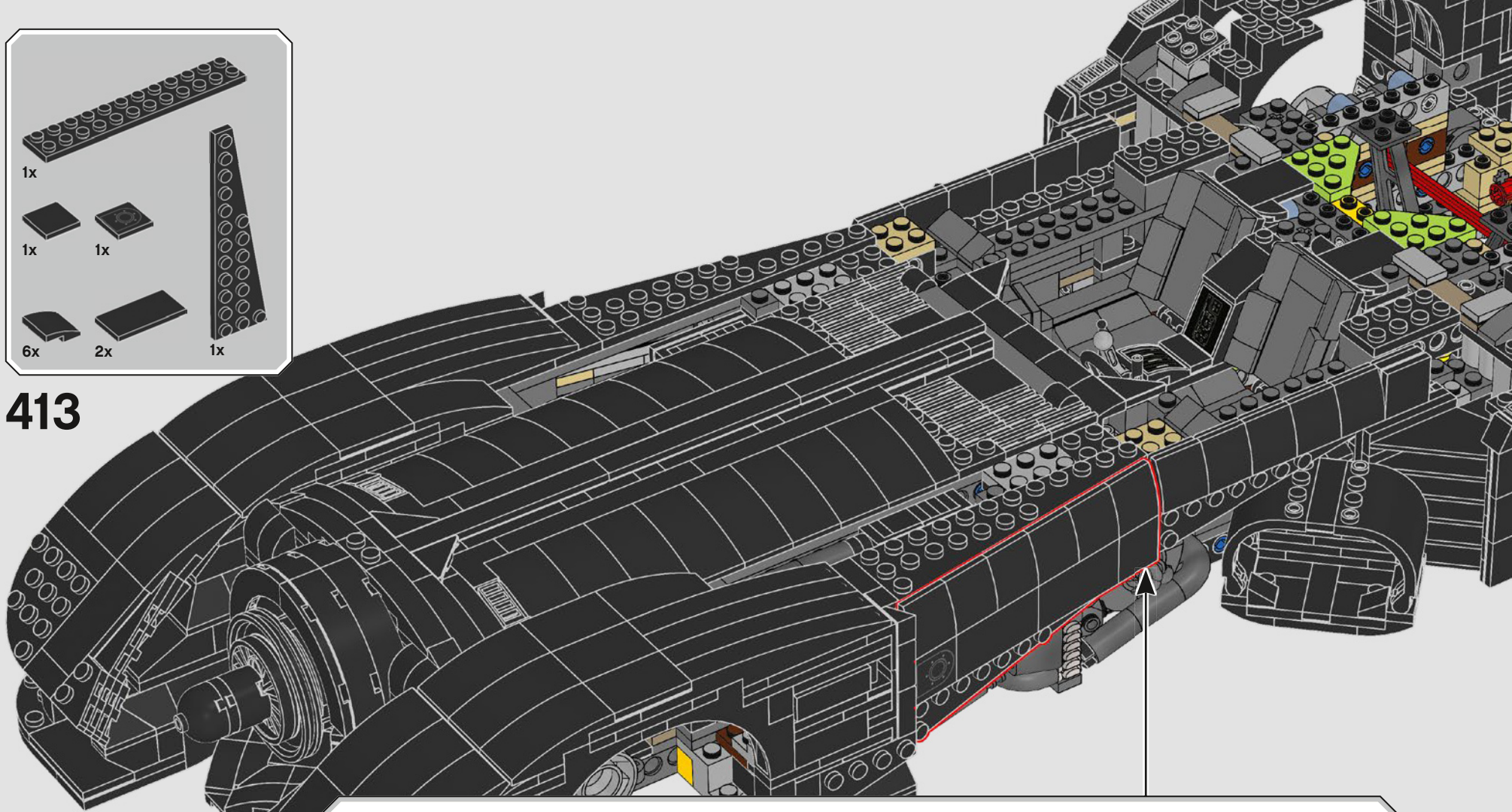

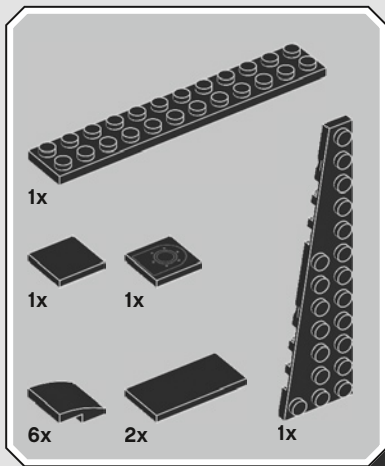

414

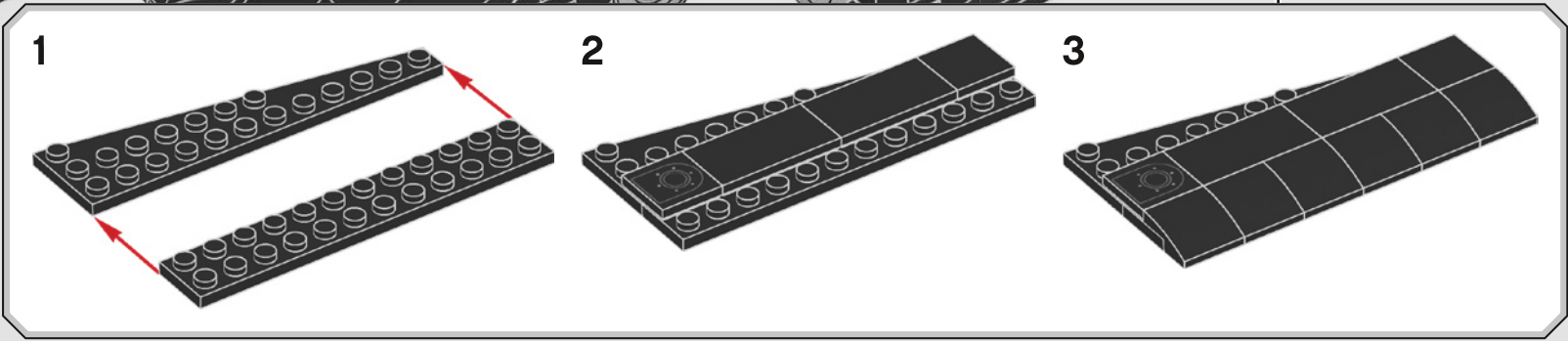
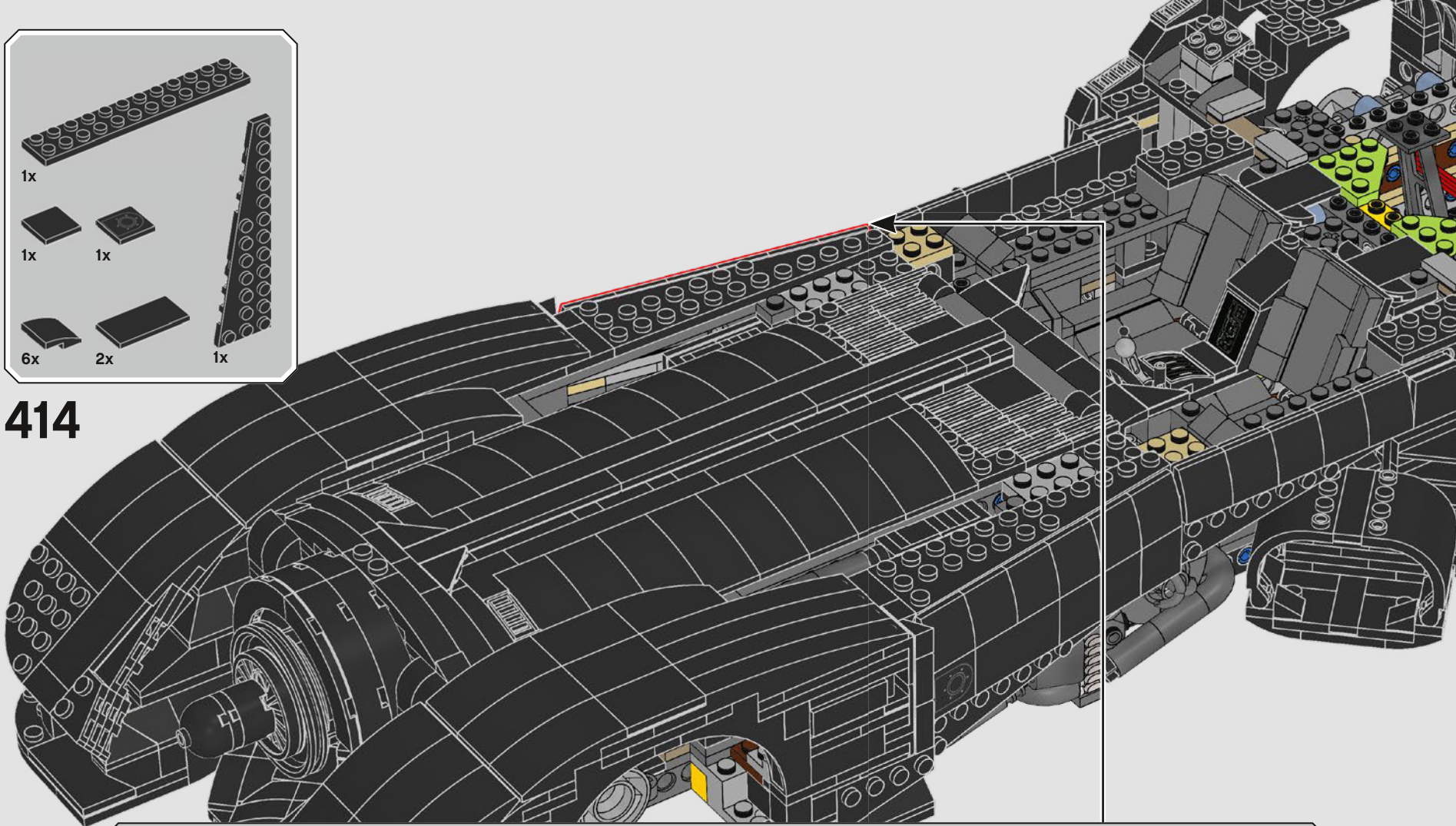

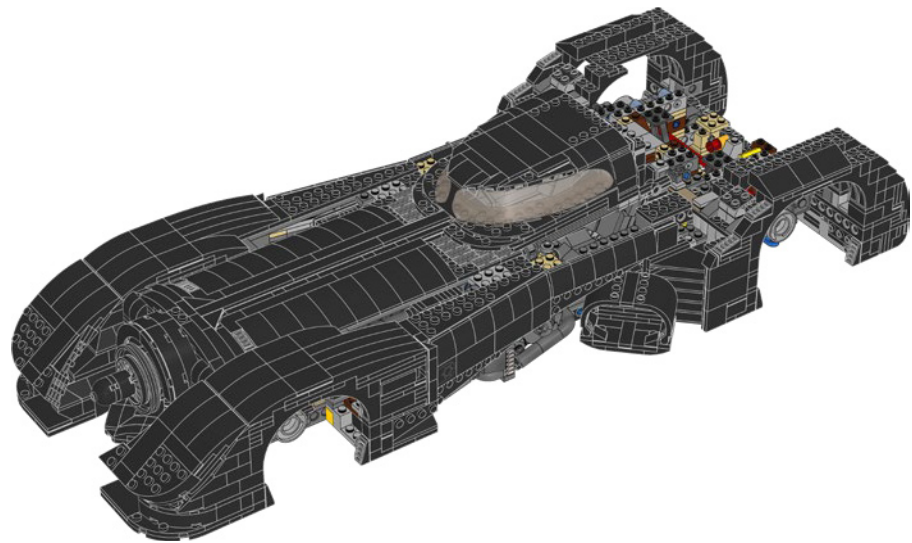
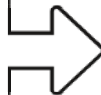



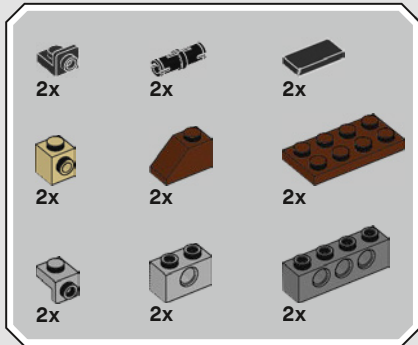

415

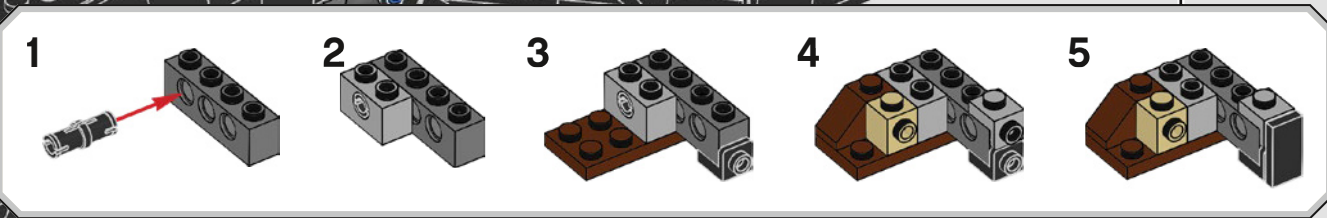
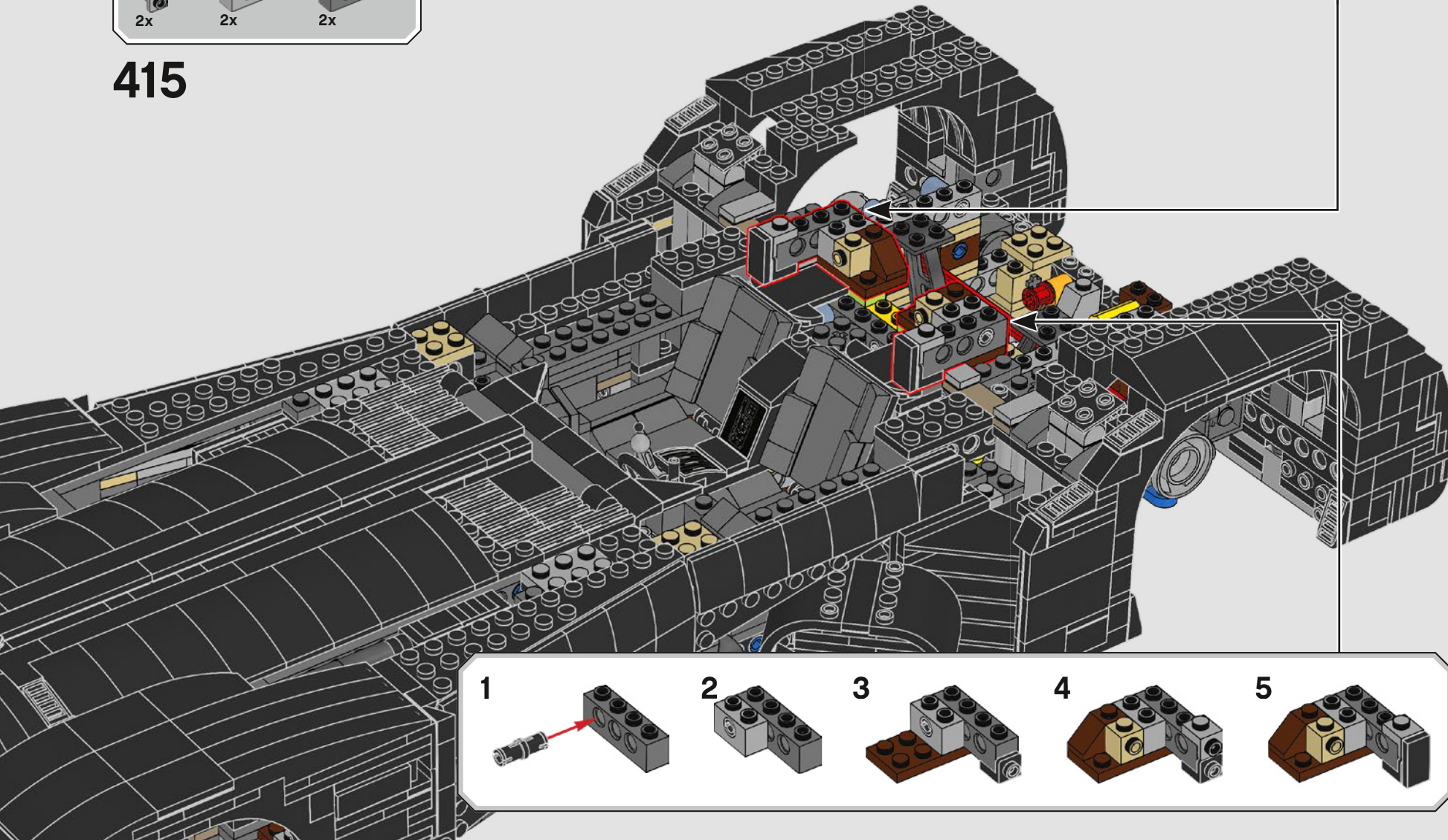
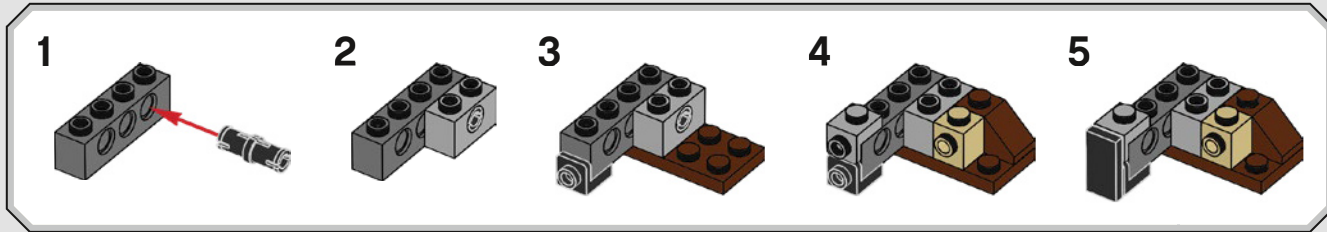

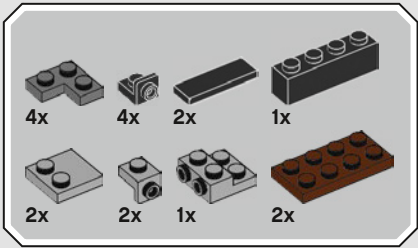

# 416

1

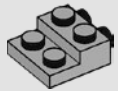

2

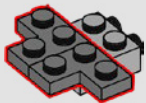

3

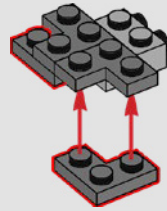

4

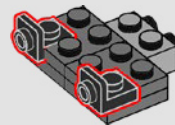

5

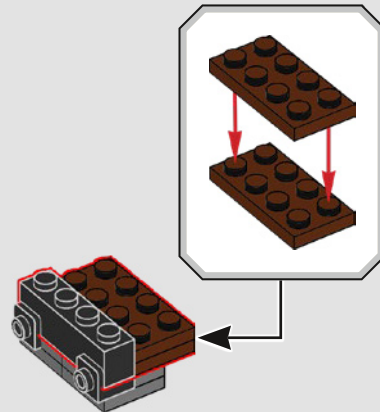

6

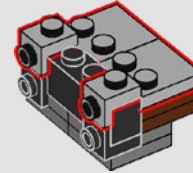

7

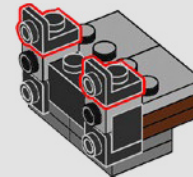

8

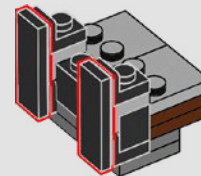

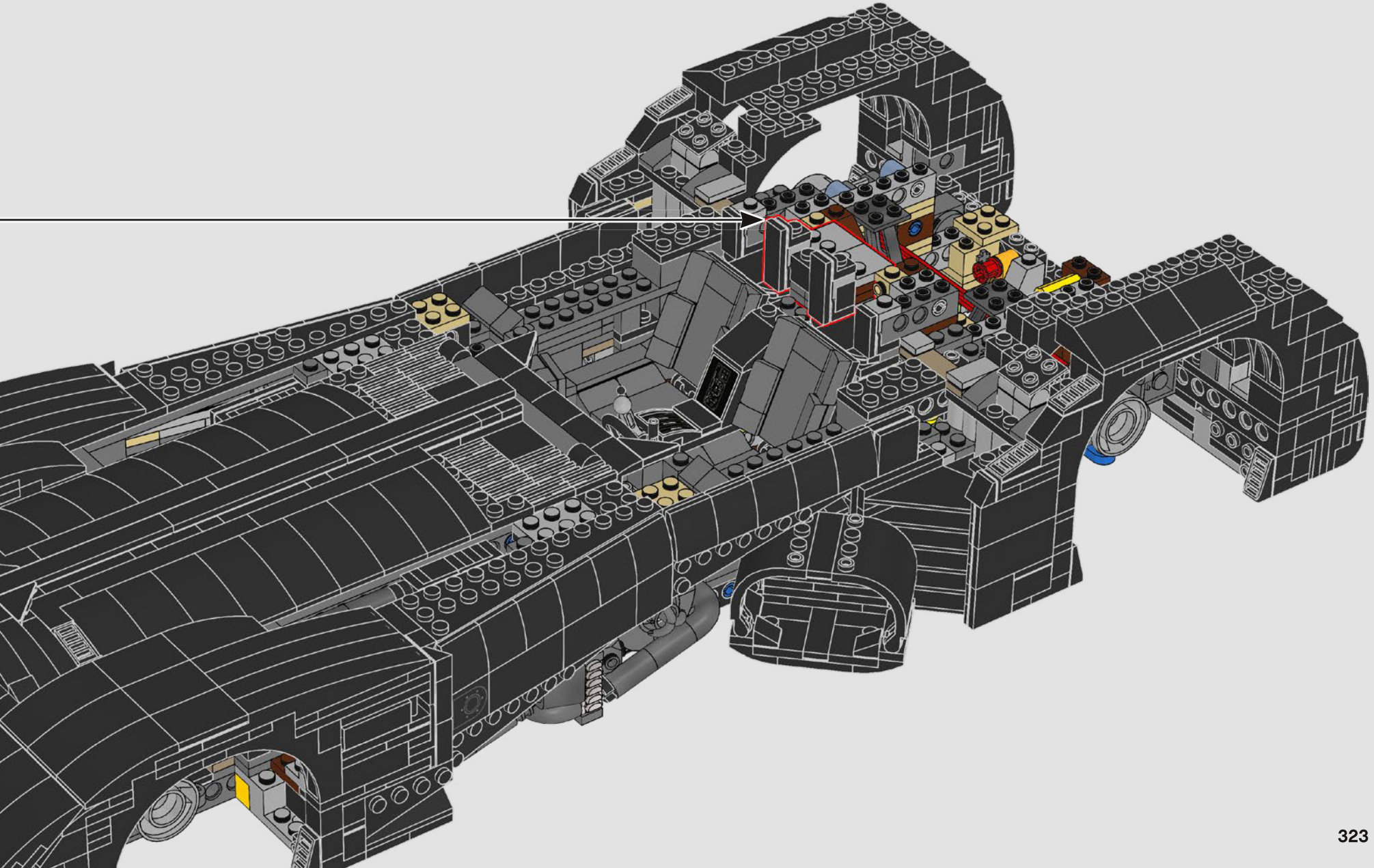

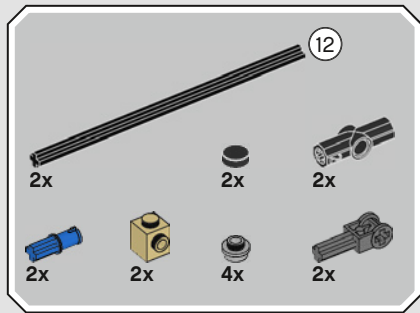

417

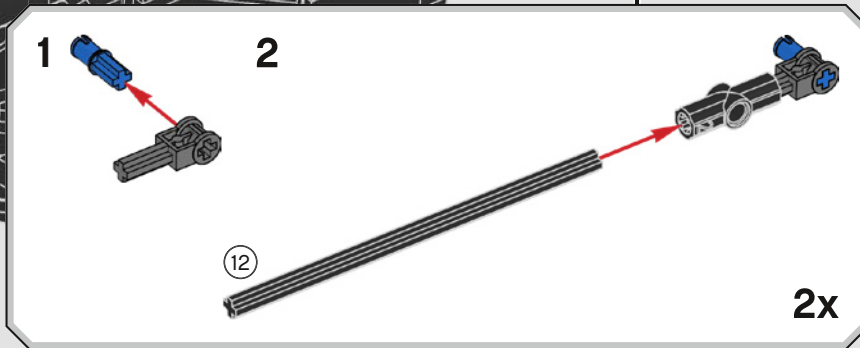
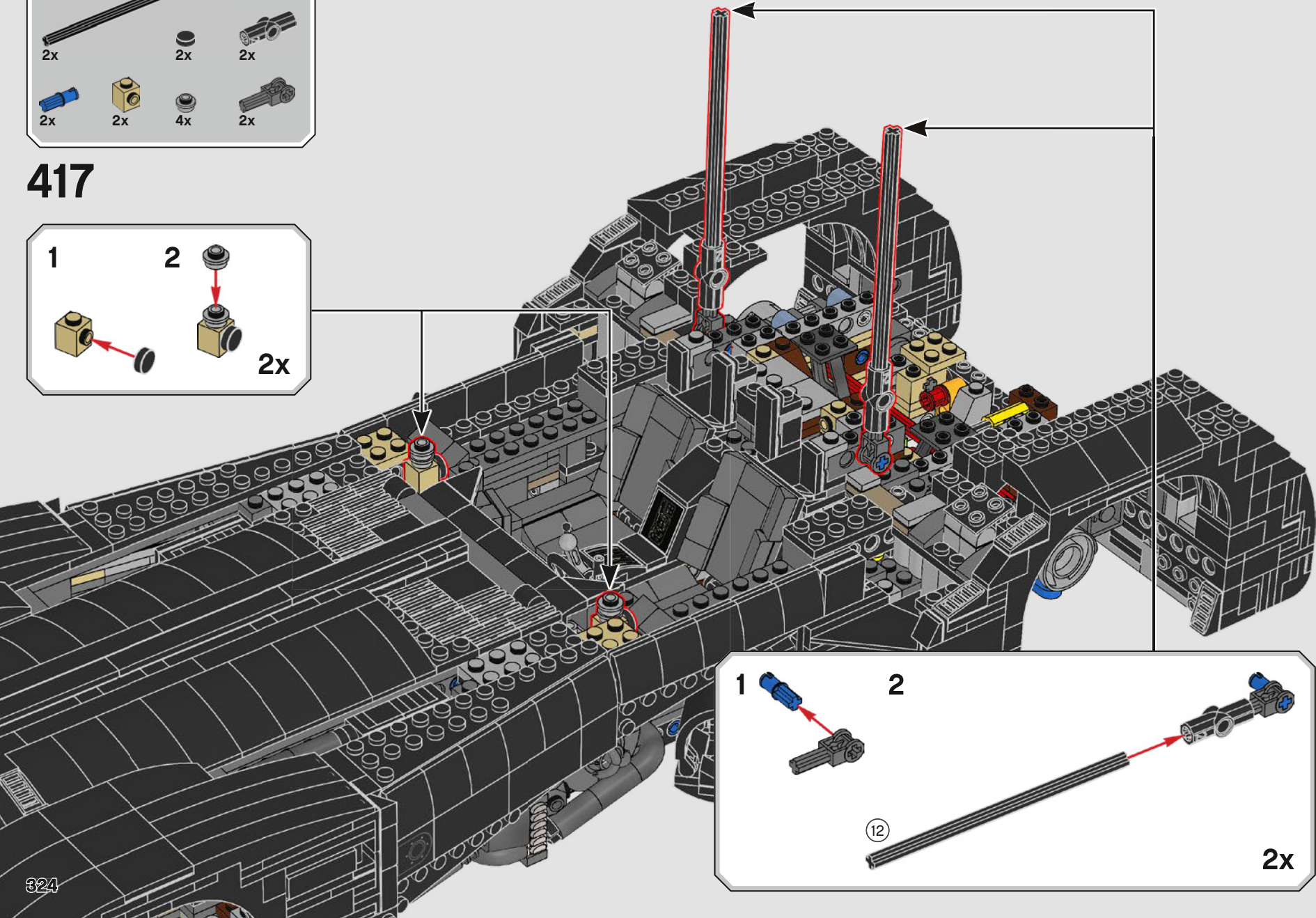
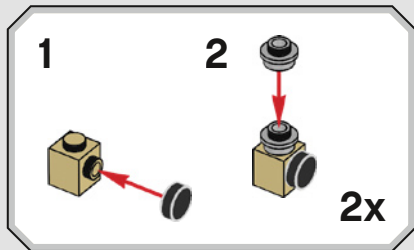

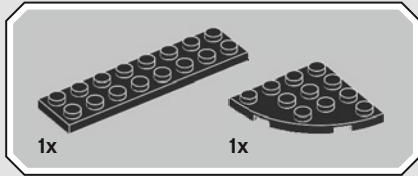
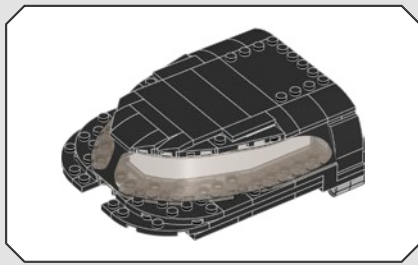

418

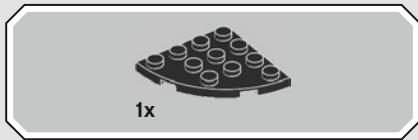
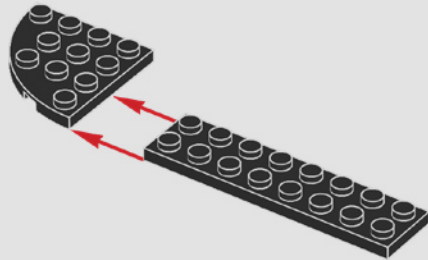

419

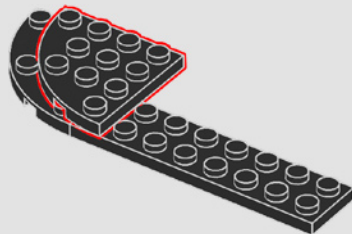

420

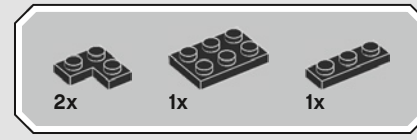
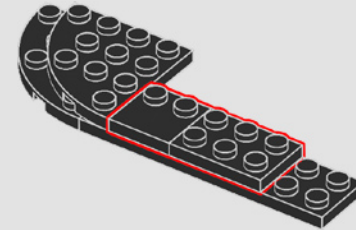

421

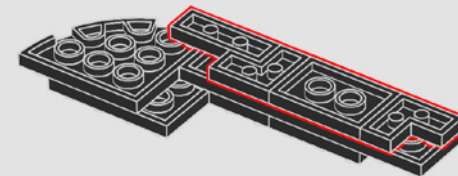

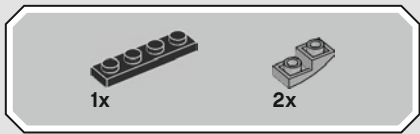

422

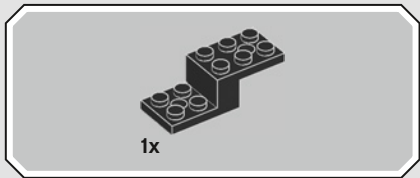
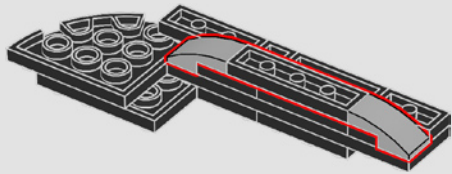

423

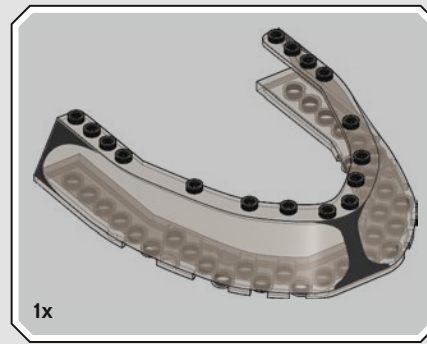
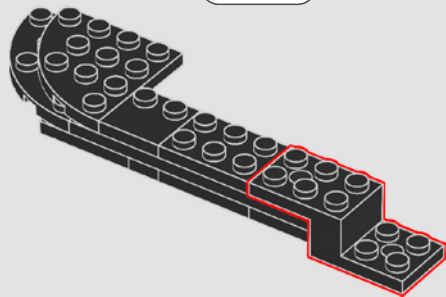

424

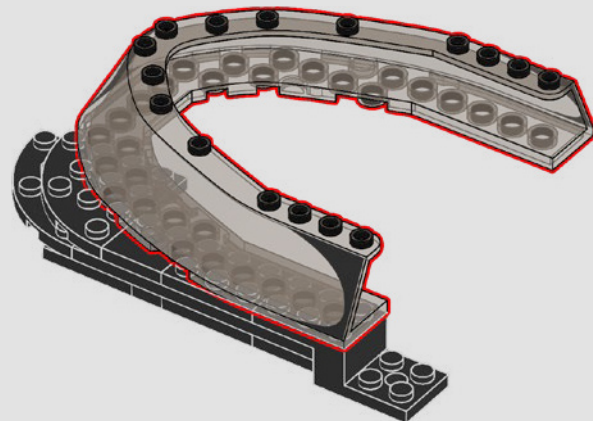

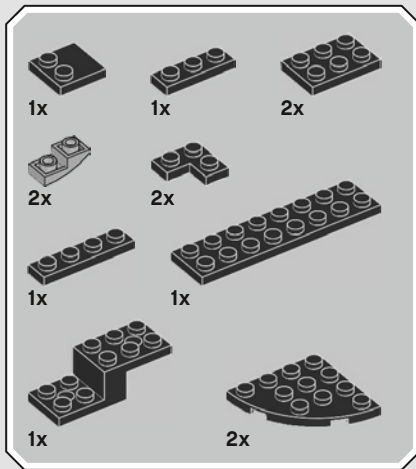

425

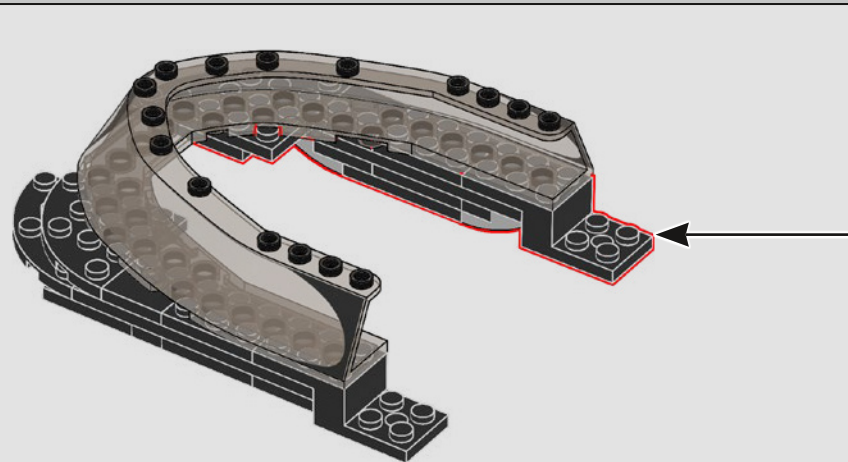
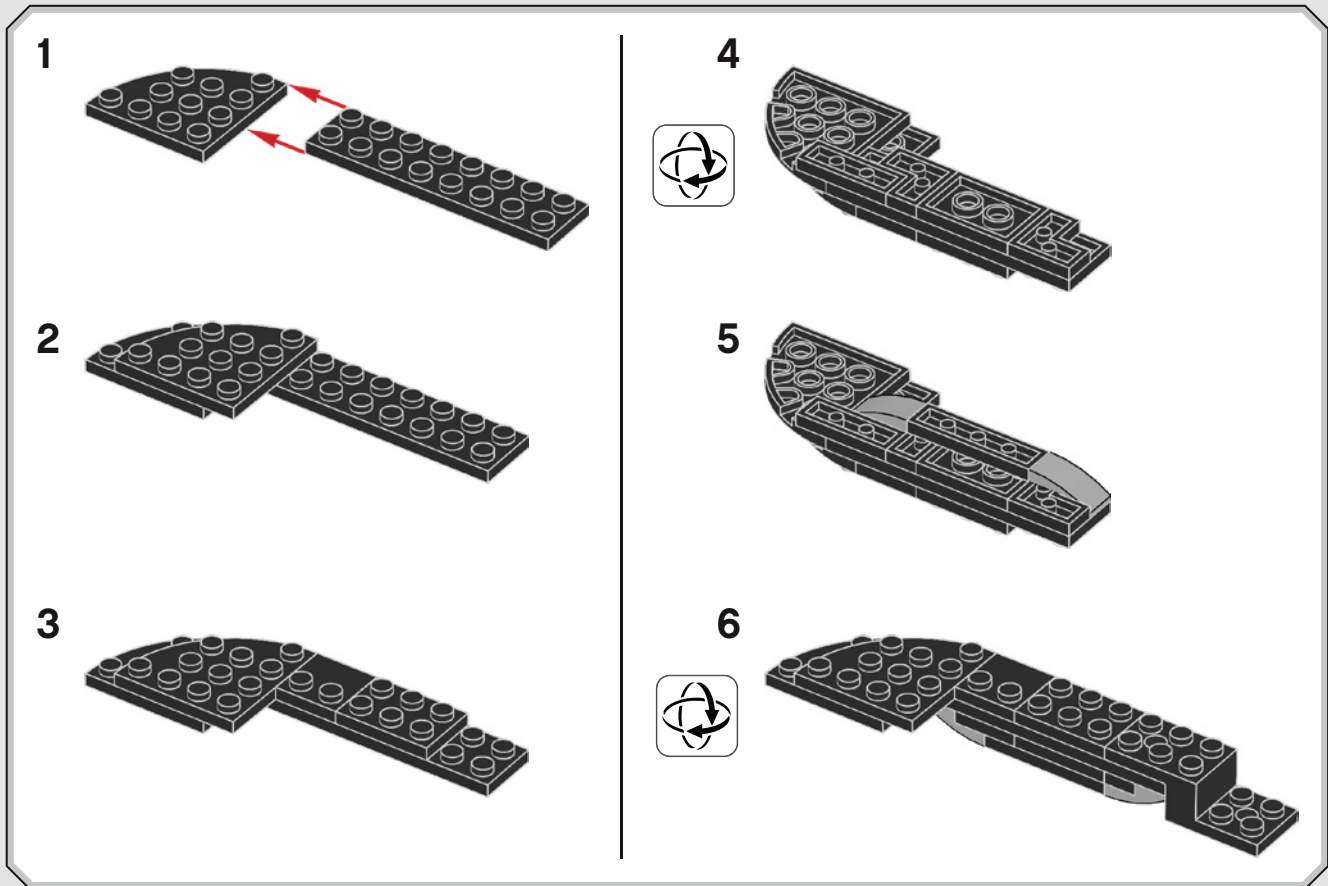



2x

# 426

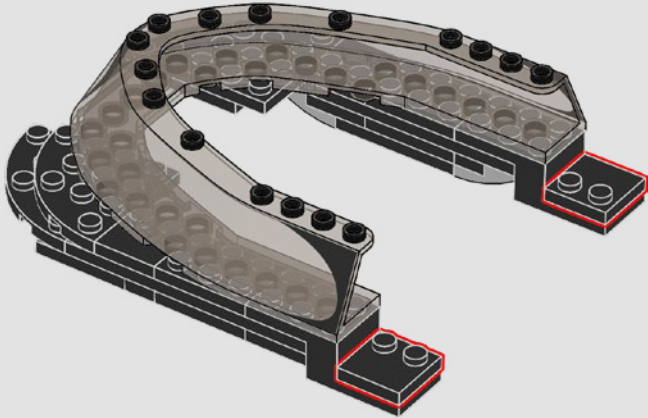

4x

# 427

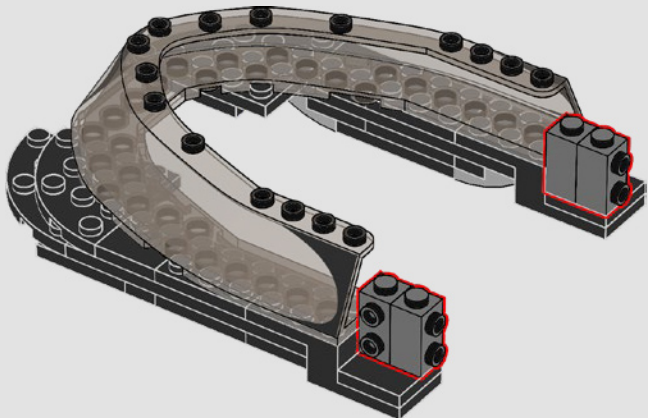

2x

# 428

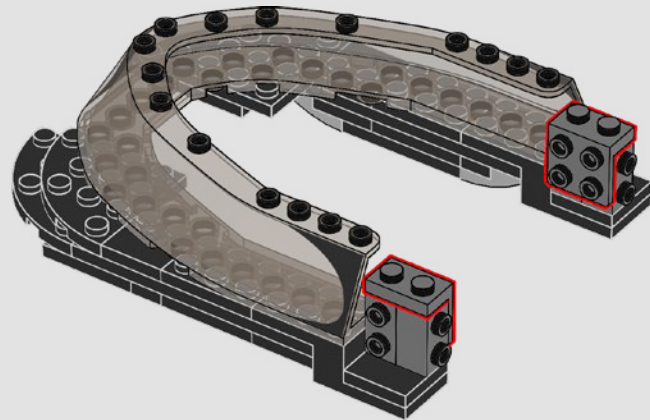





429

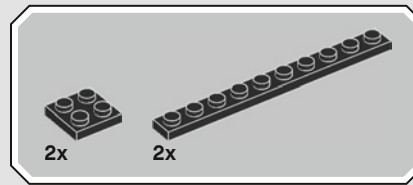
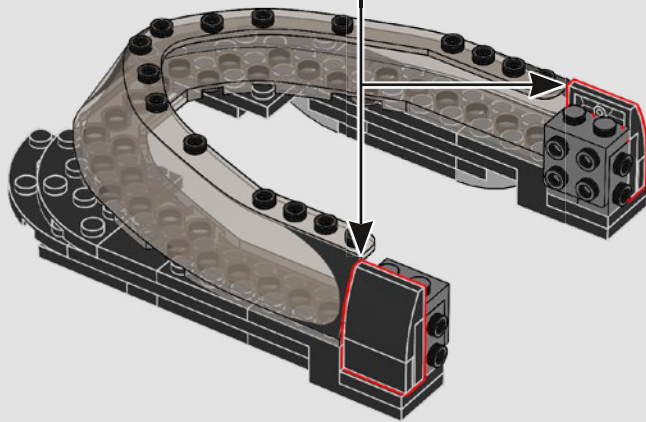
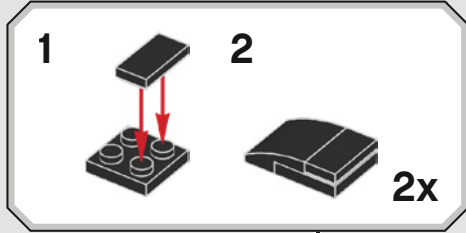

430

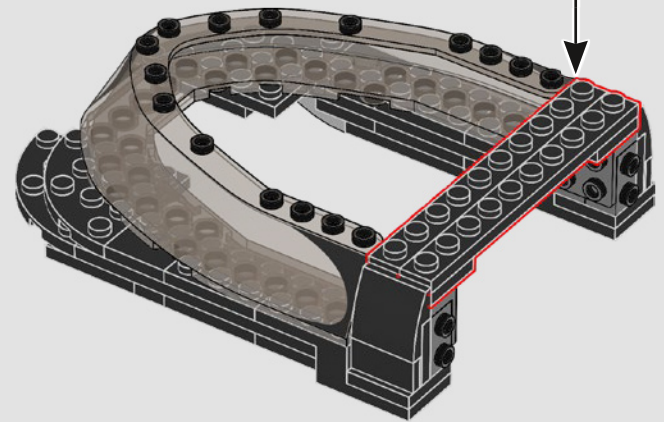
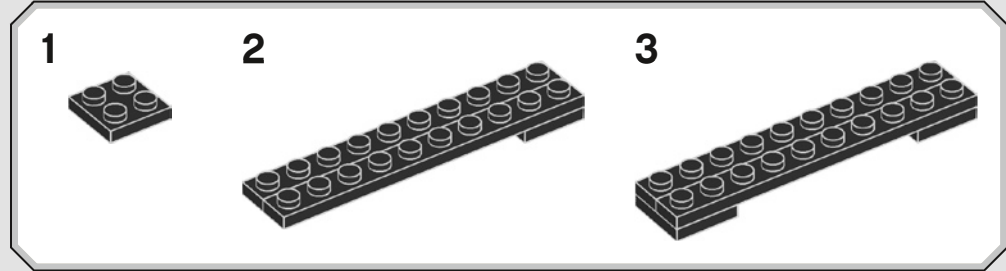

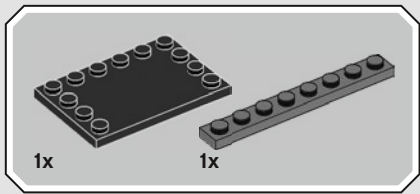

431

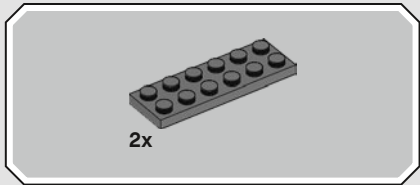
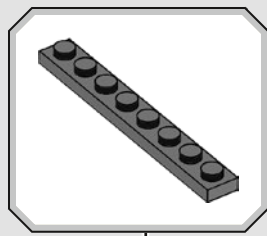
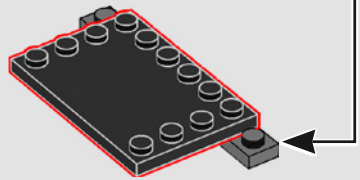

432

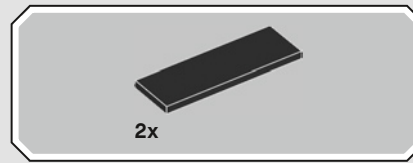
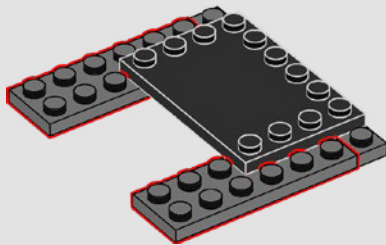

433

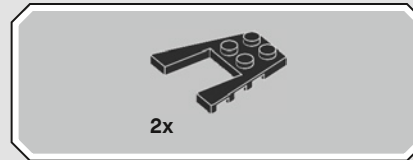
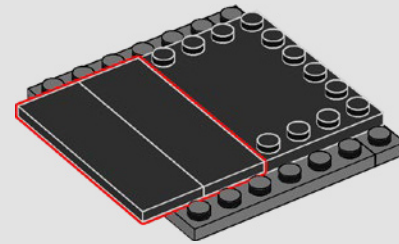

434

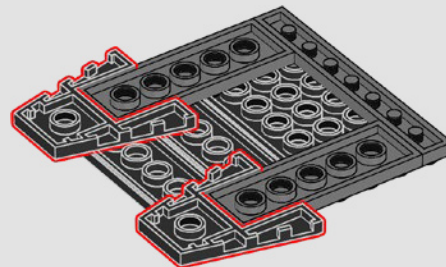

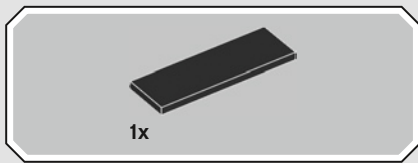

435

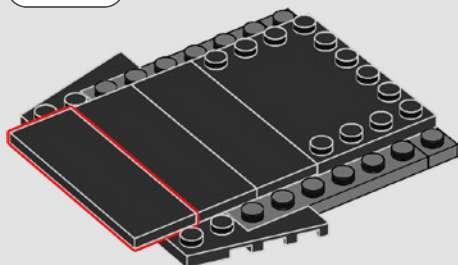

436

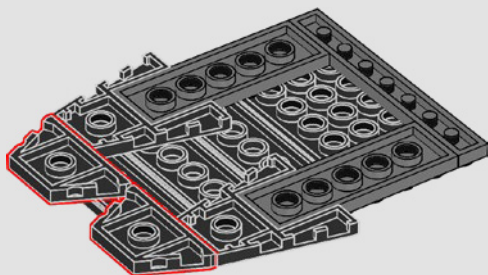

437

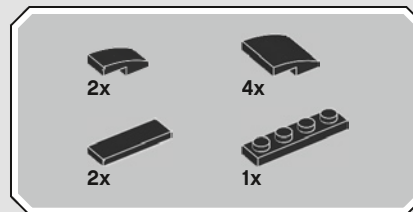
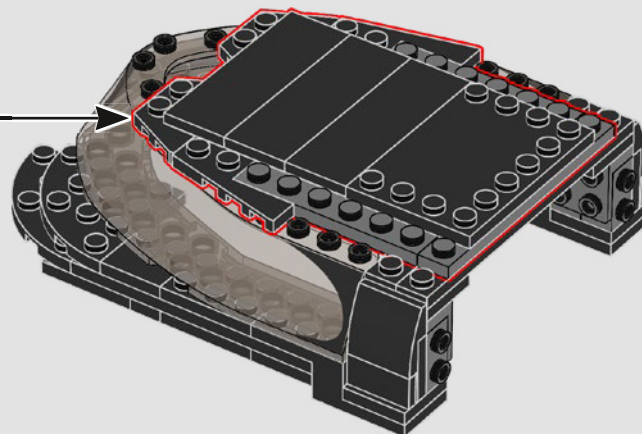

438

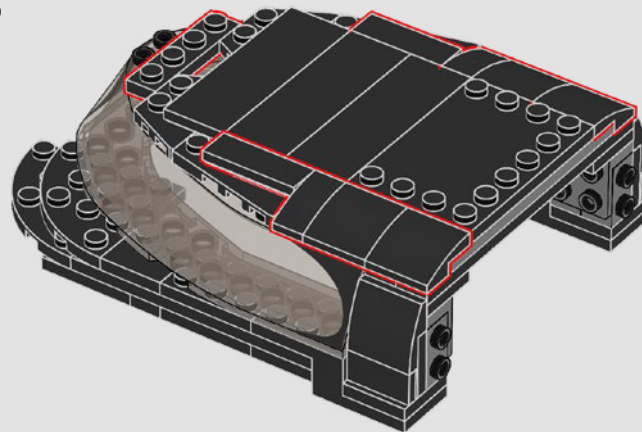

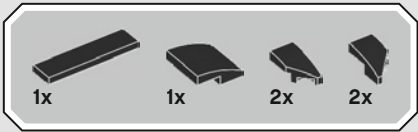

439

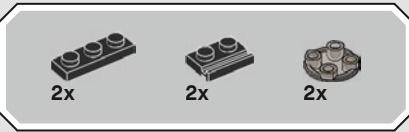
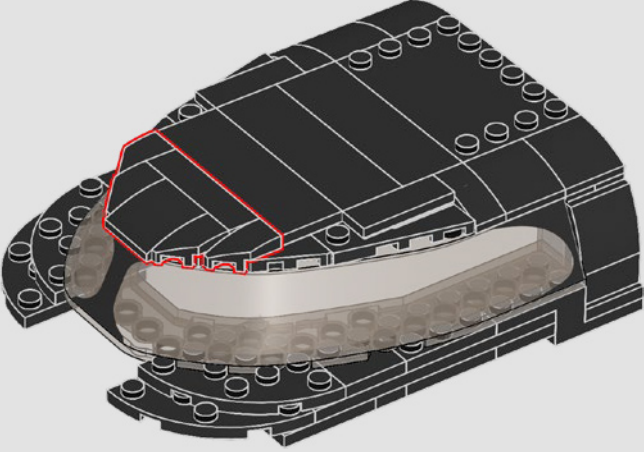

440

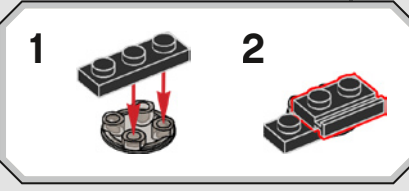
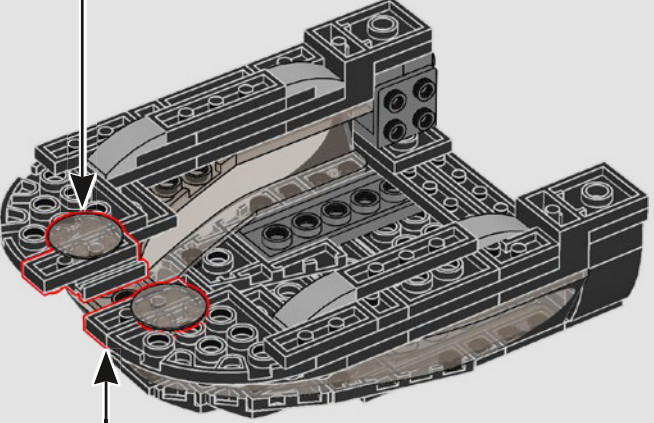
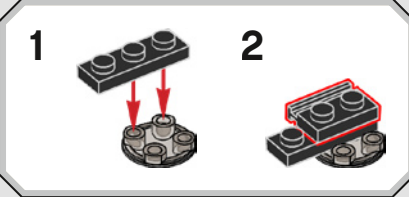



444

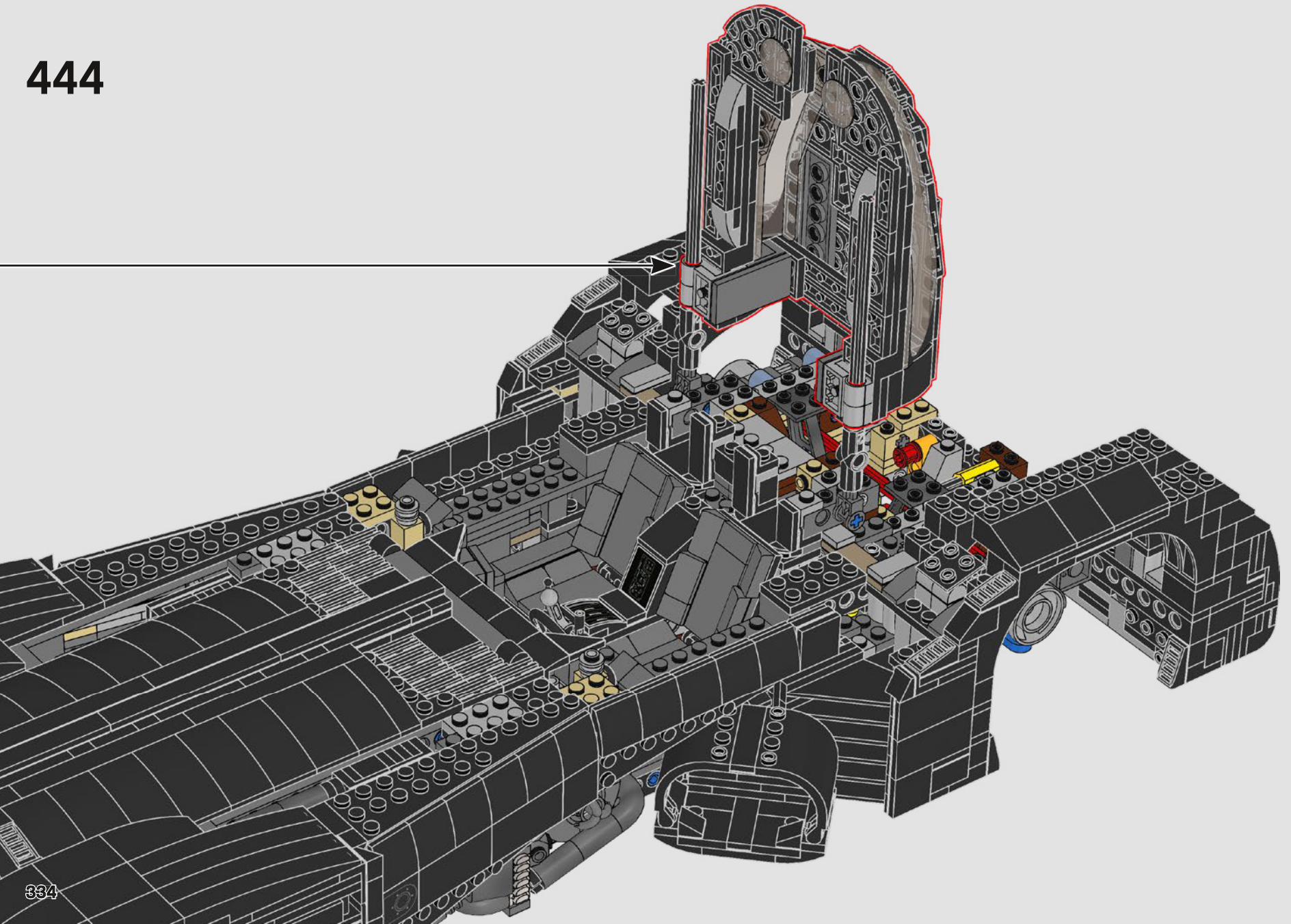

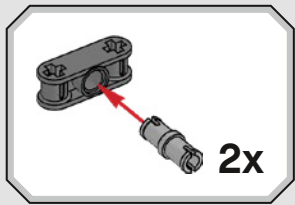

445

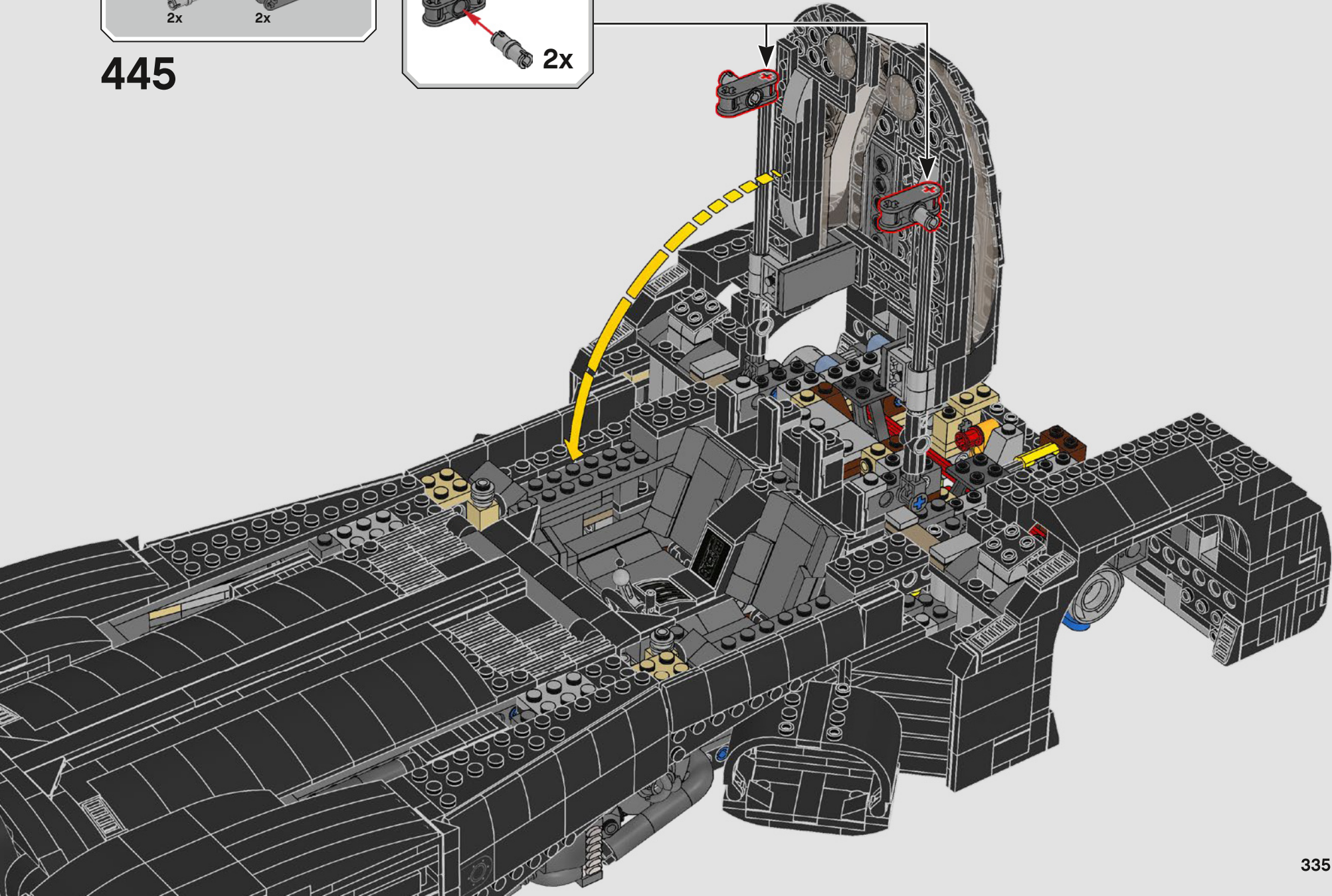

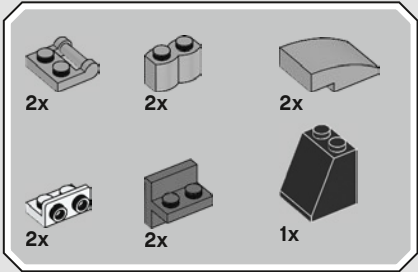
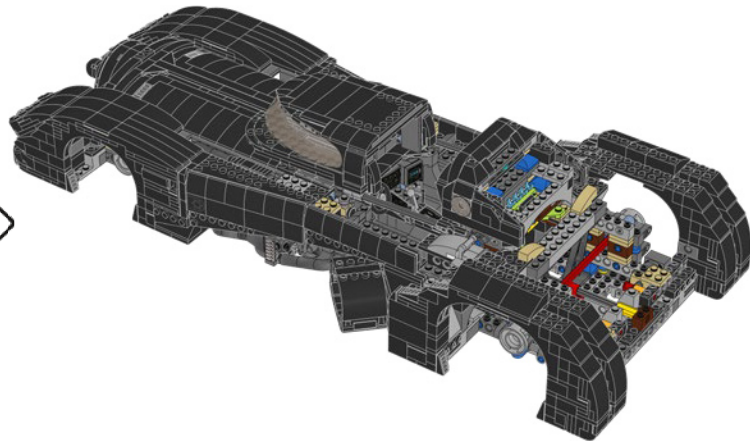

**446**

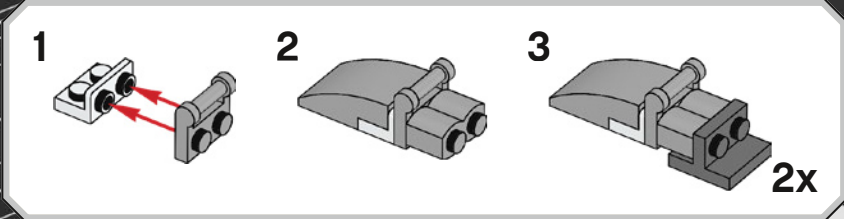



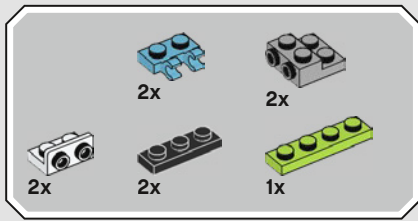

447

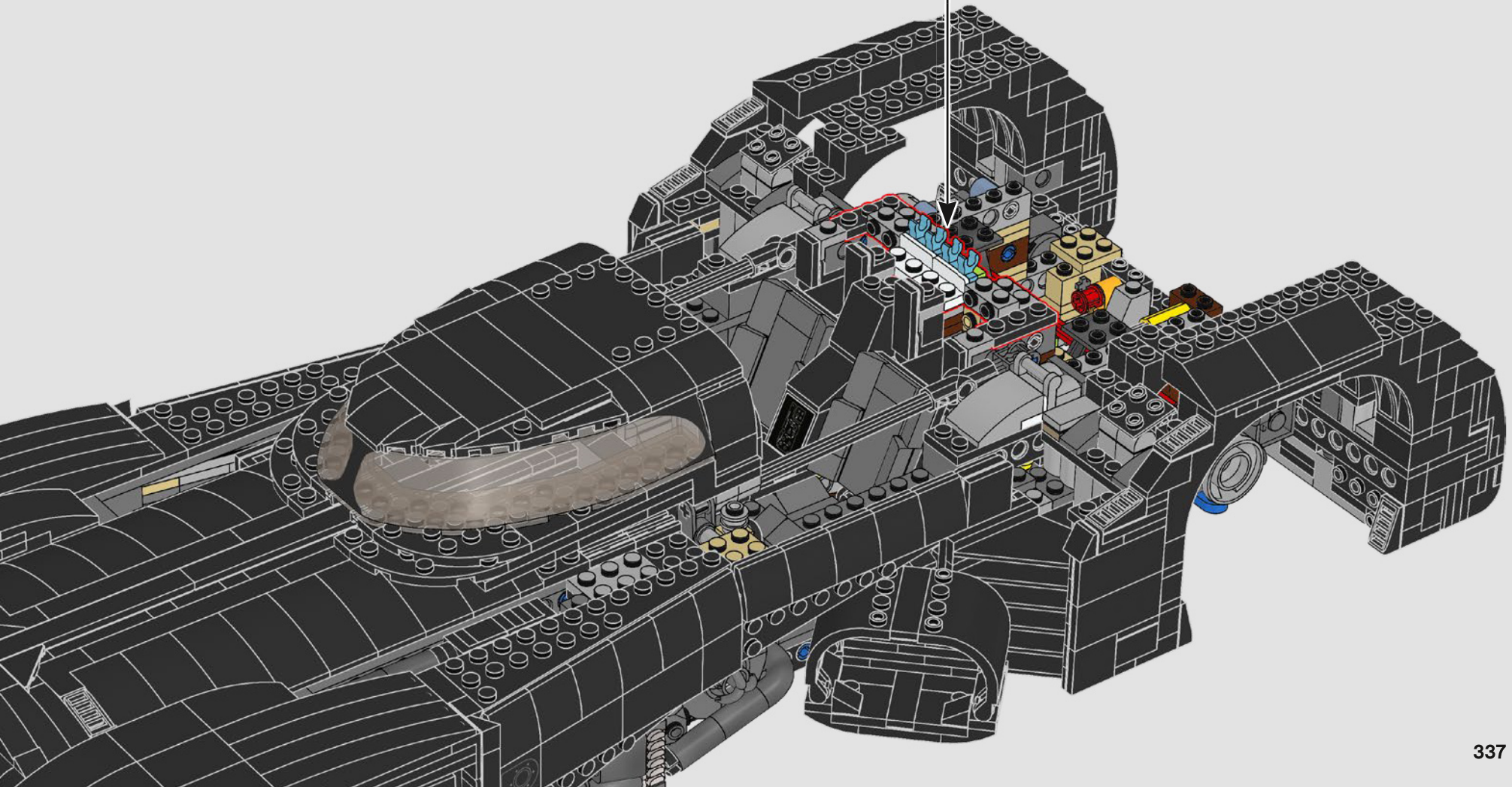
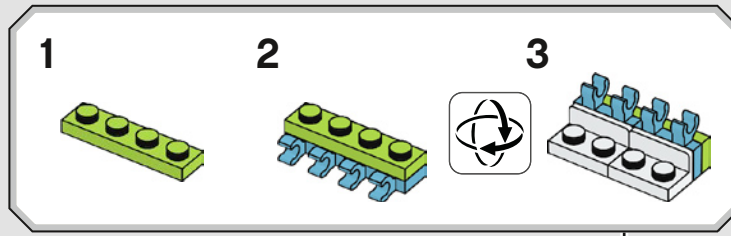

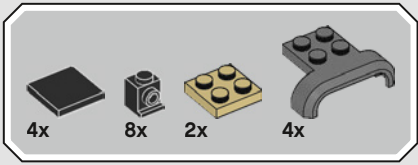

448

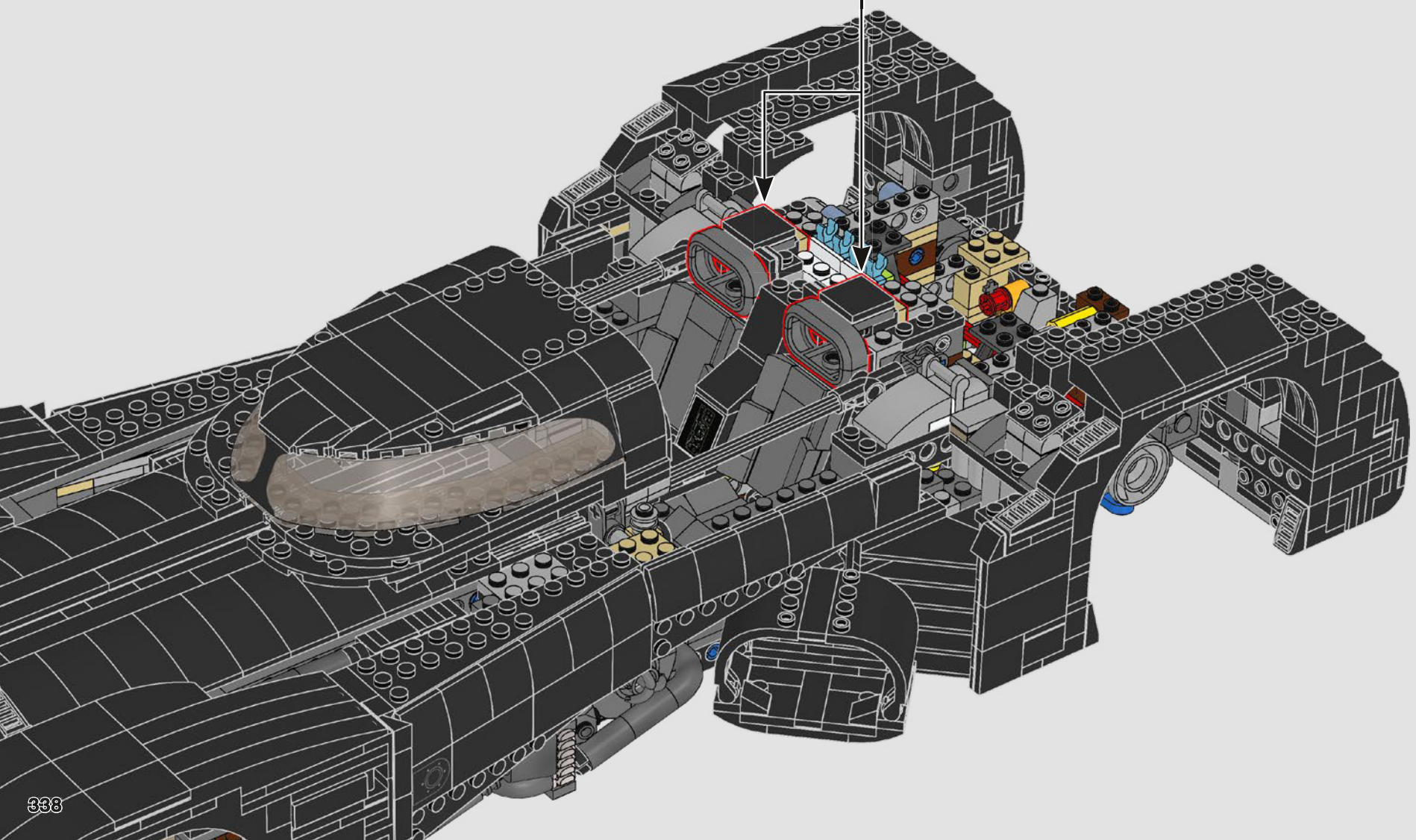
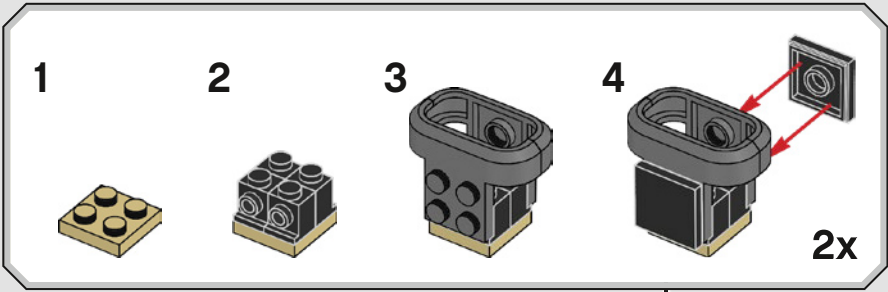

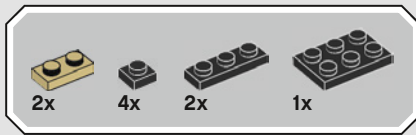

449

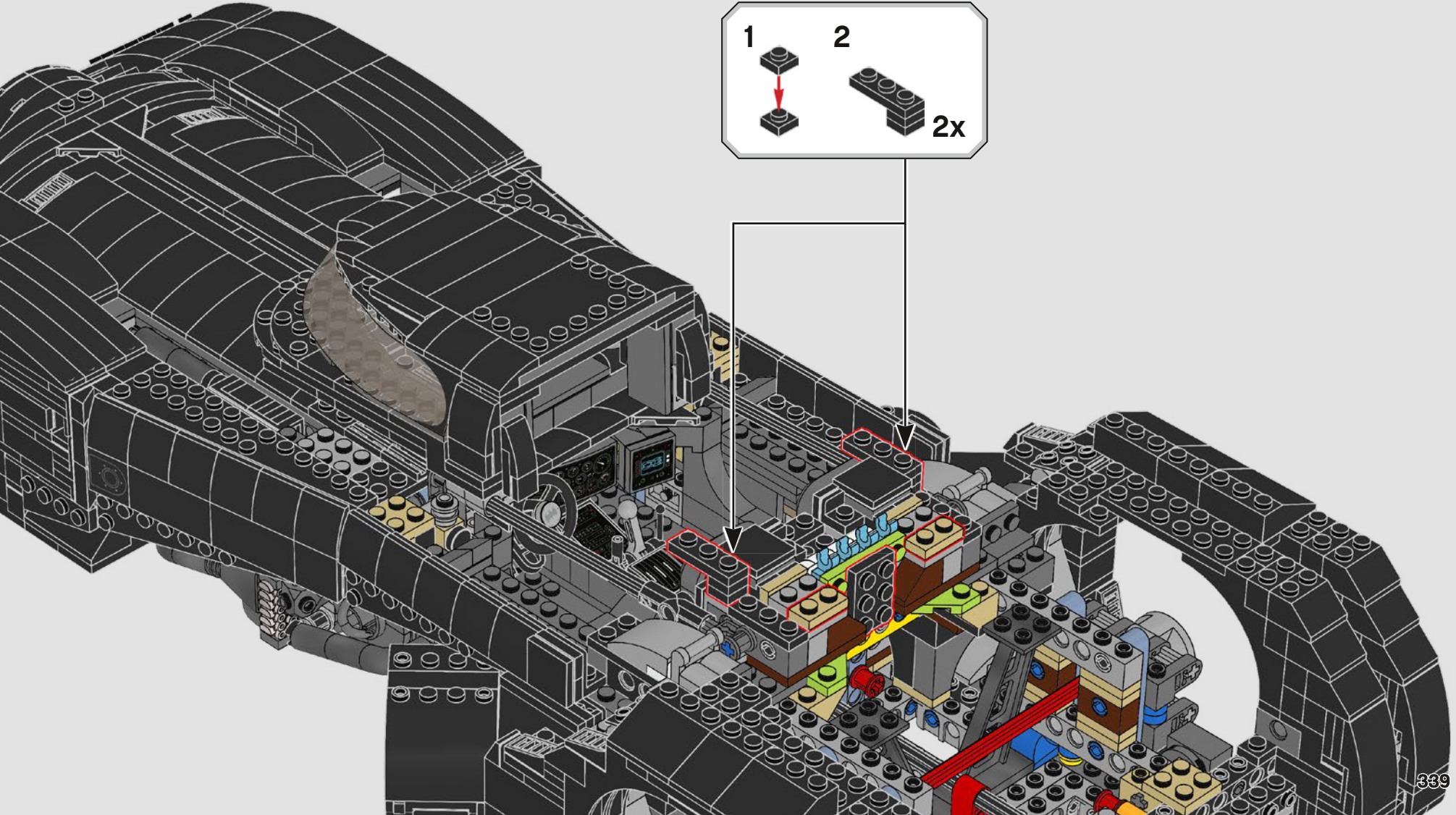
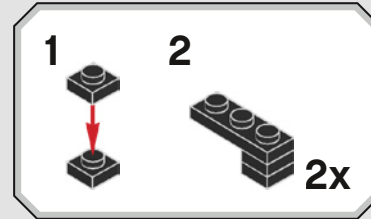

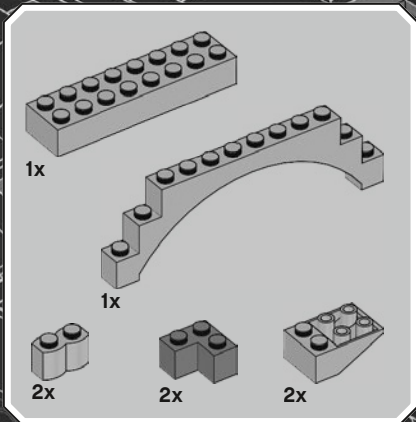

450

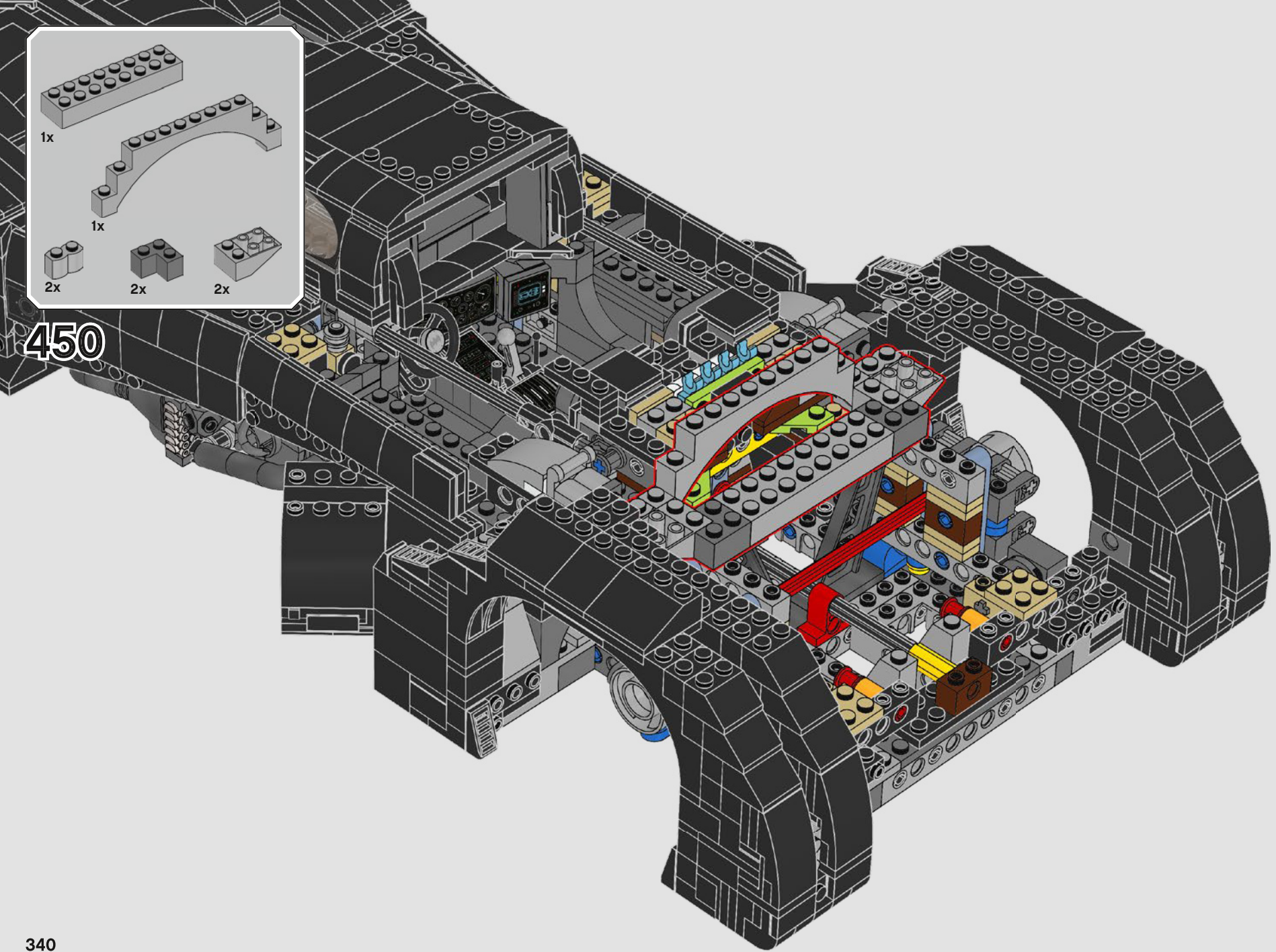

2x  2x  2x 

451

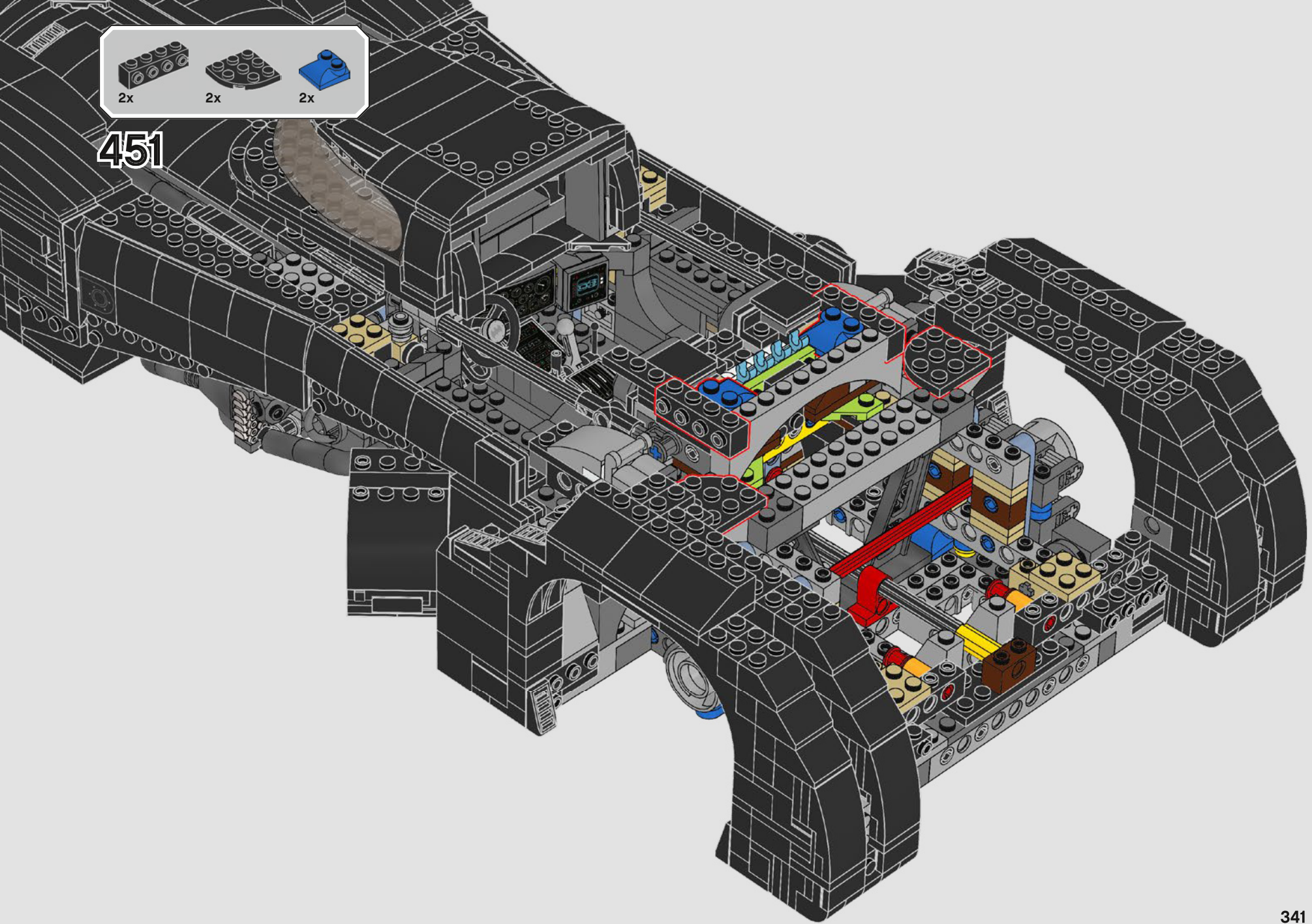

2x 4x 2x

452

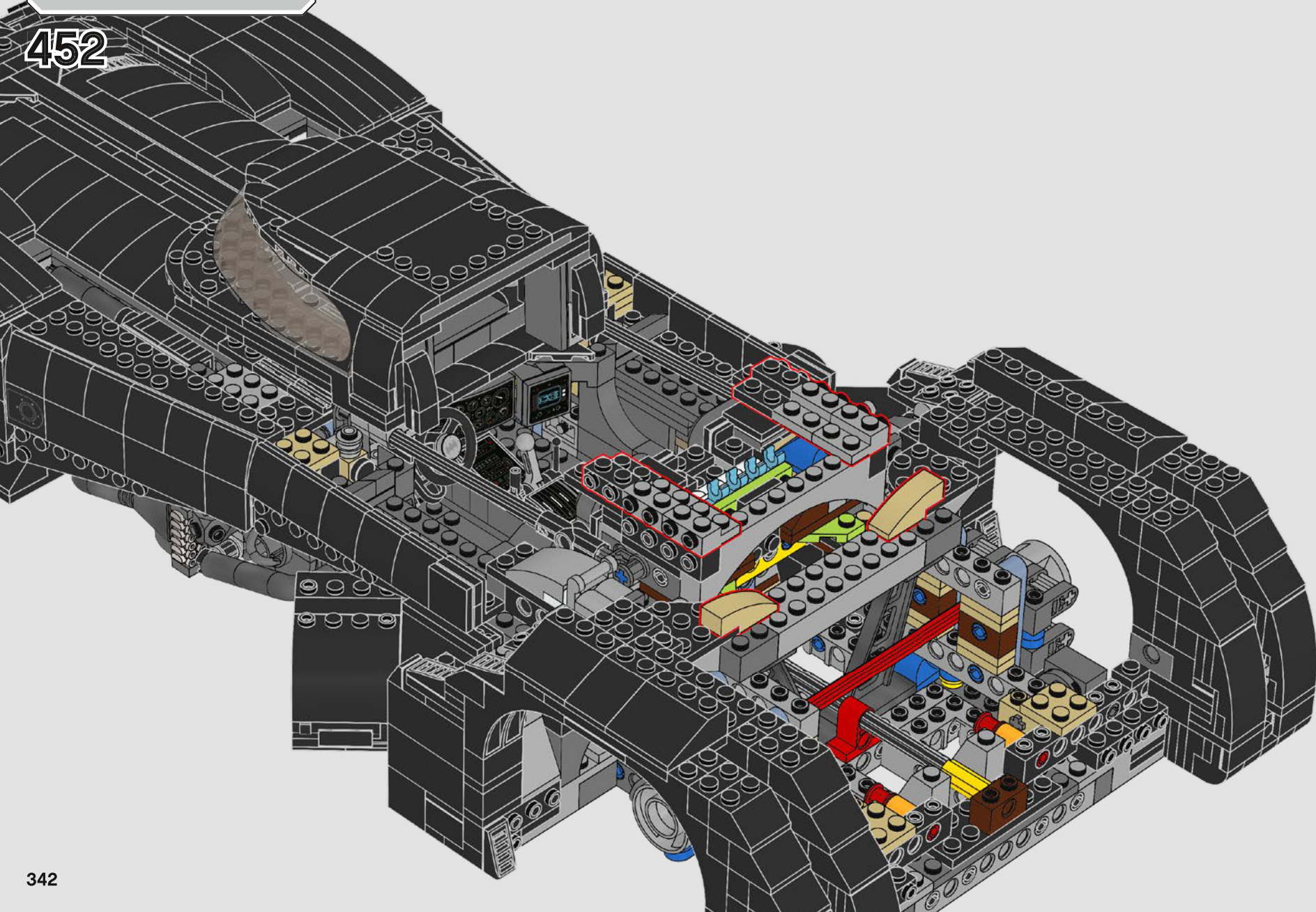

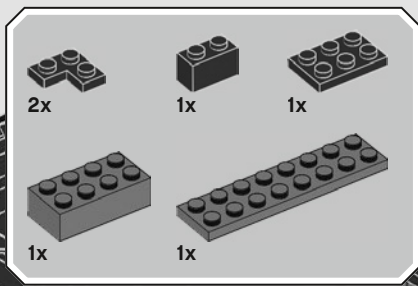

453

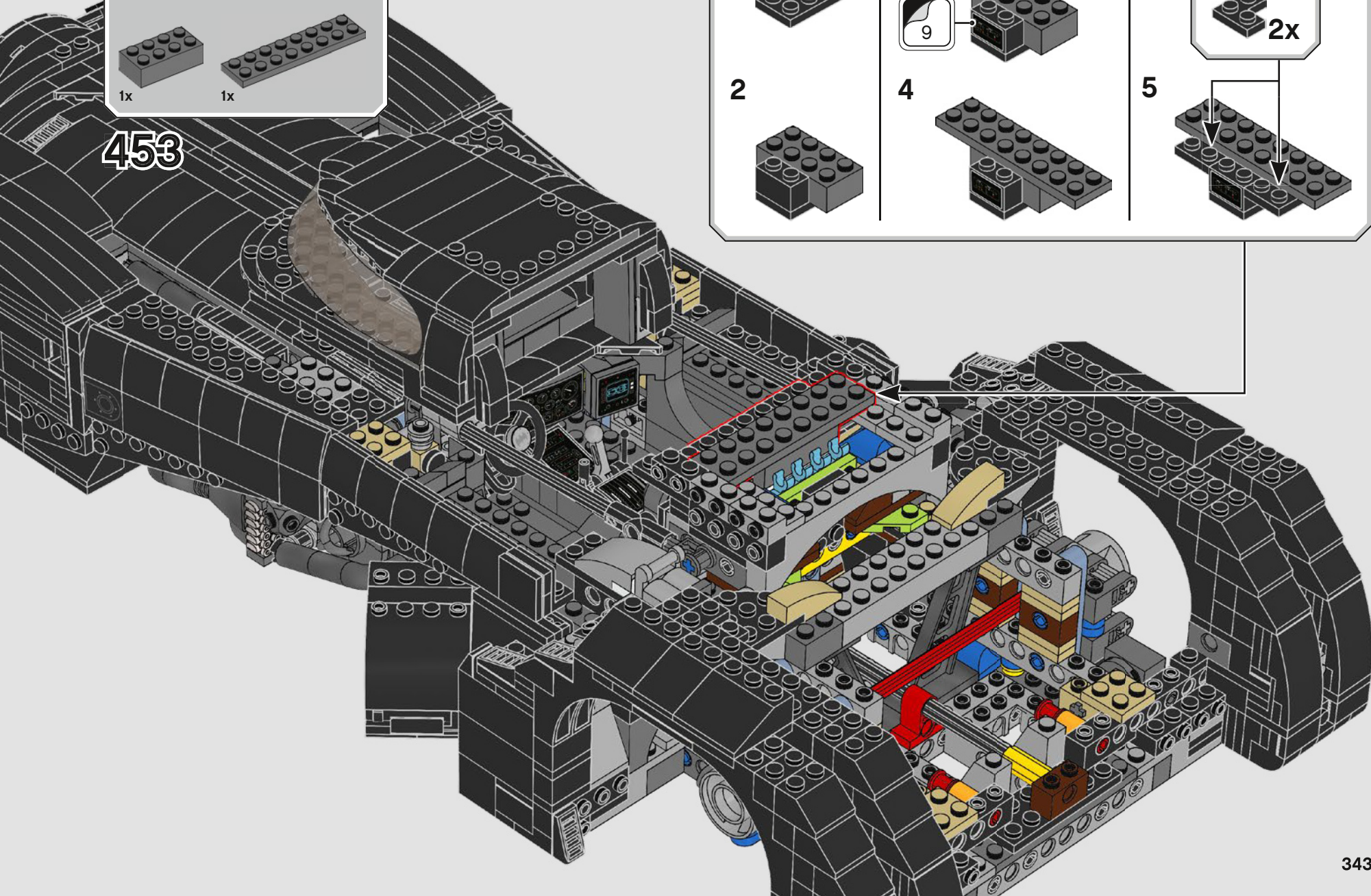
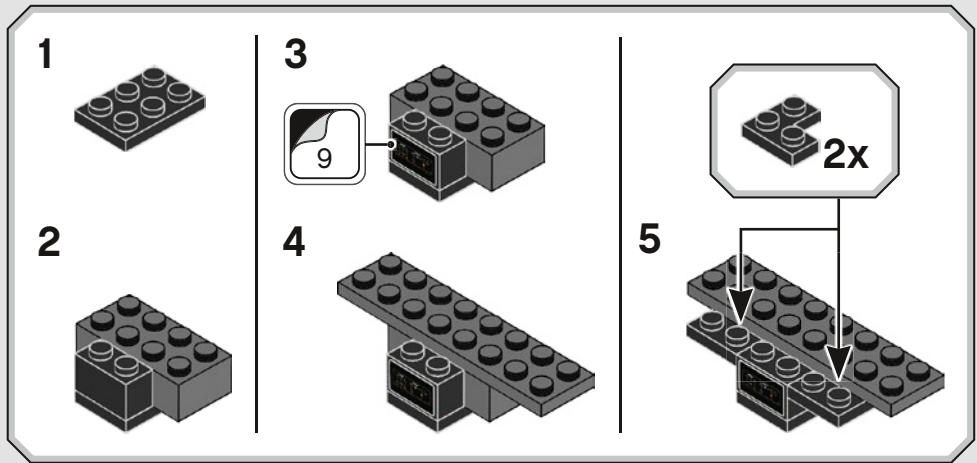



4x



2x

454

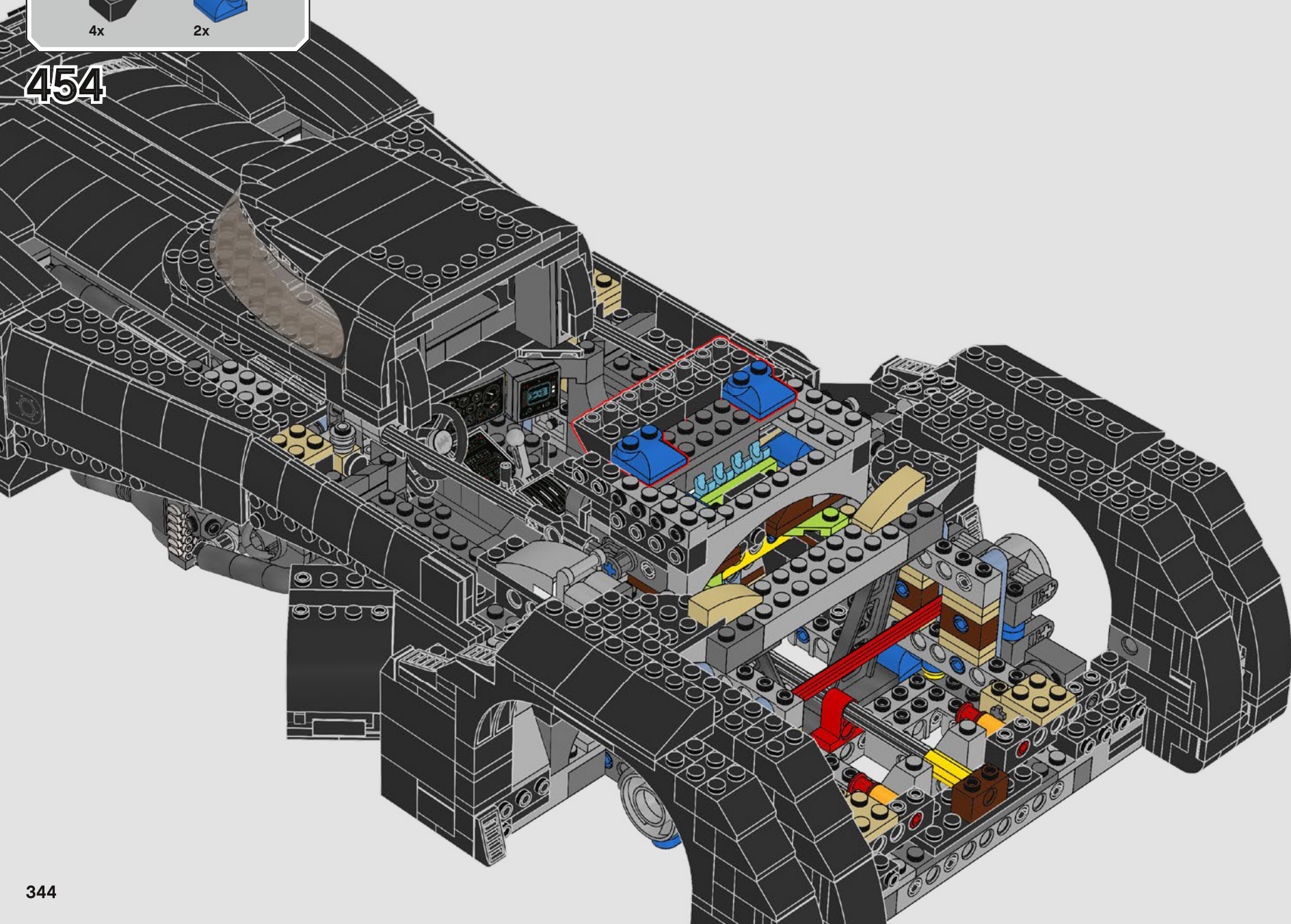



2x 2x 2x

455

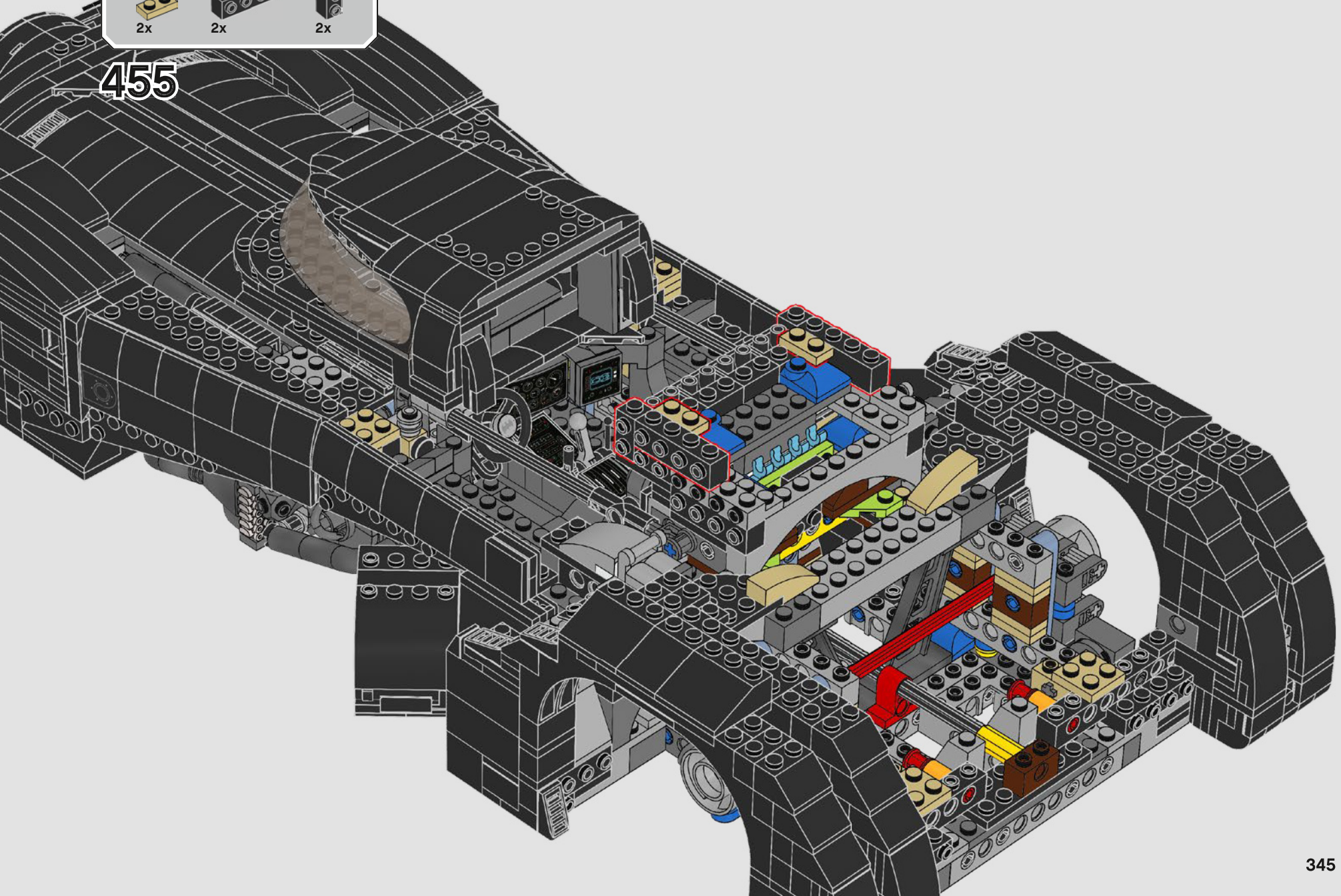

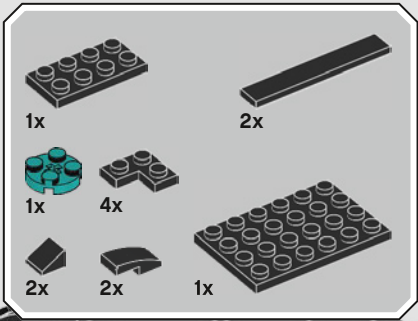

456

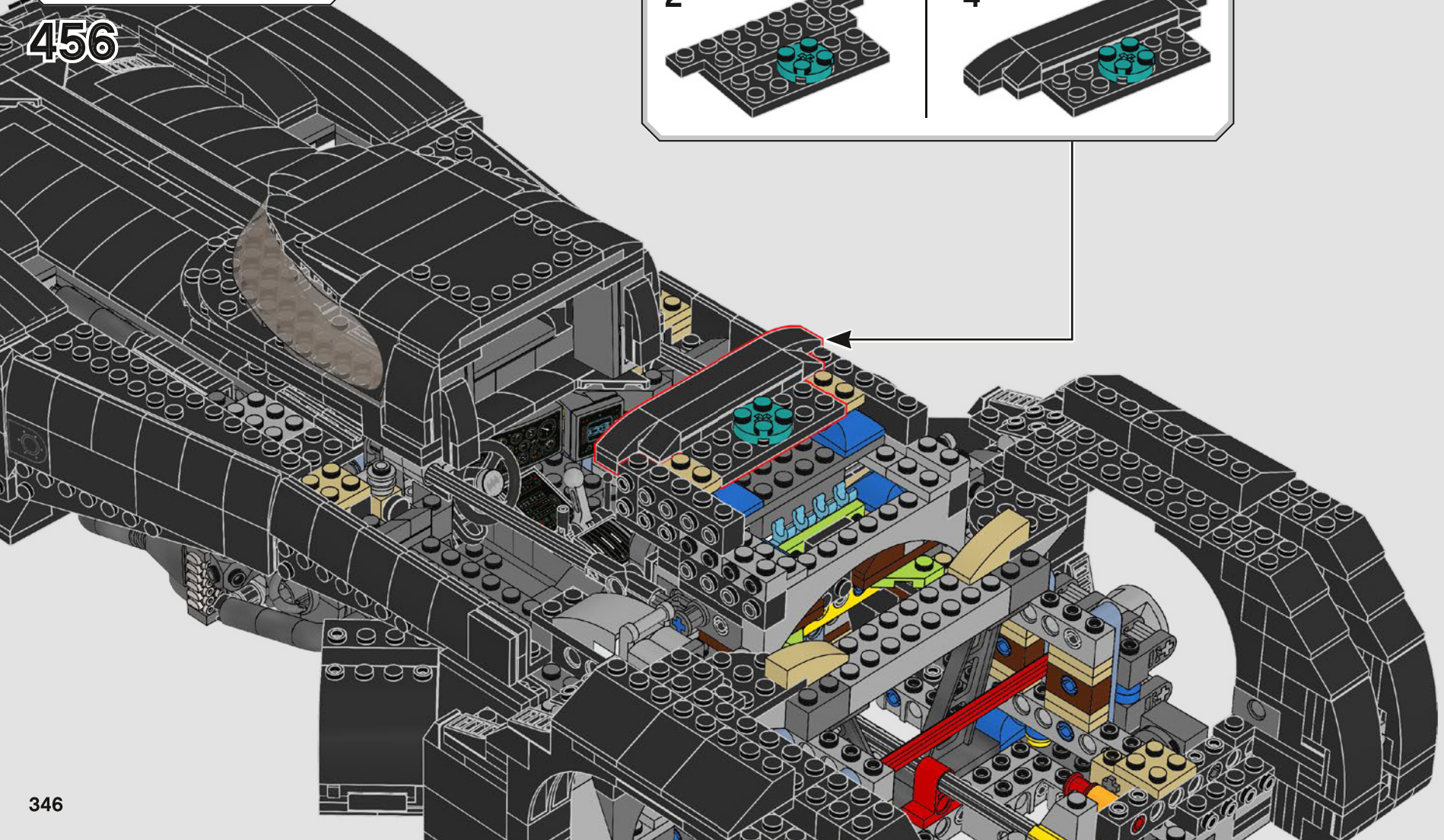
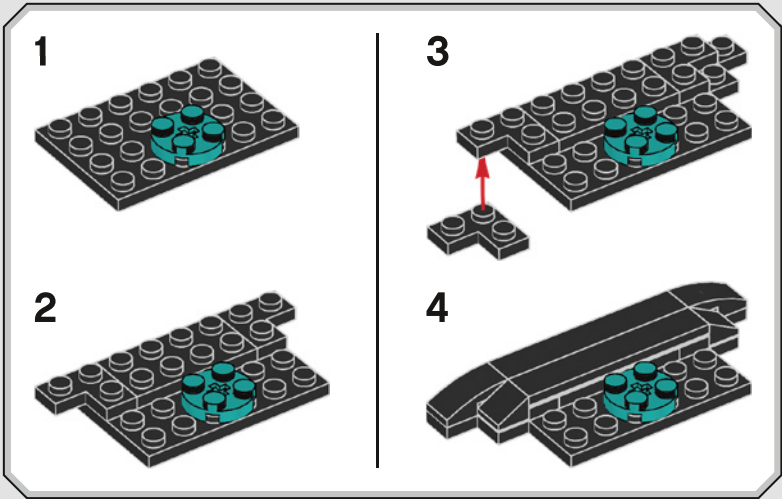

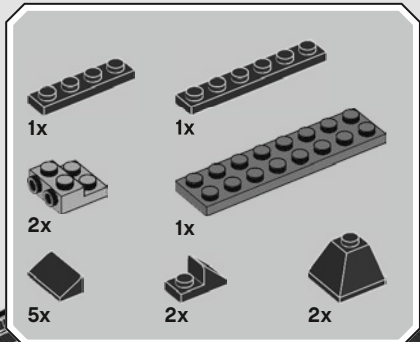

457

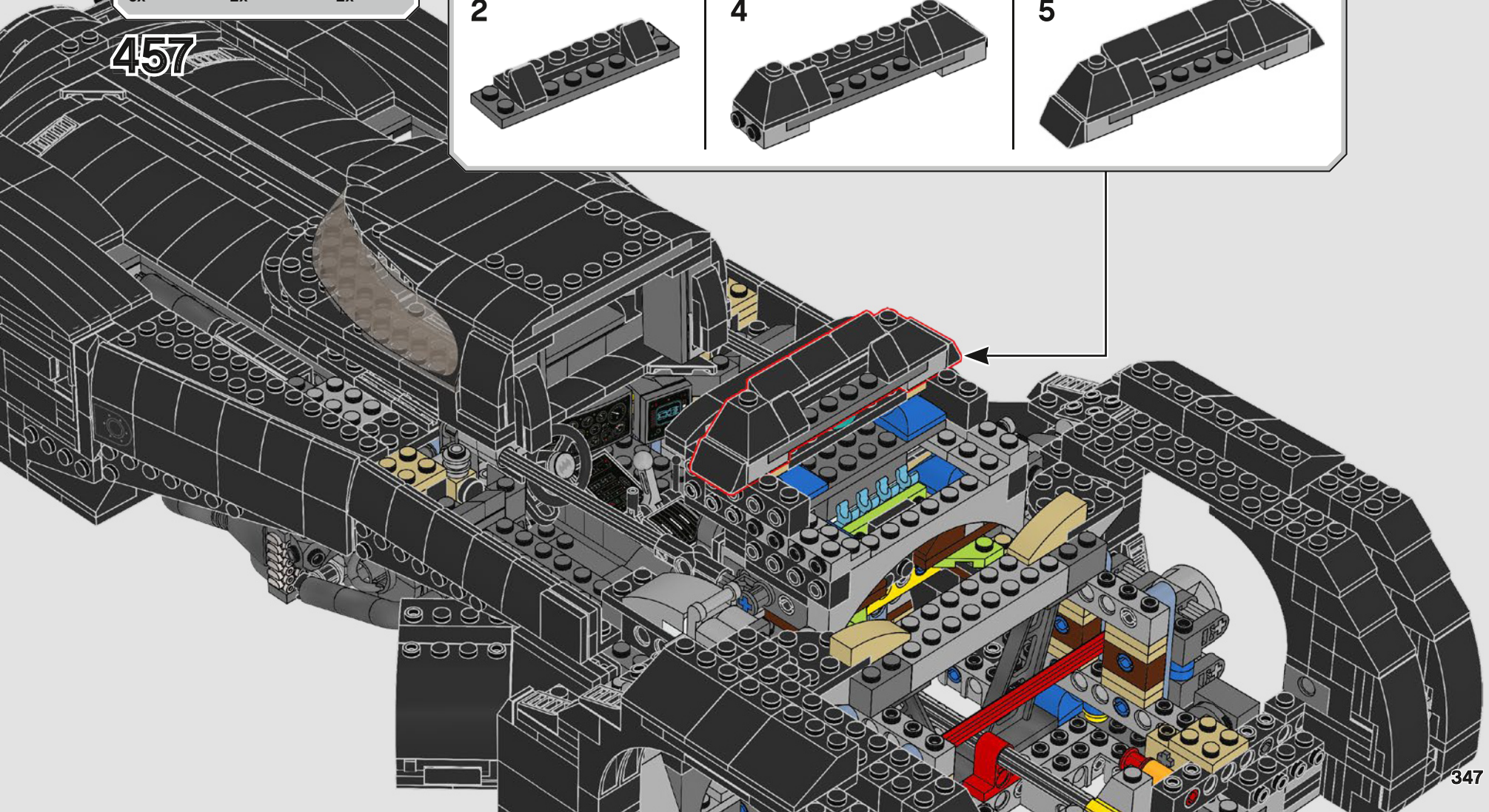
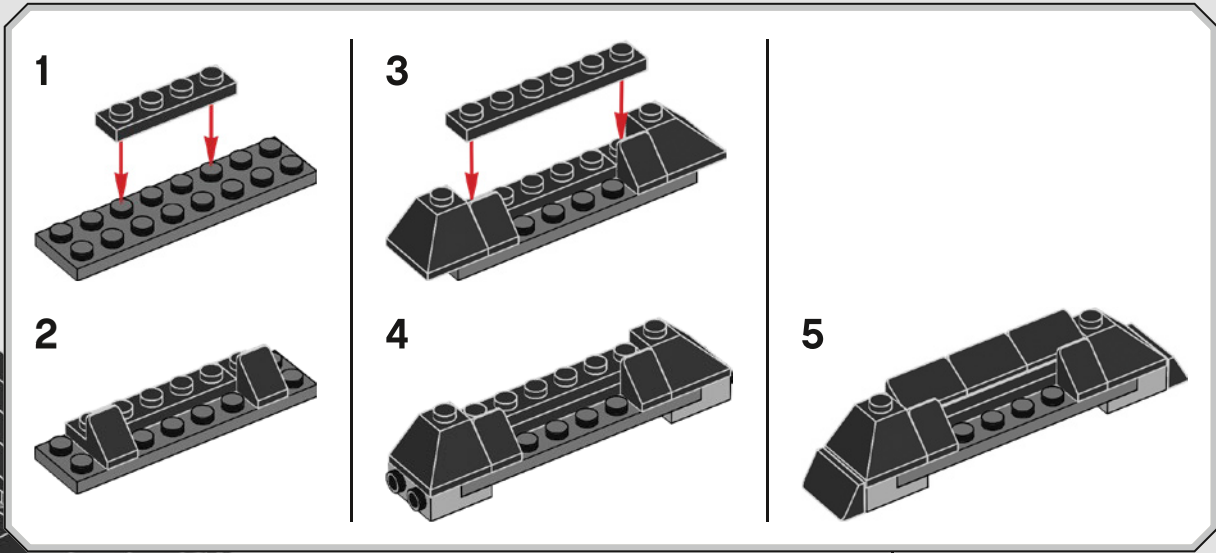

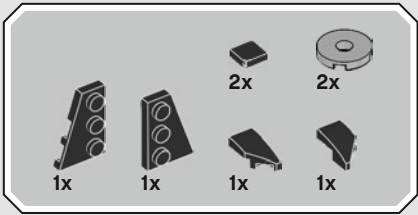

458

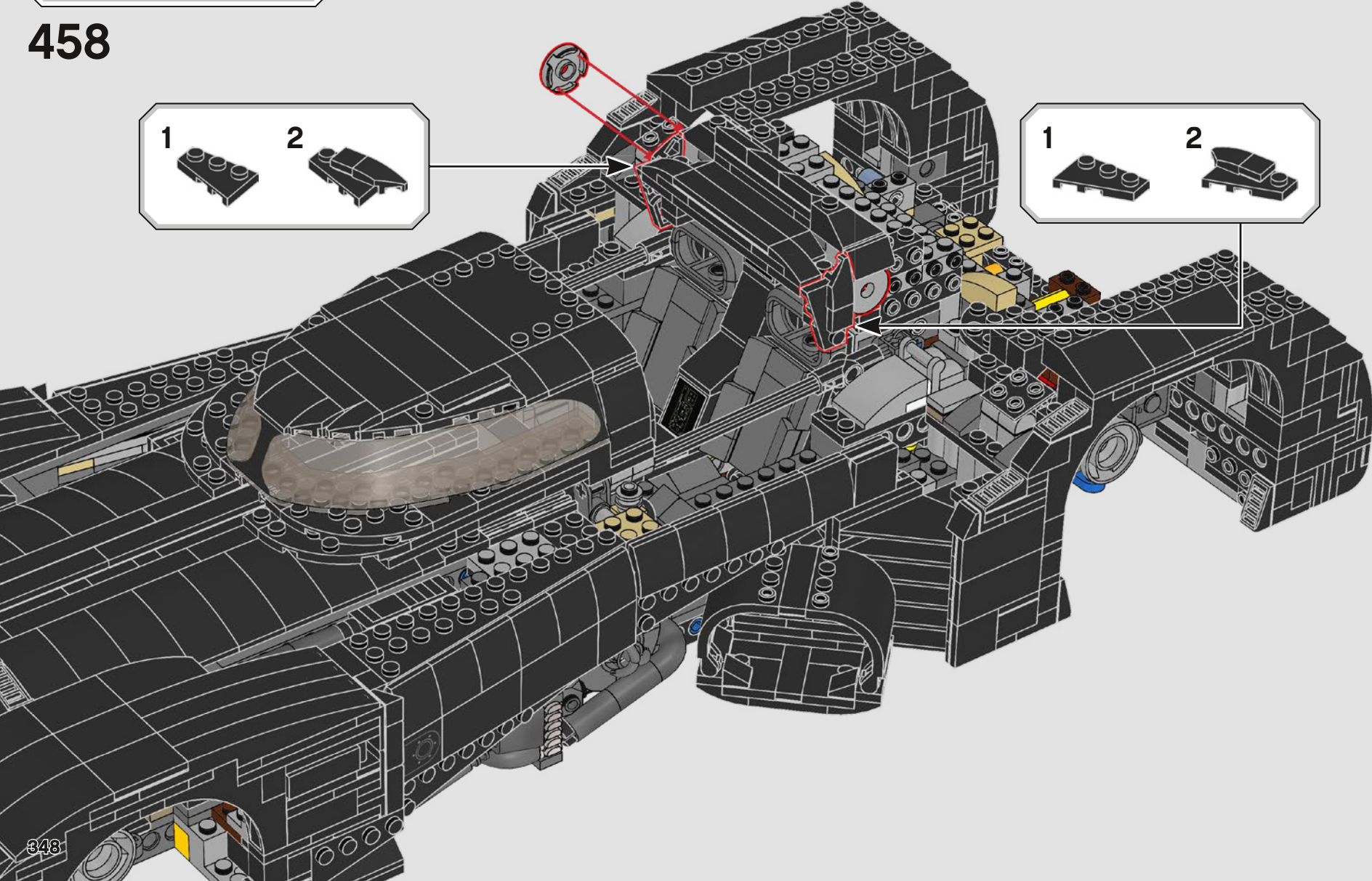
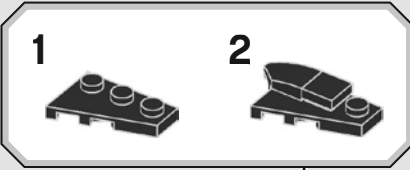
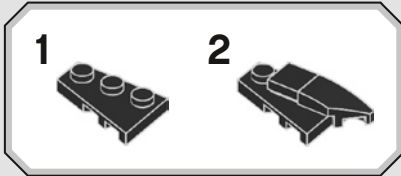

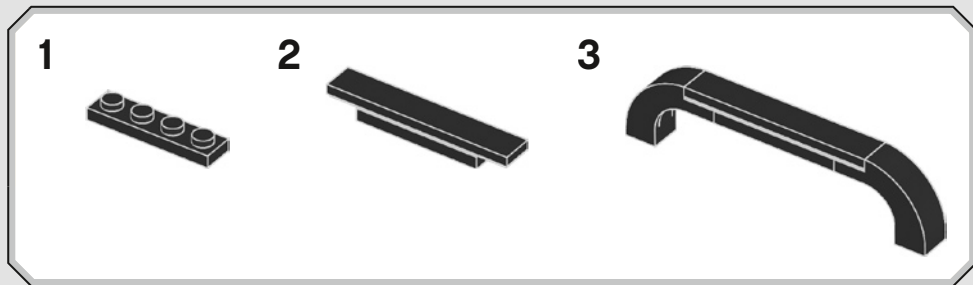
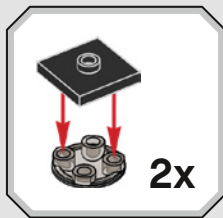
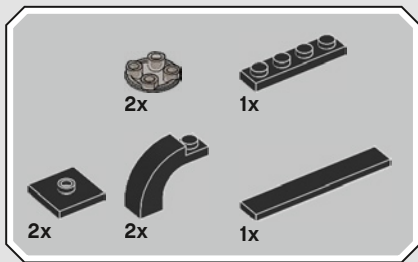

459

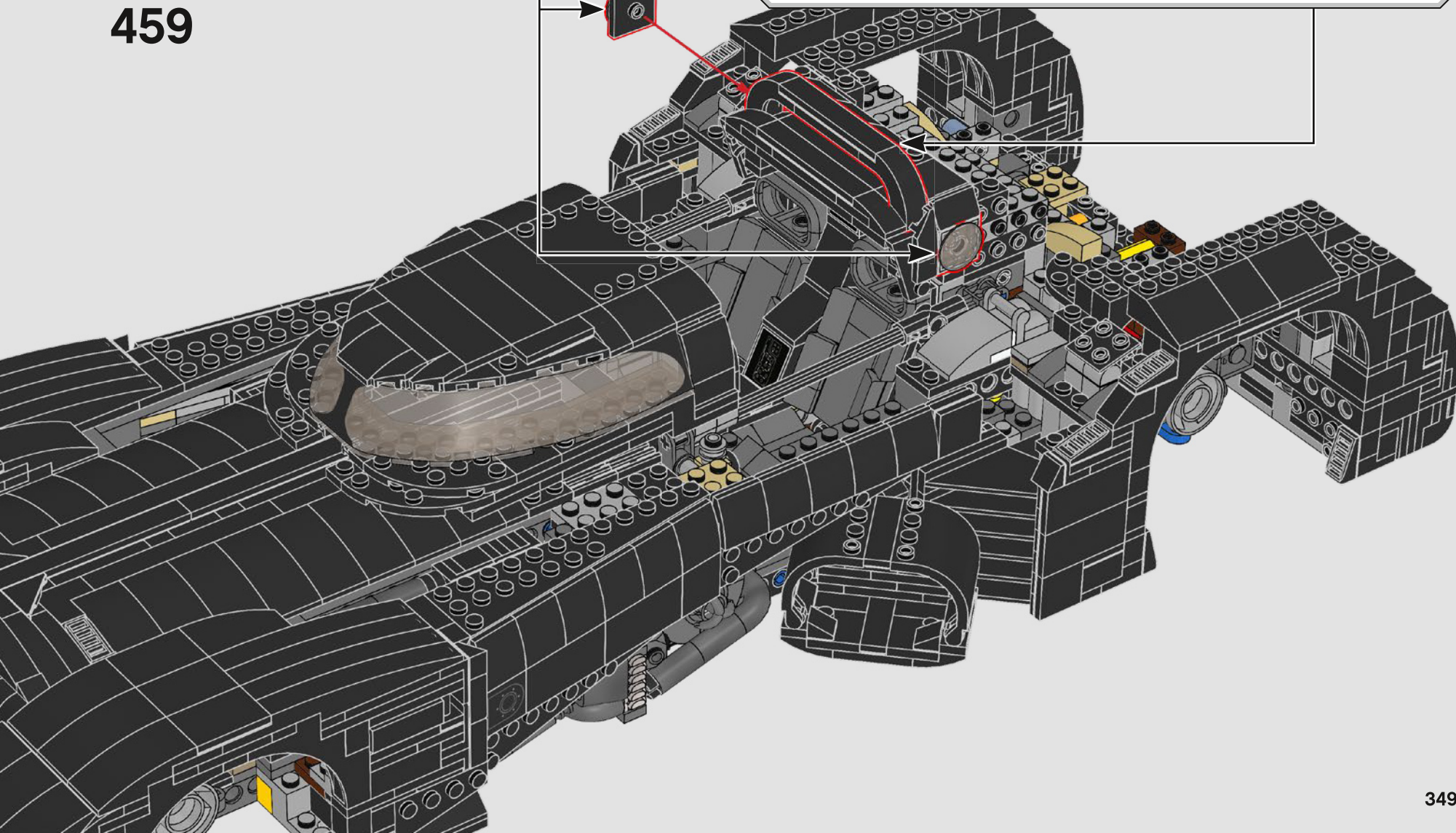

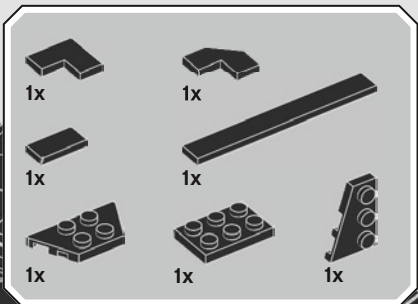

460

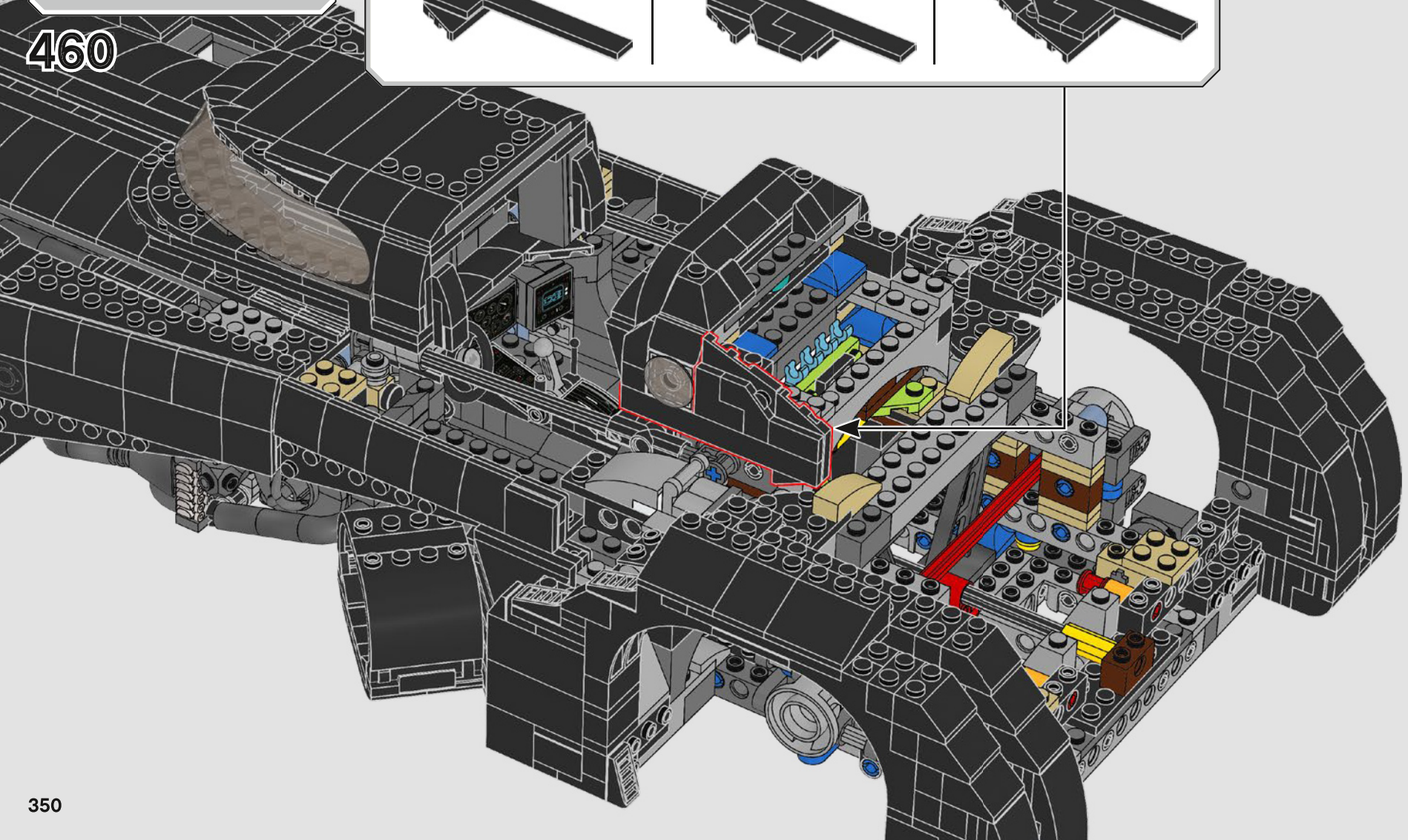
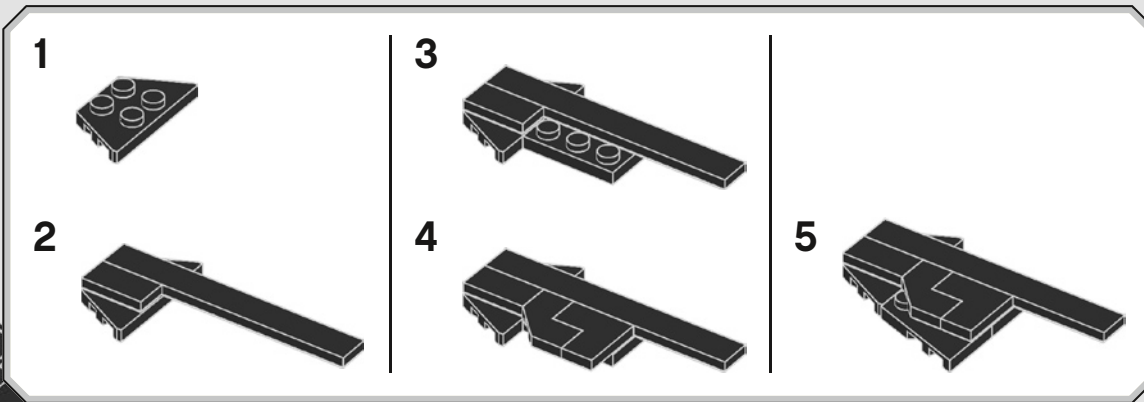

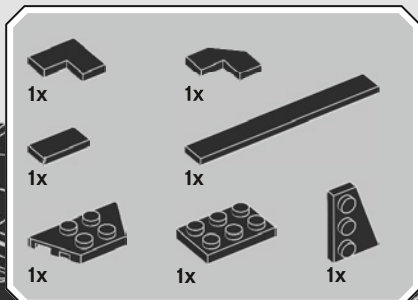

461

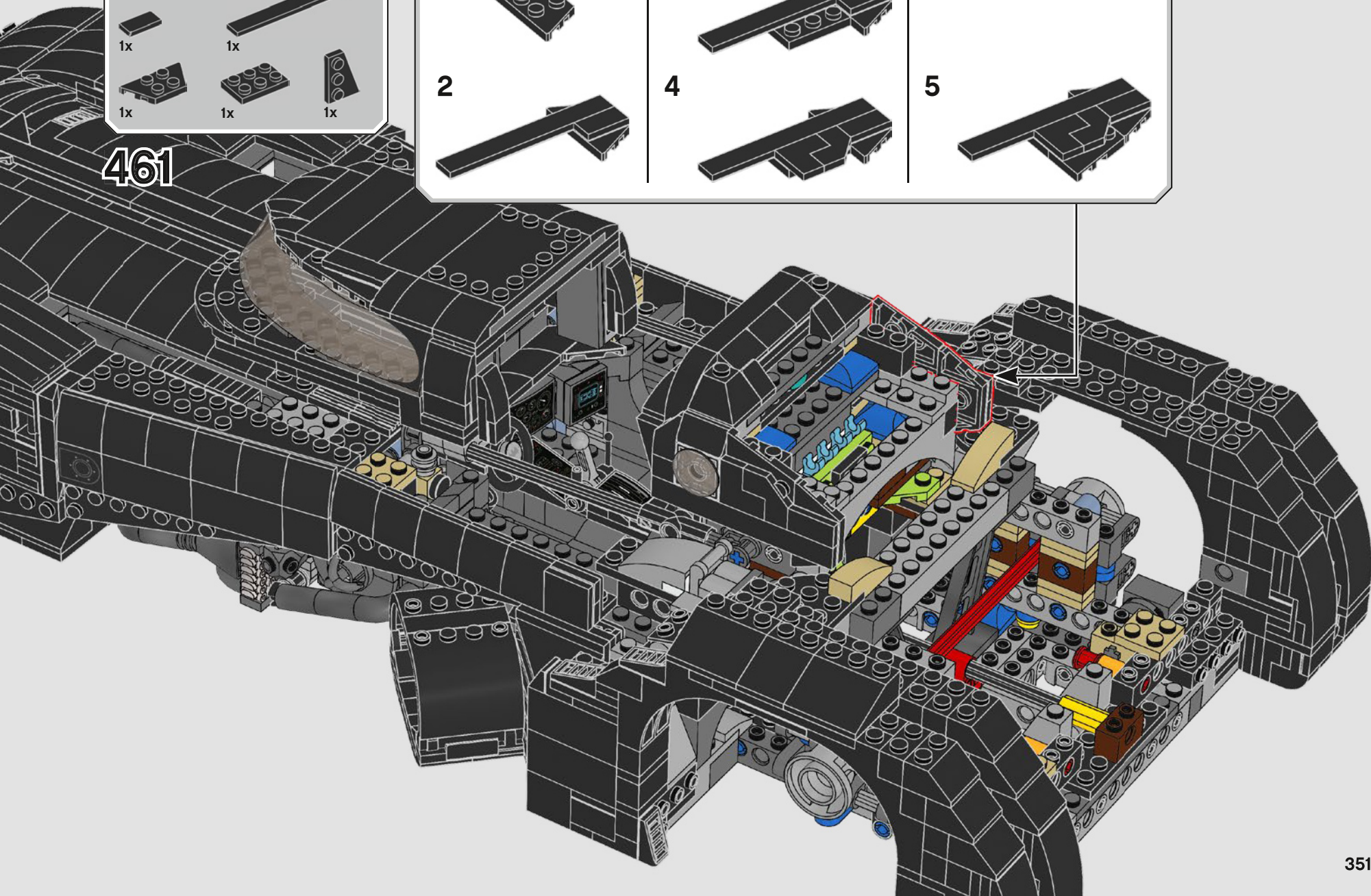
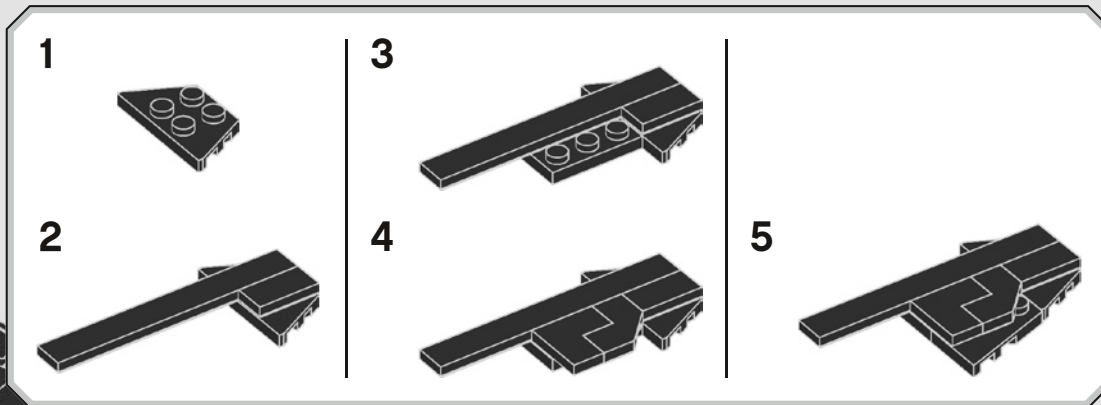

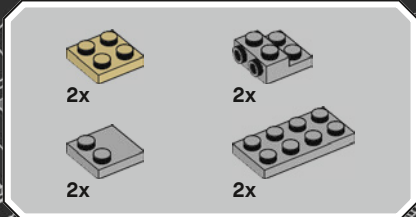
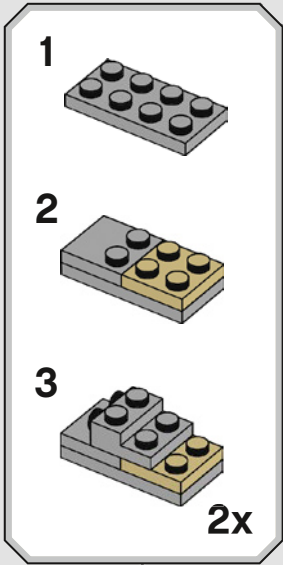
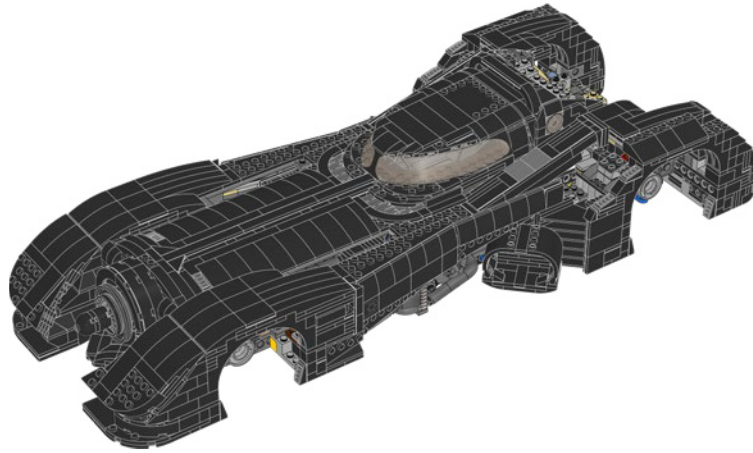

462

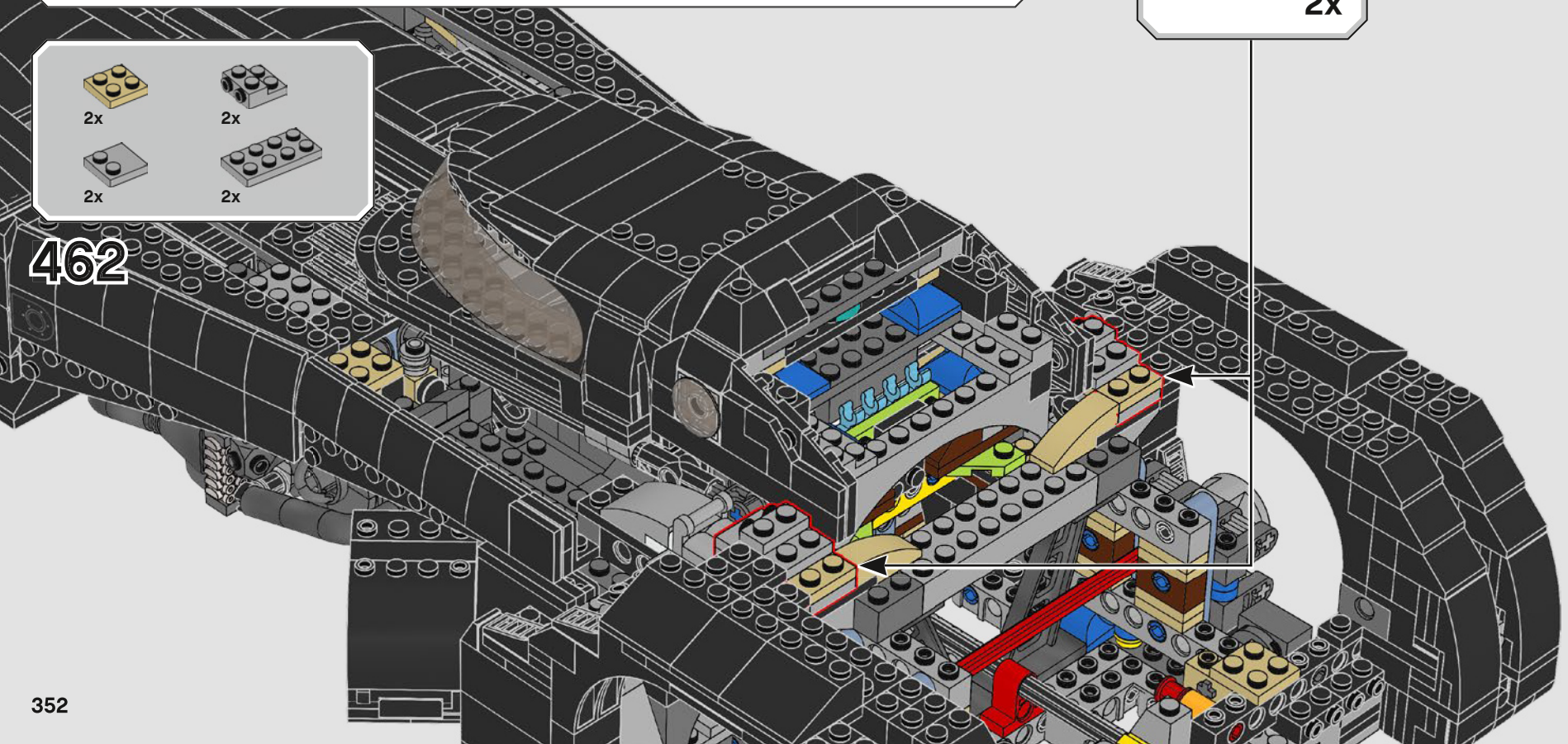



2x	2x
2x	2x

463

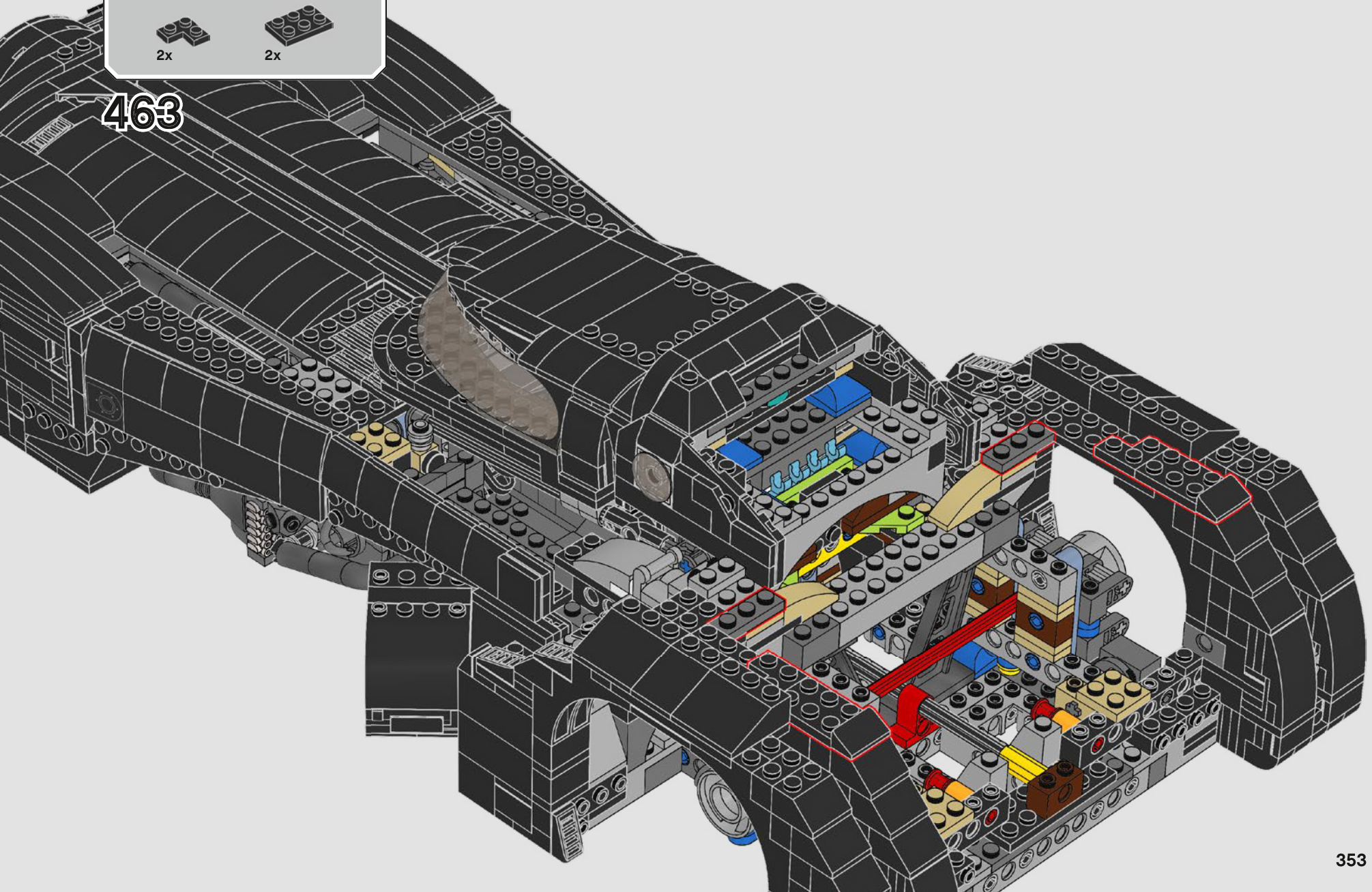

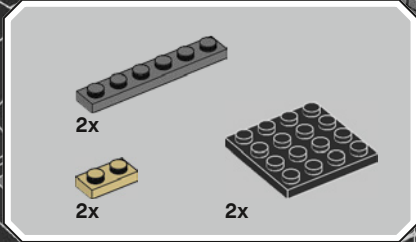

464

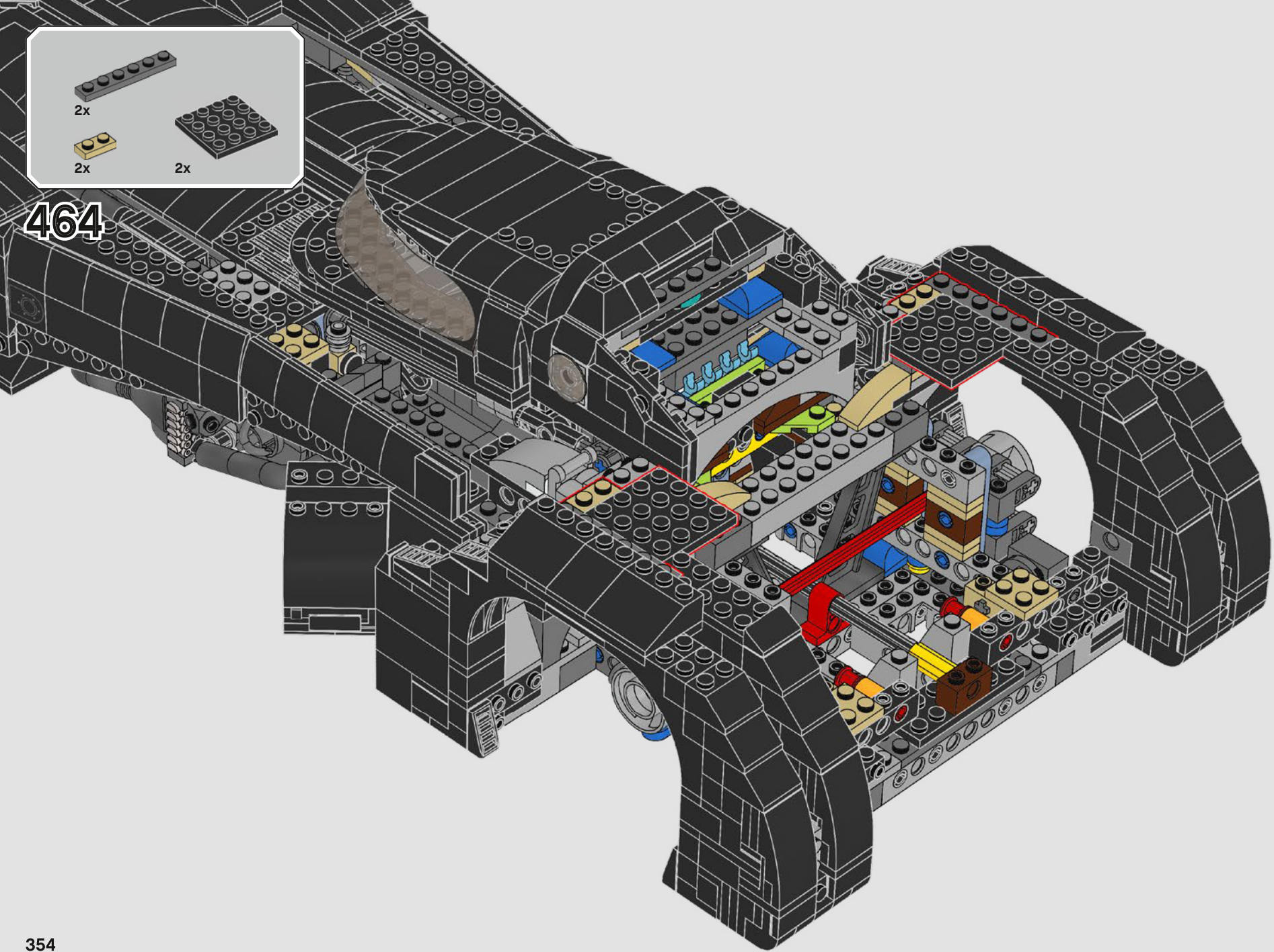



4x



2x

465

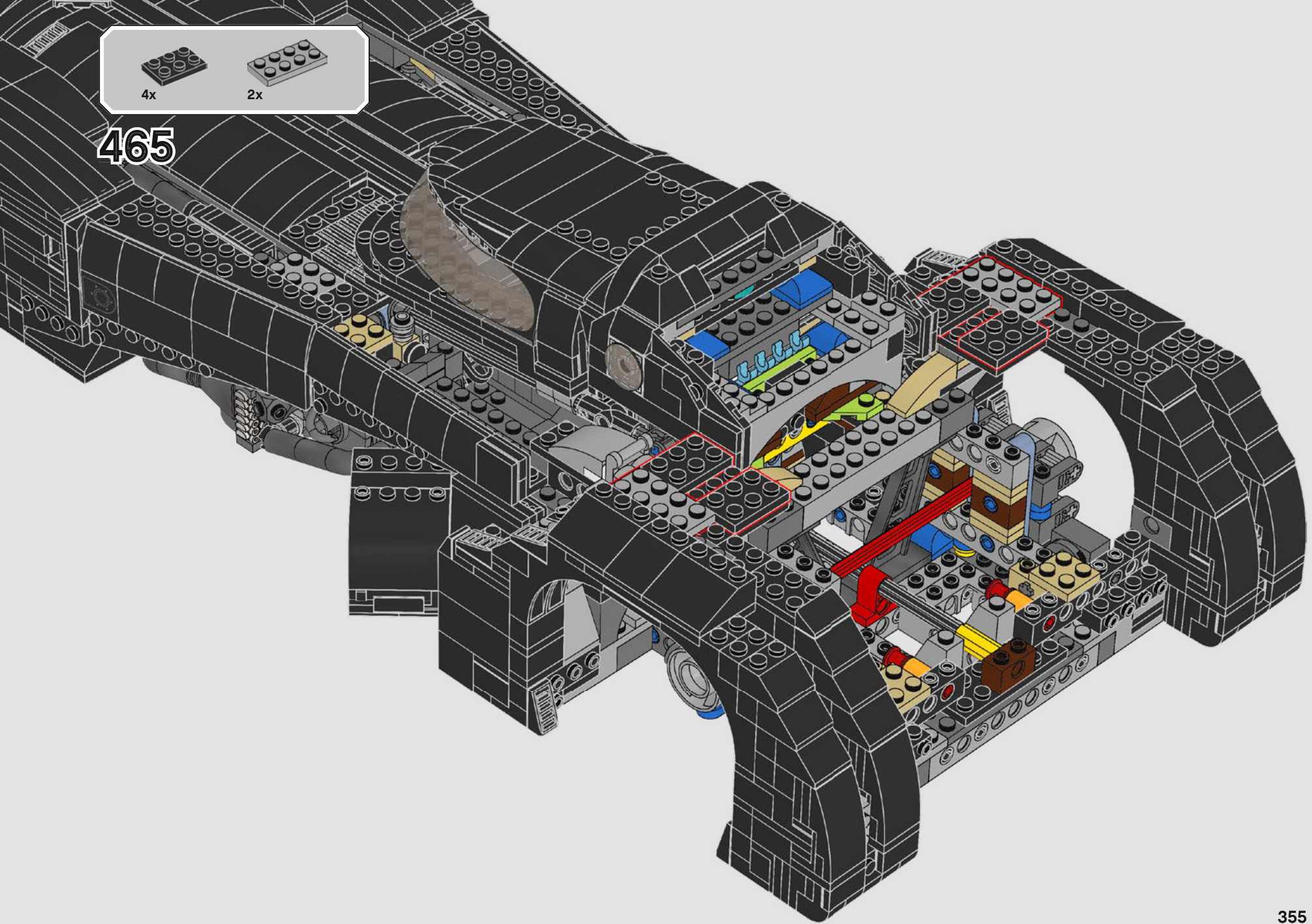

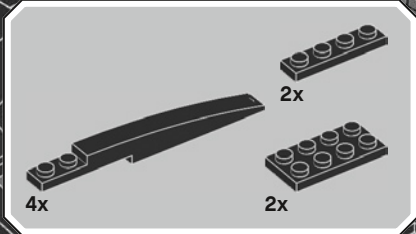

466

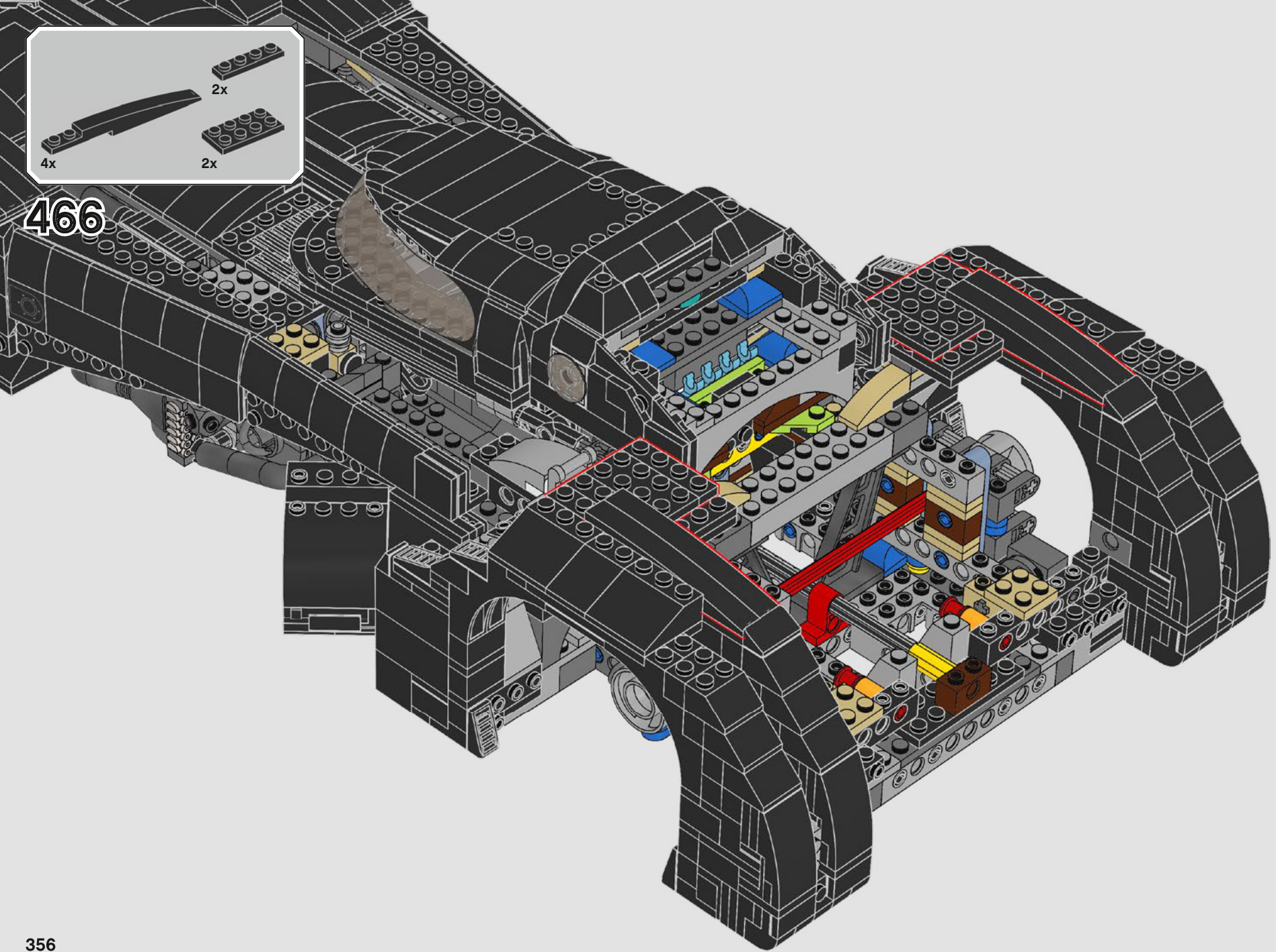

2x 2x 2x 4x



467

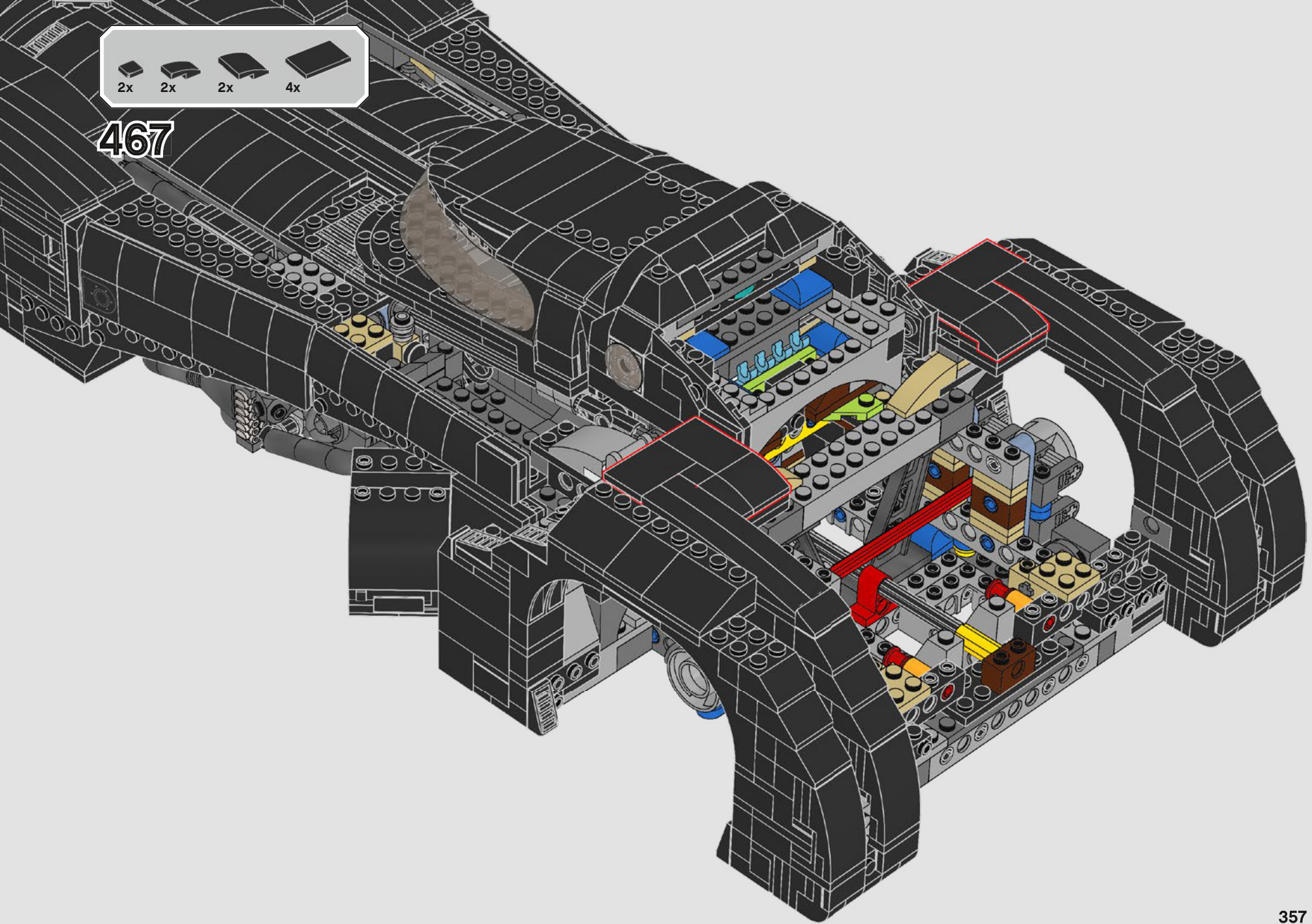



468

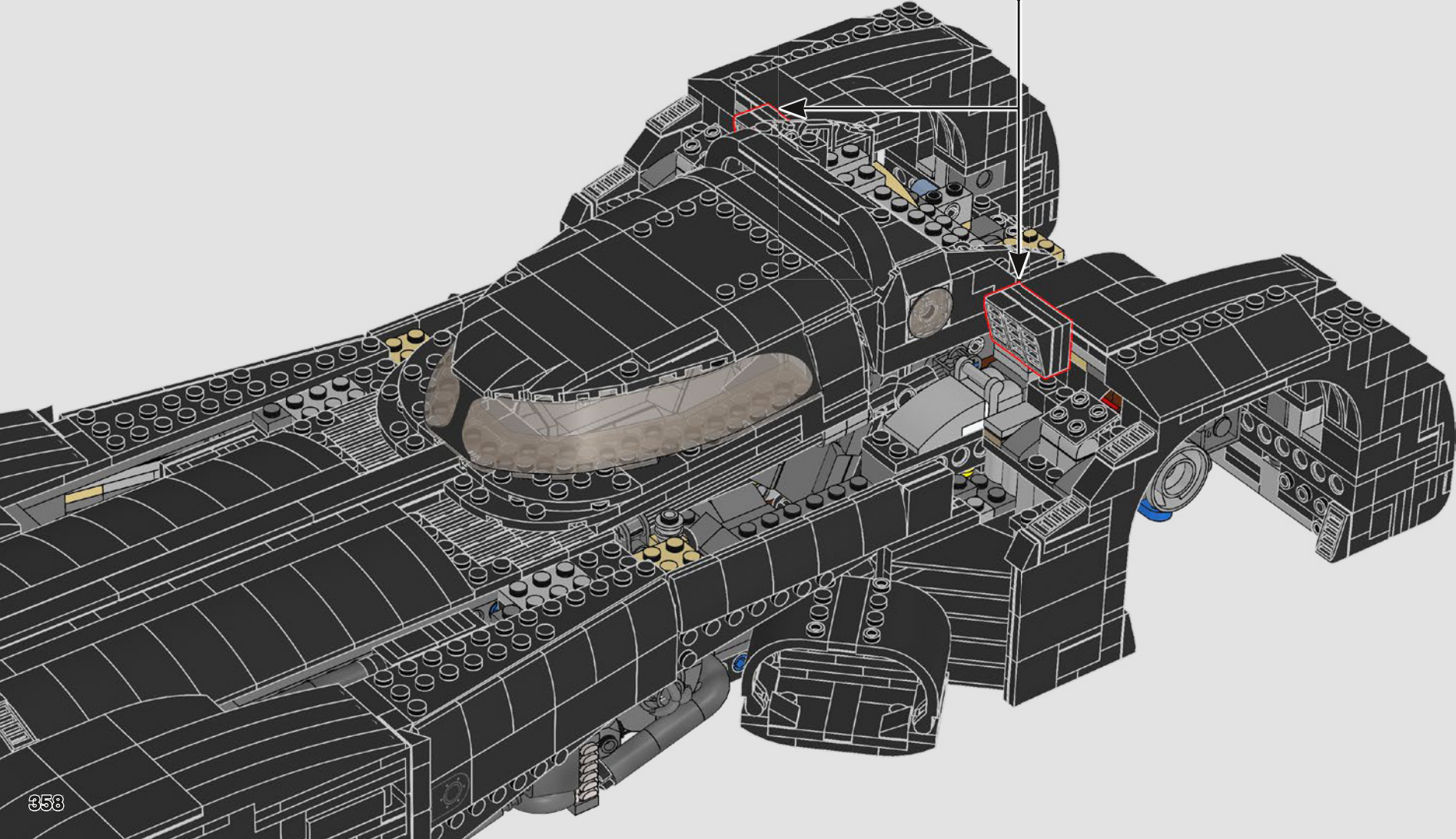
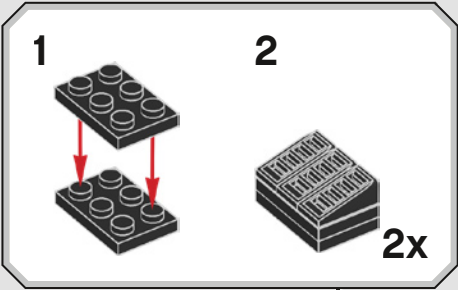

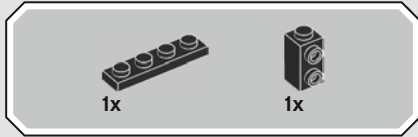
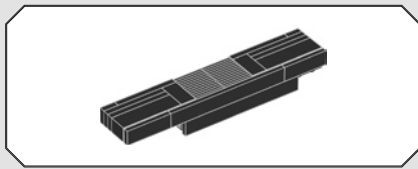

469

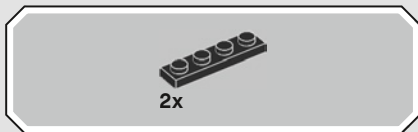
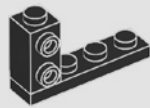

470

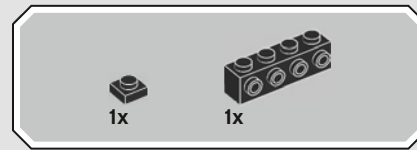
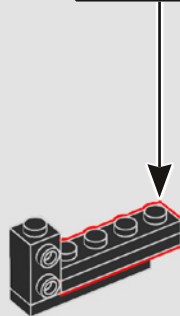
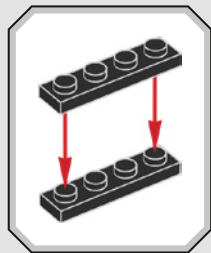

471

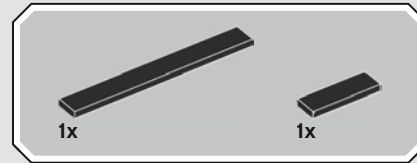
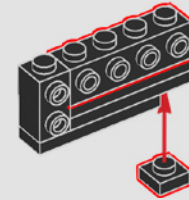

472

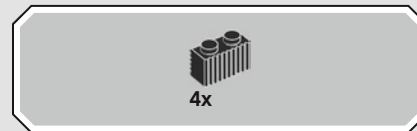
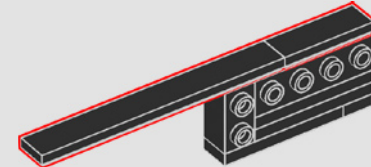

473

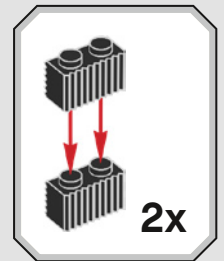
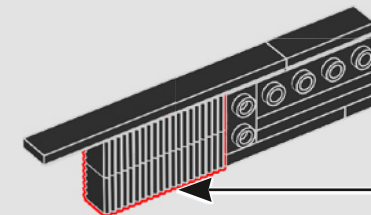

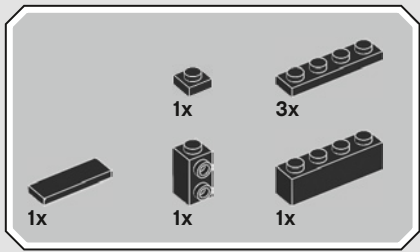

474

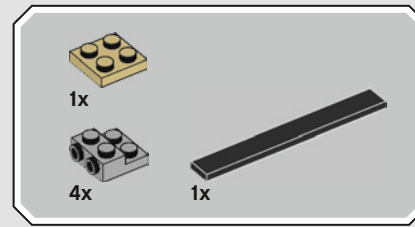
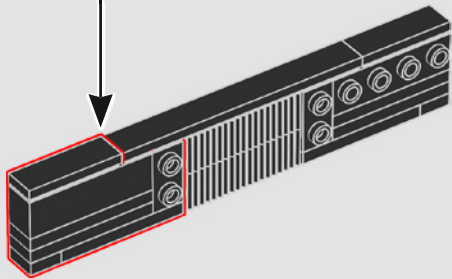
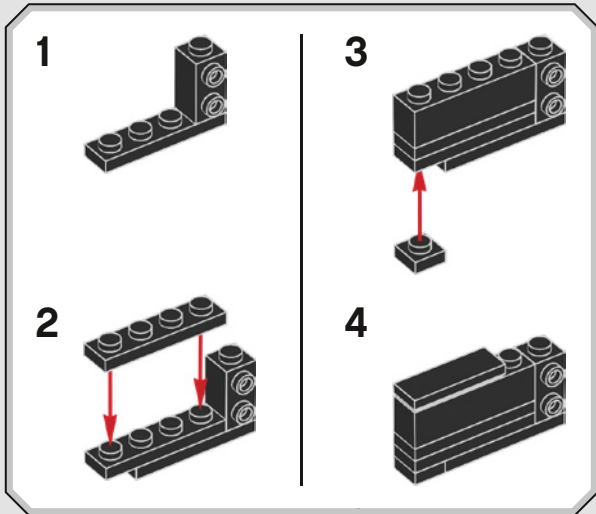

475

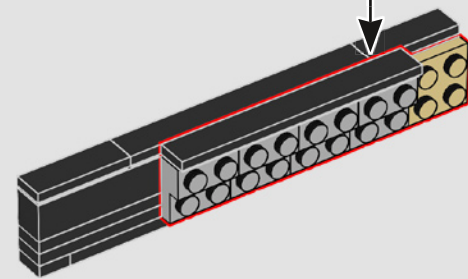
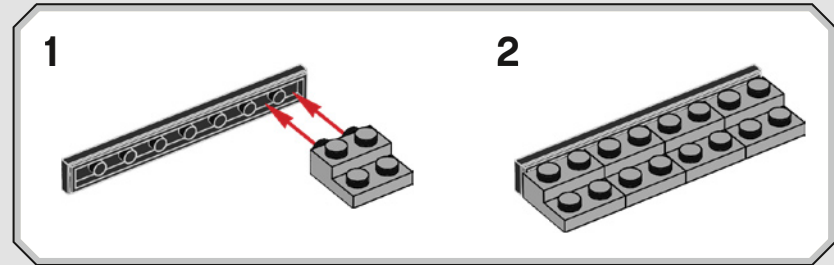



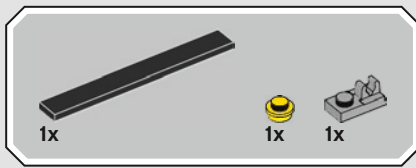

476

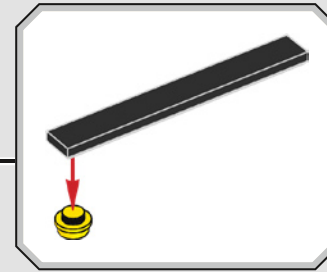
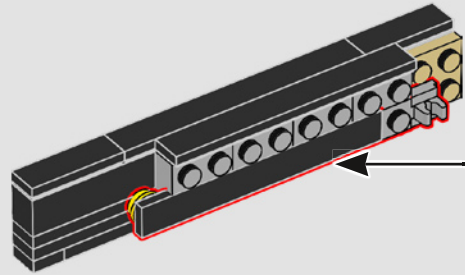

477

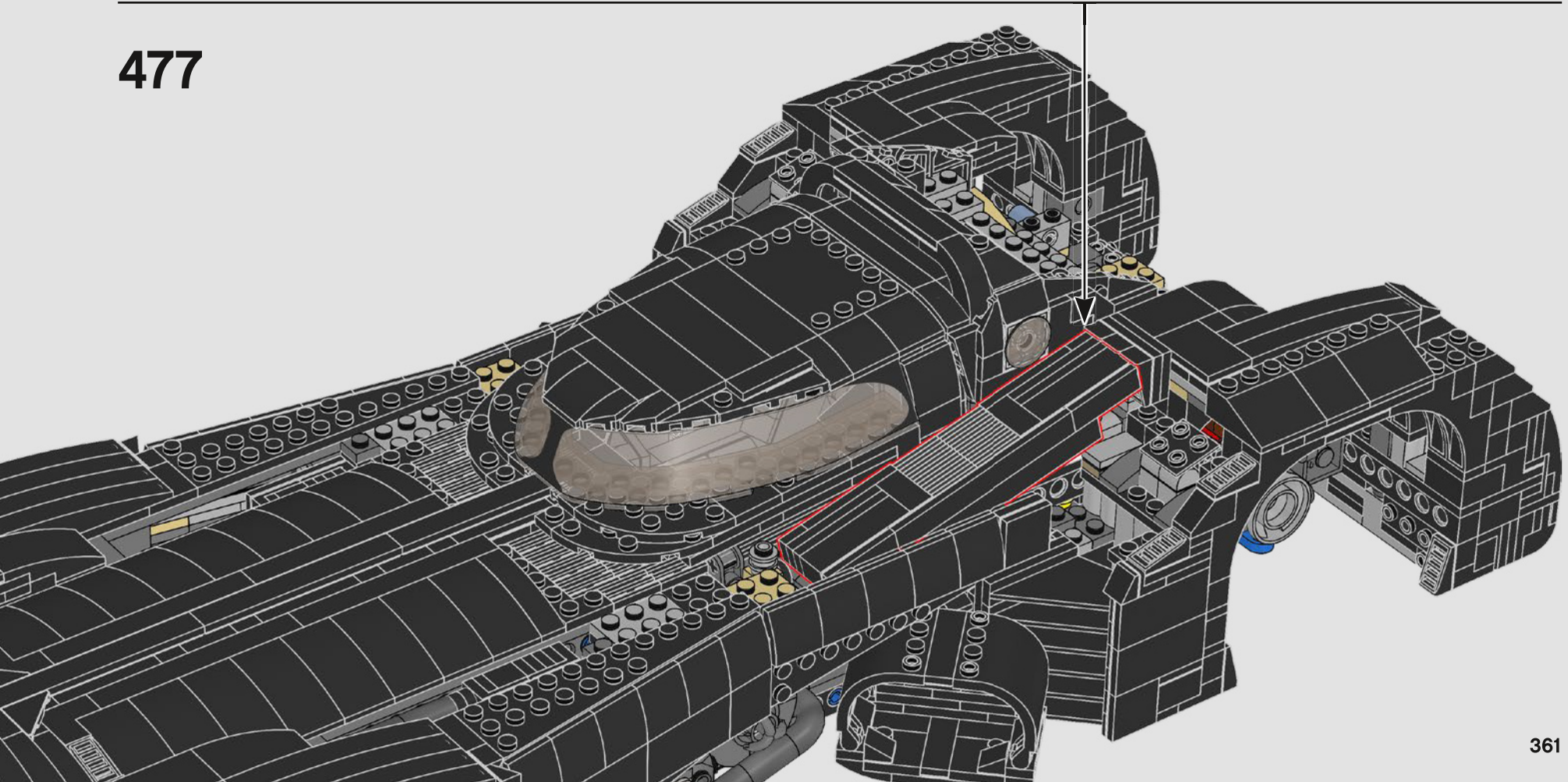

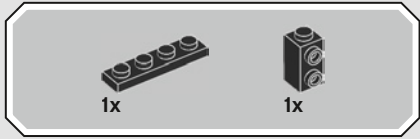
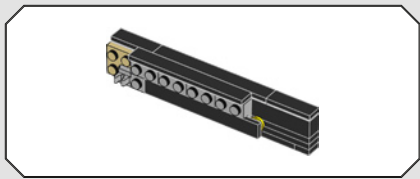

478

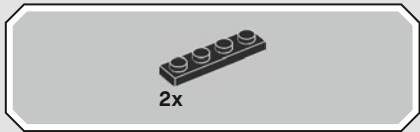
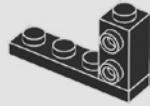

479

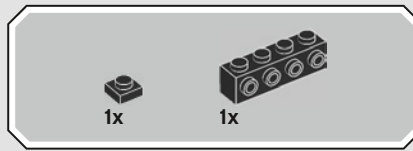
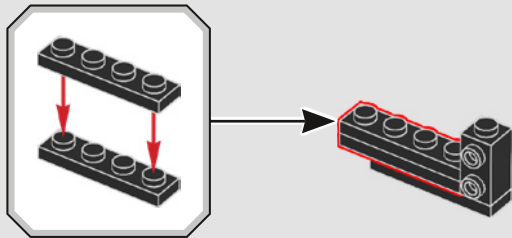

480

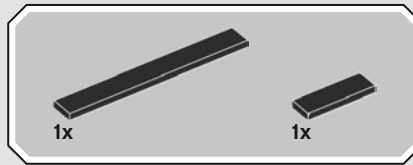
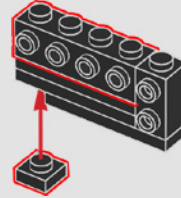

481

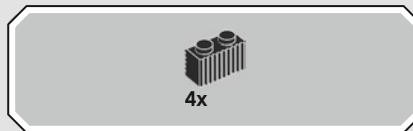
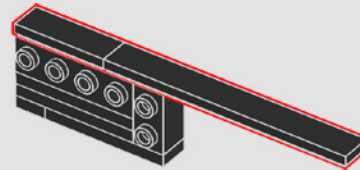

482

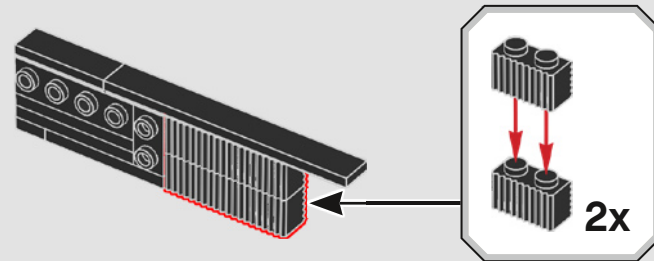

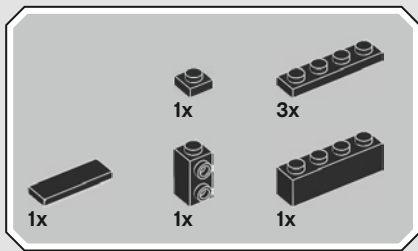

483

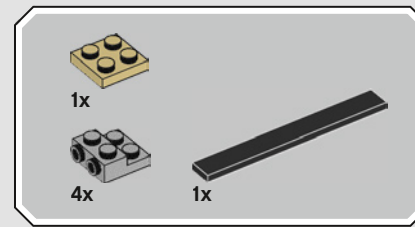
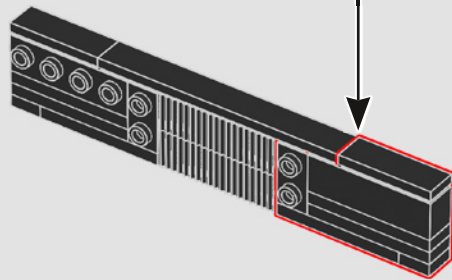
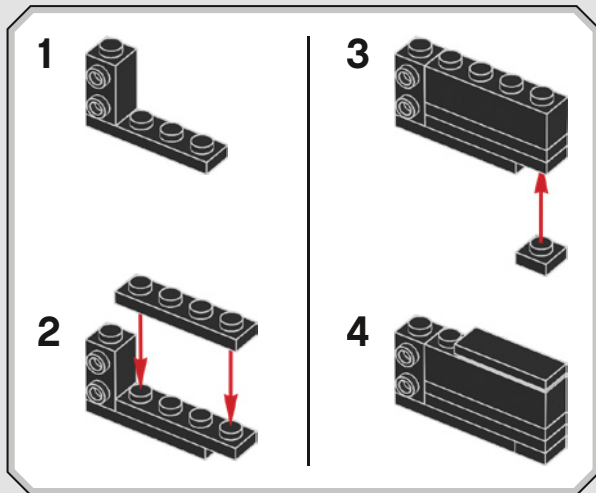

484

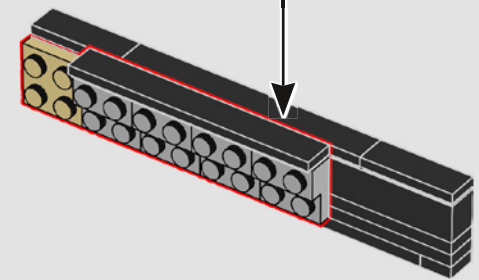
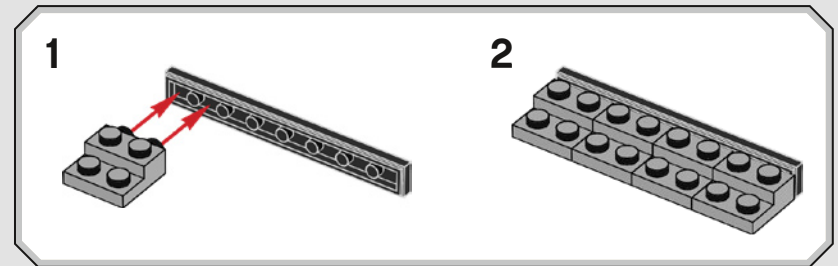

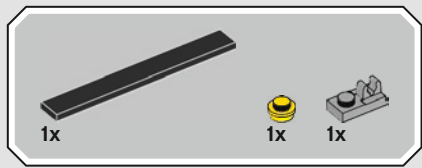

485

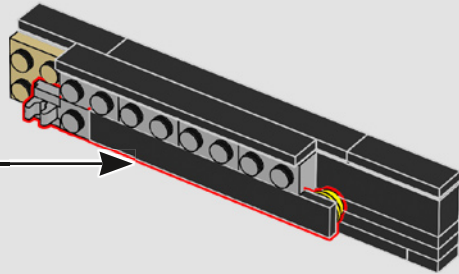
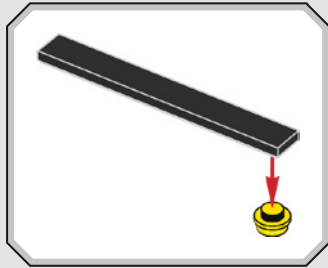

486

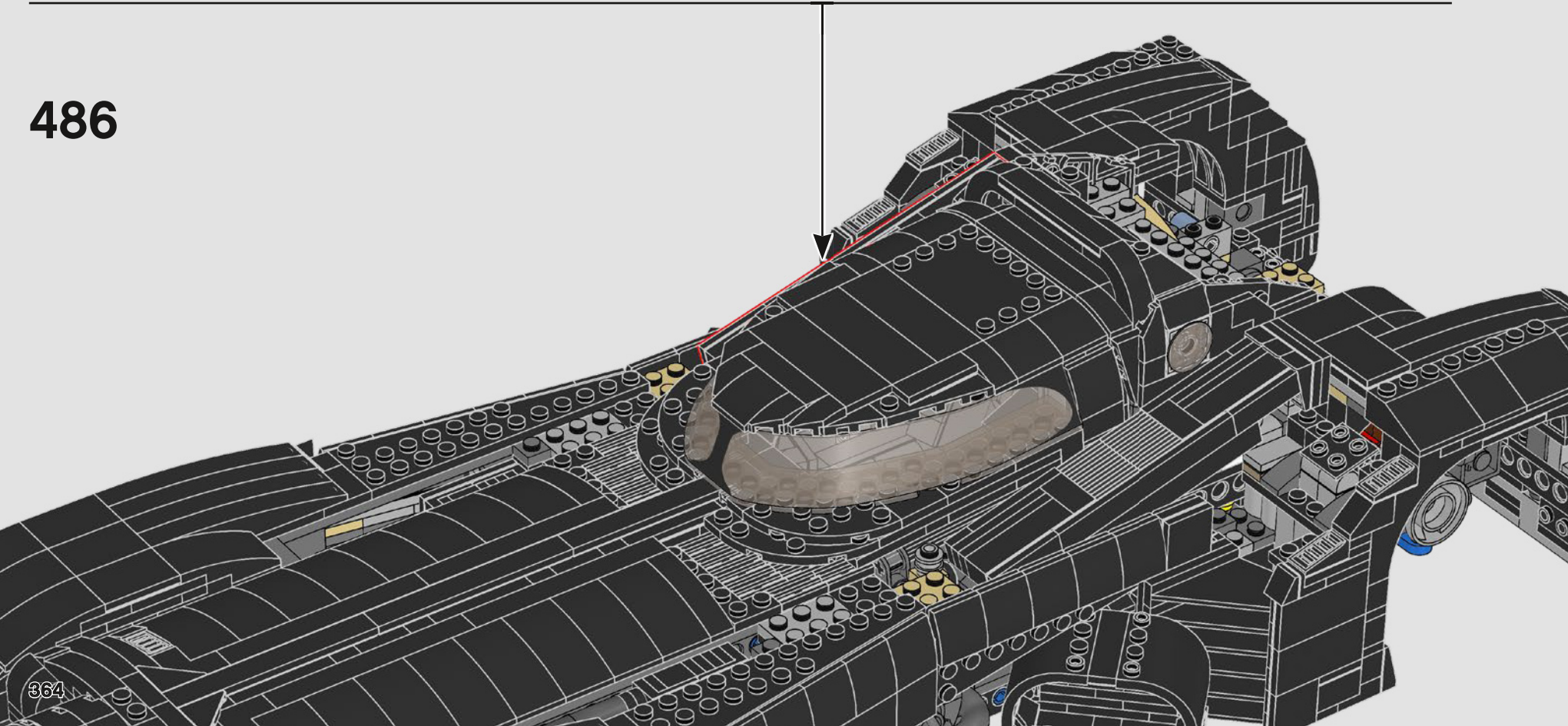

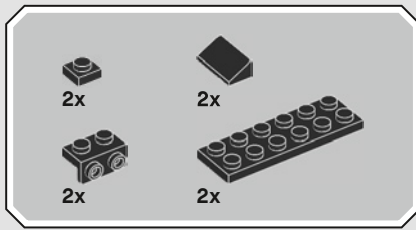

487

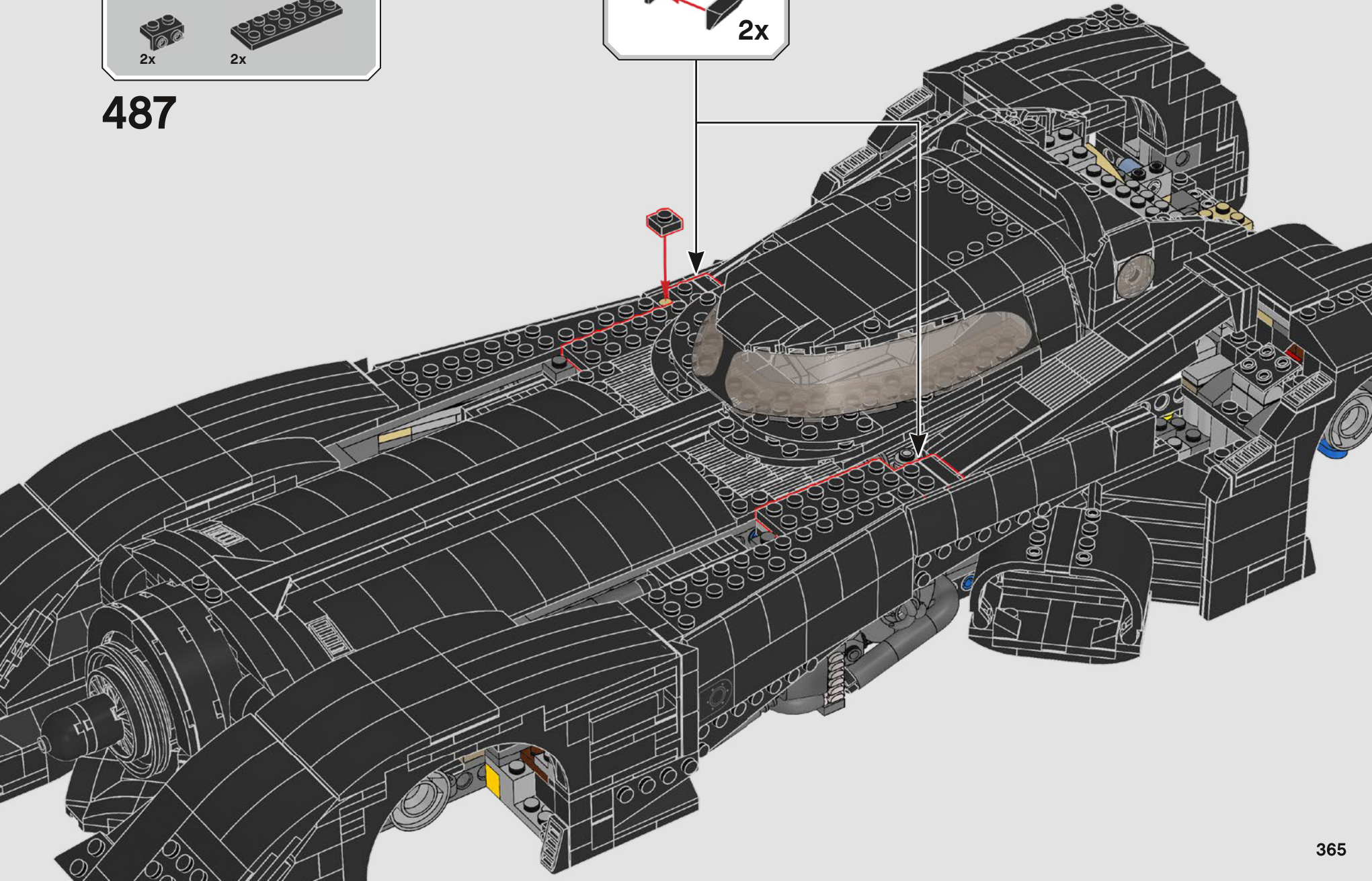
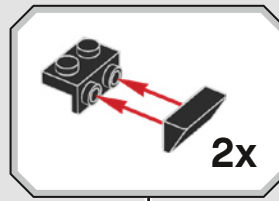

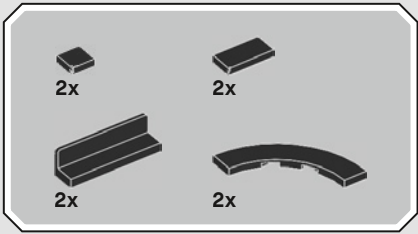

488

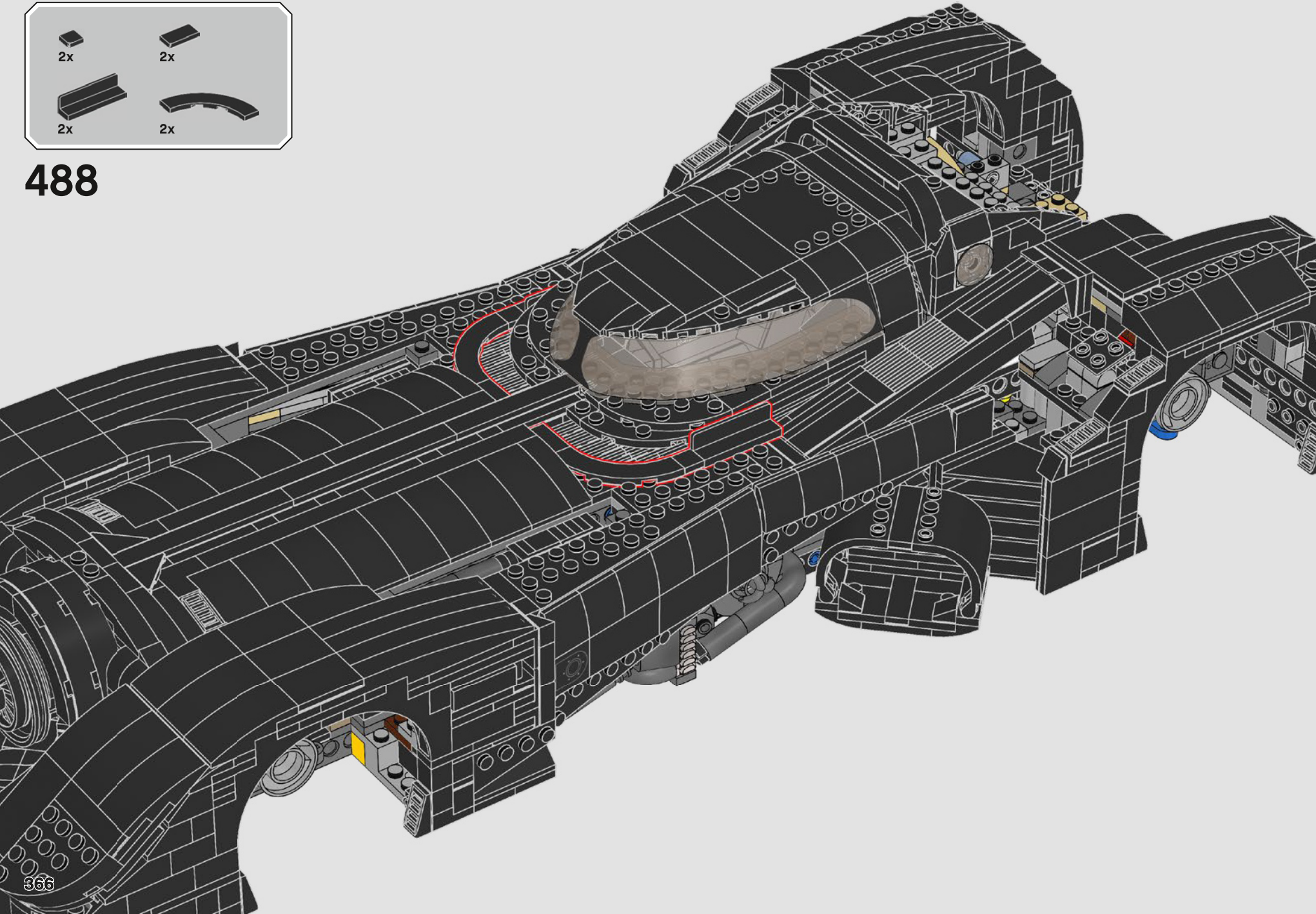

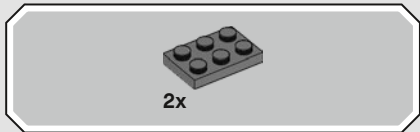
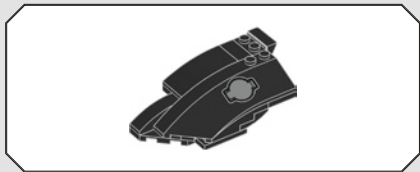
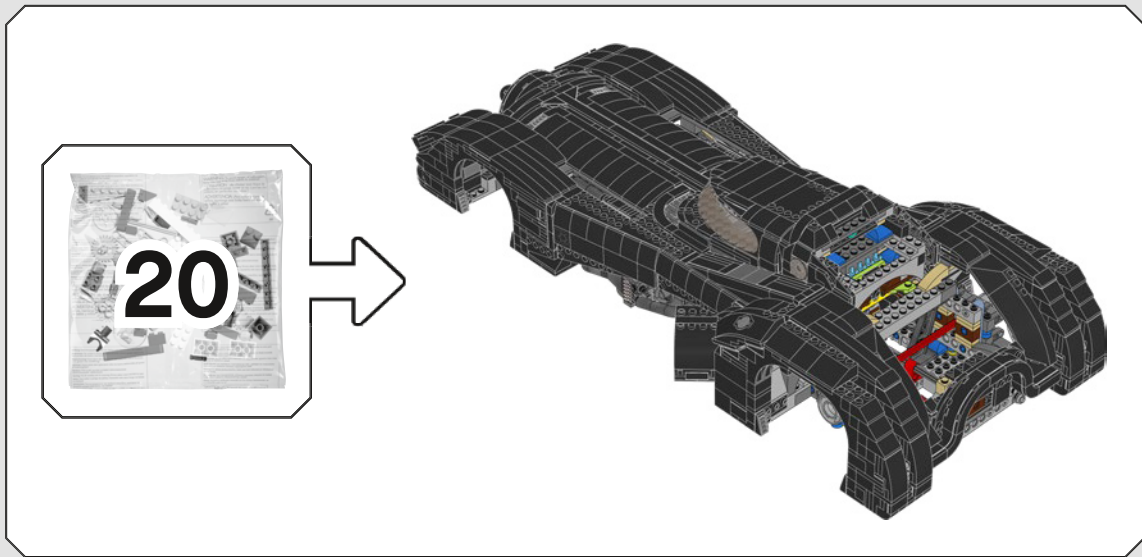

**489**

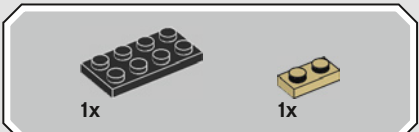
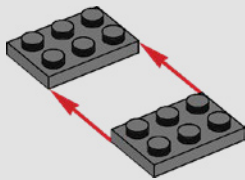

**490**

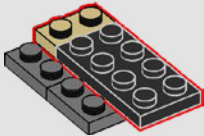

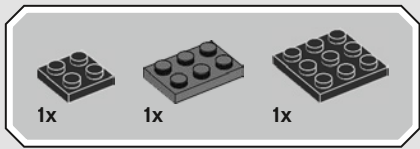

491

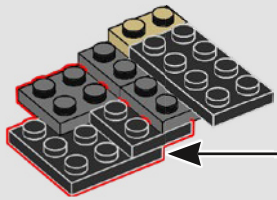
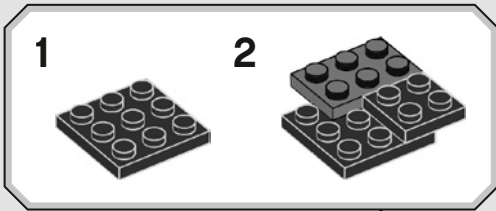

492

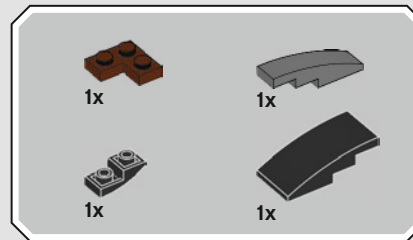
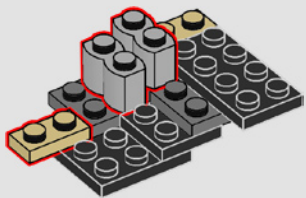

493

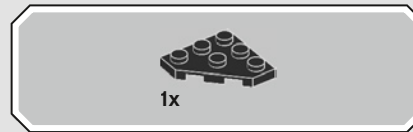
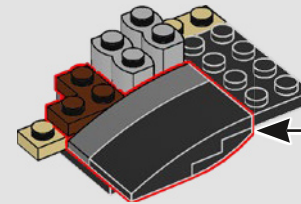
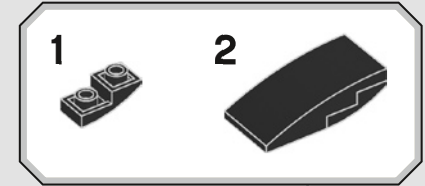

494

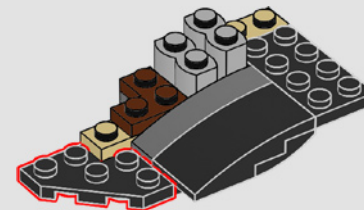



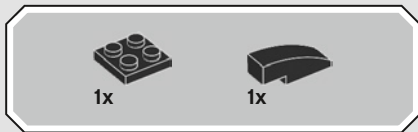

495

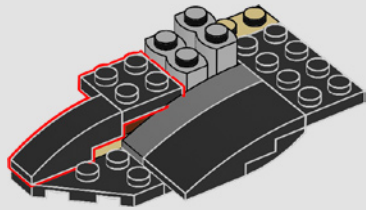

496

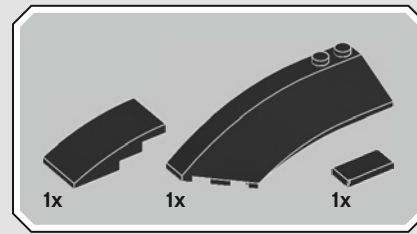
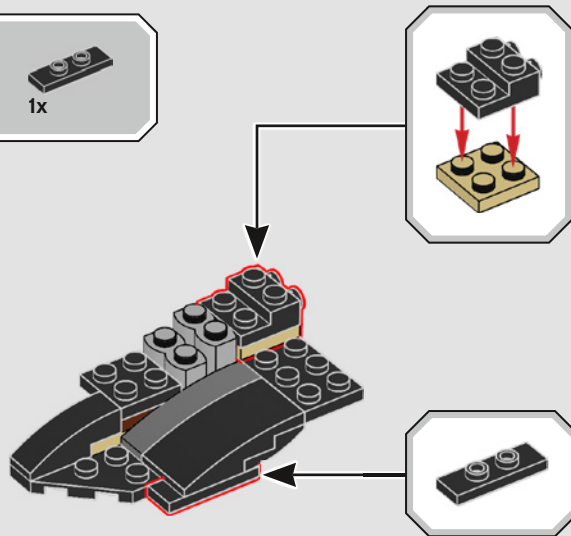

497

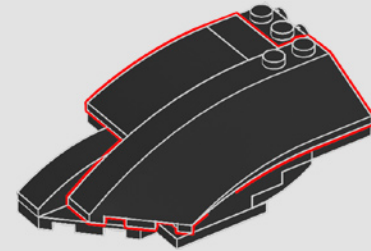

498

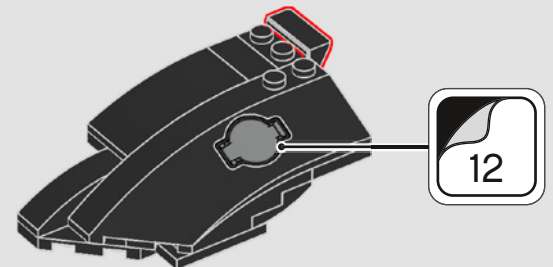

499

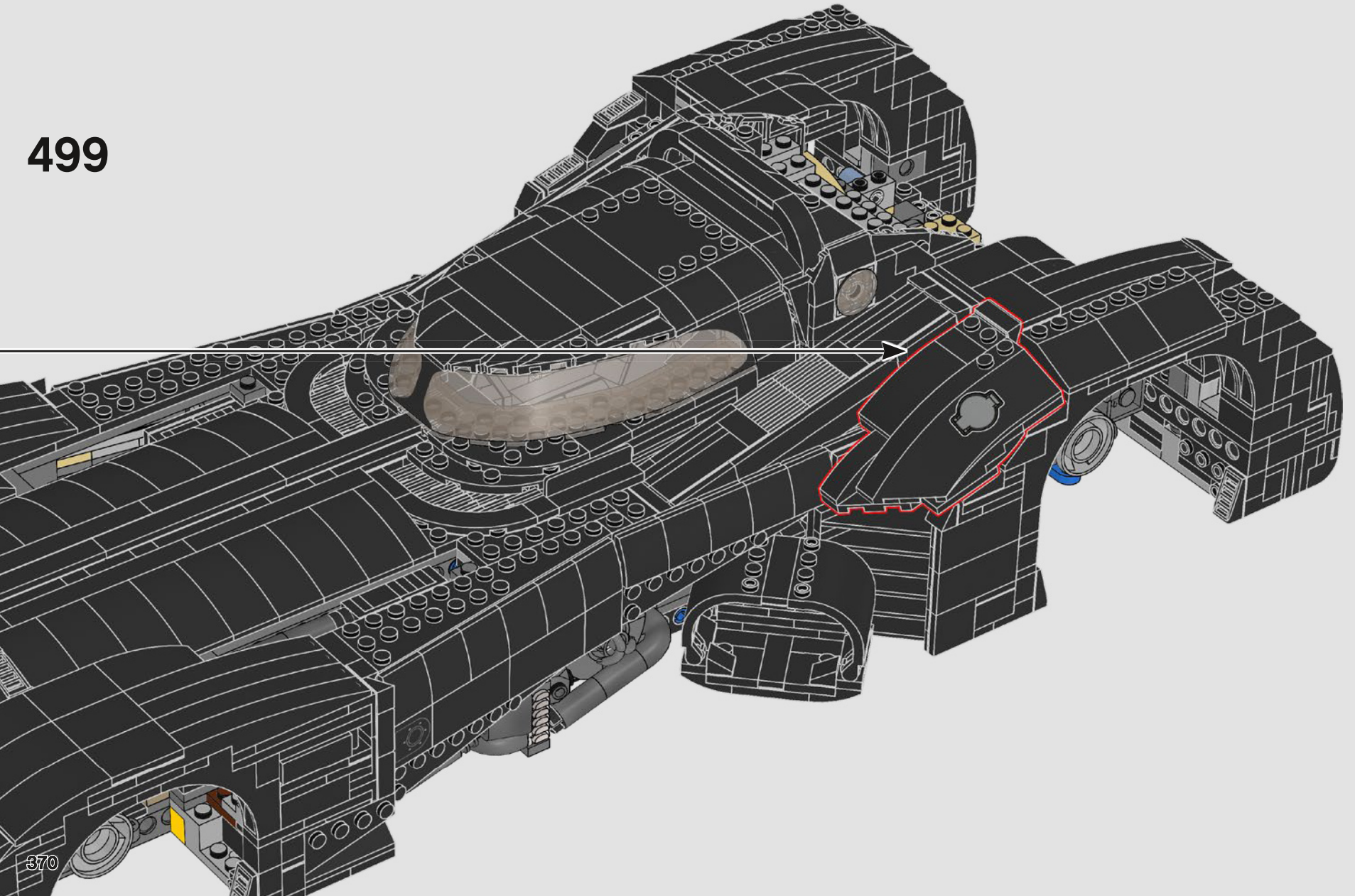

370

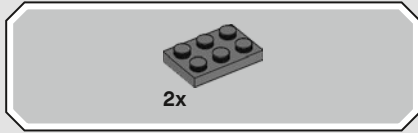
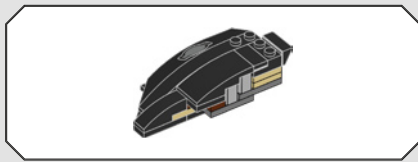

500

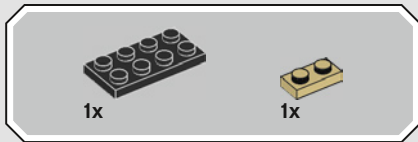
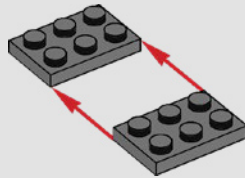

501

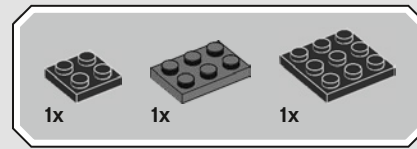
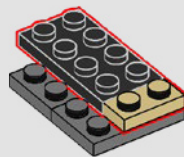

502

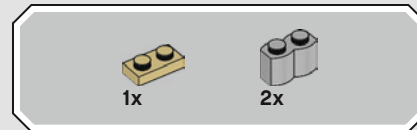
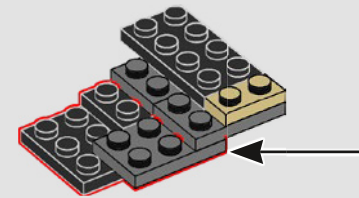
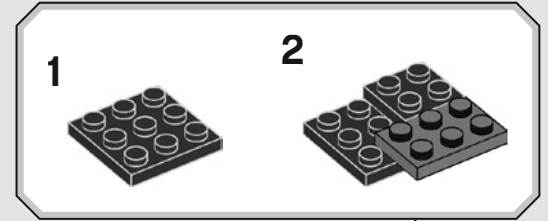

503

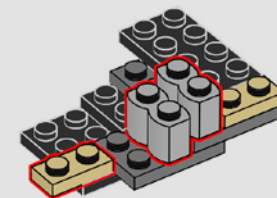

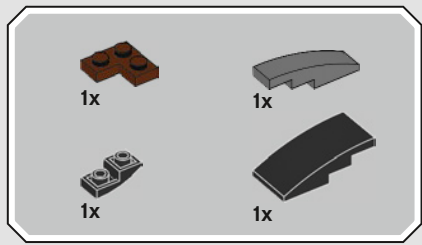

504

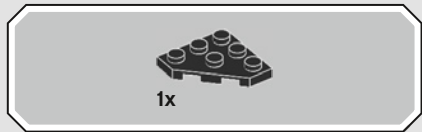
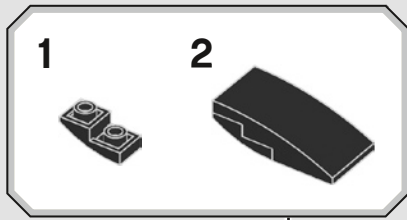
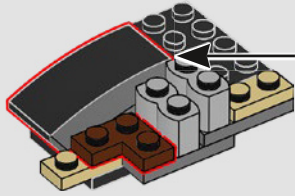

505

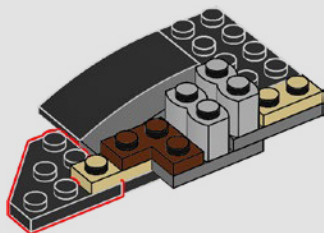

506

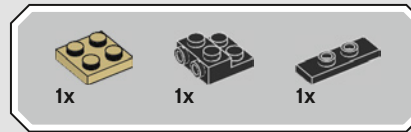
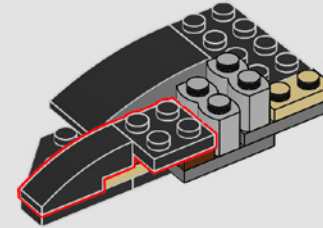

507

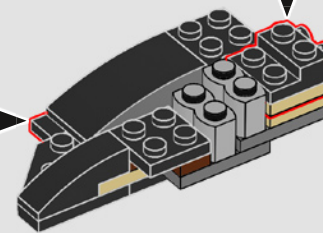
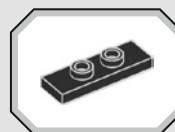
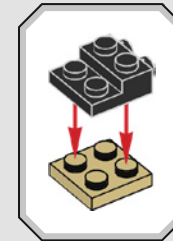

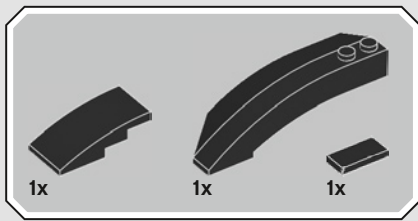

508

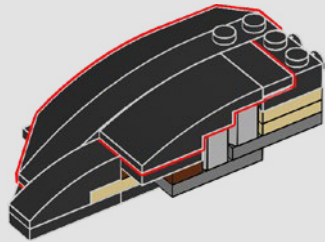

509

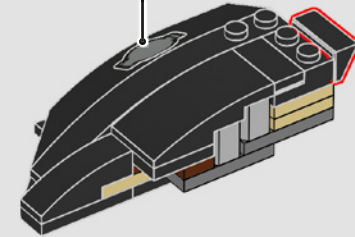

510

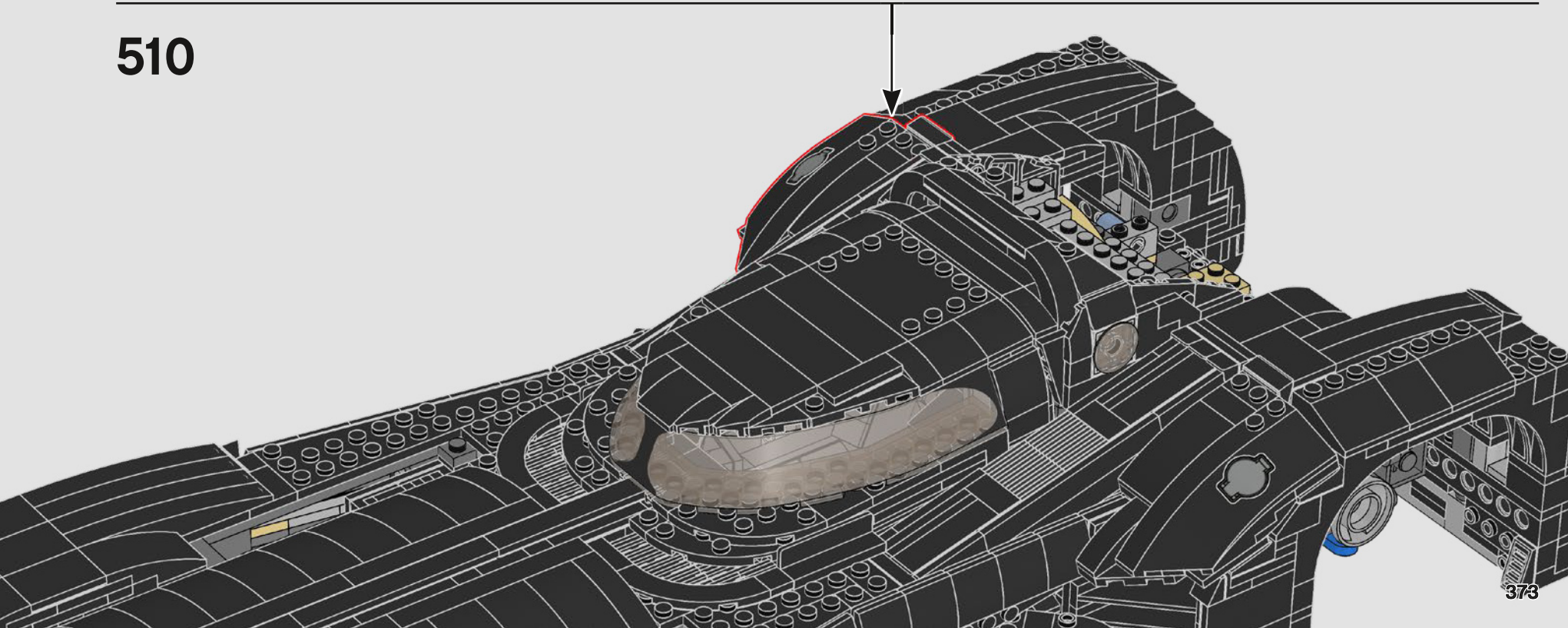



511

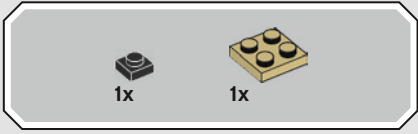
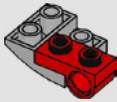

512

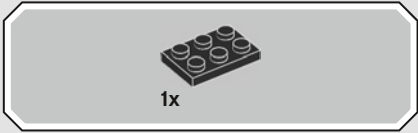
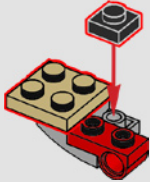

513

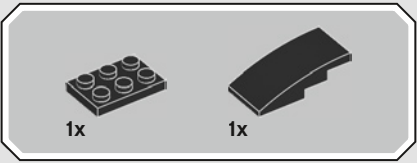
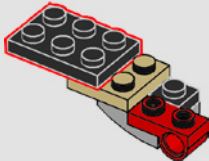

514

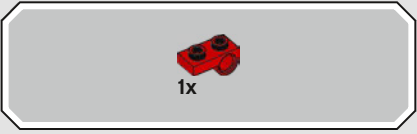
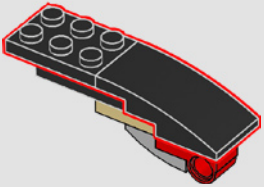

515

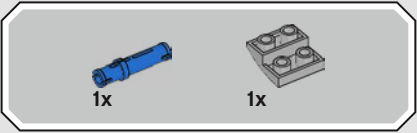
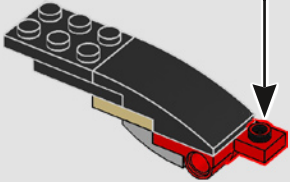

516

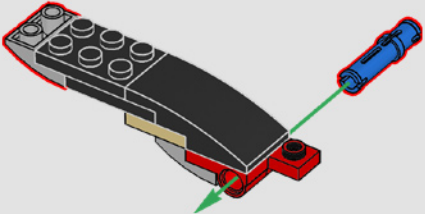

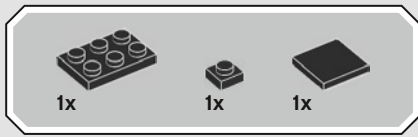

517

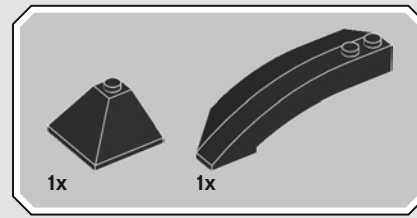
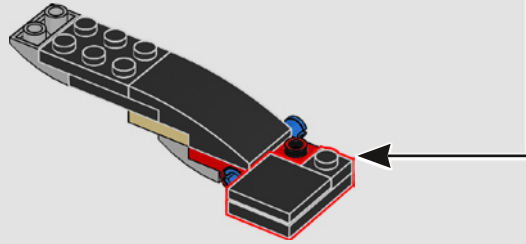
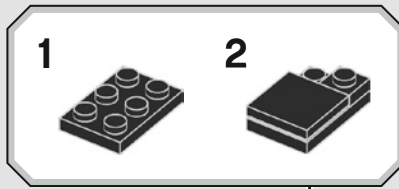

518

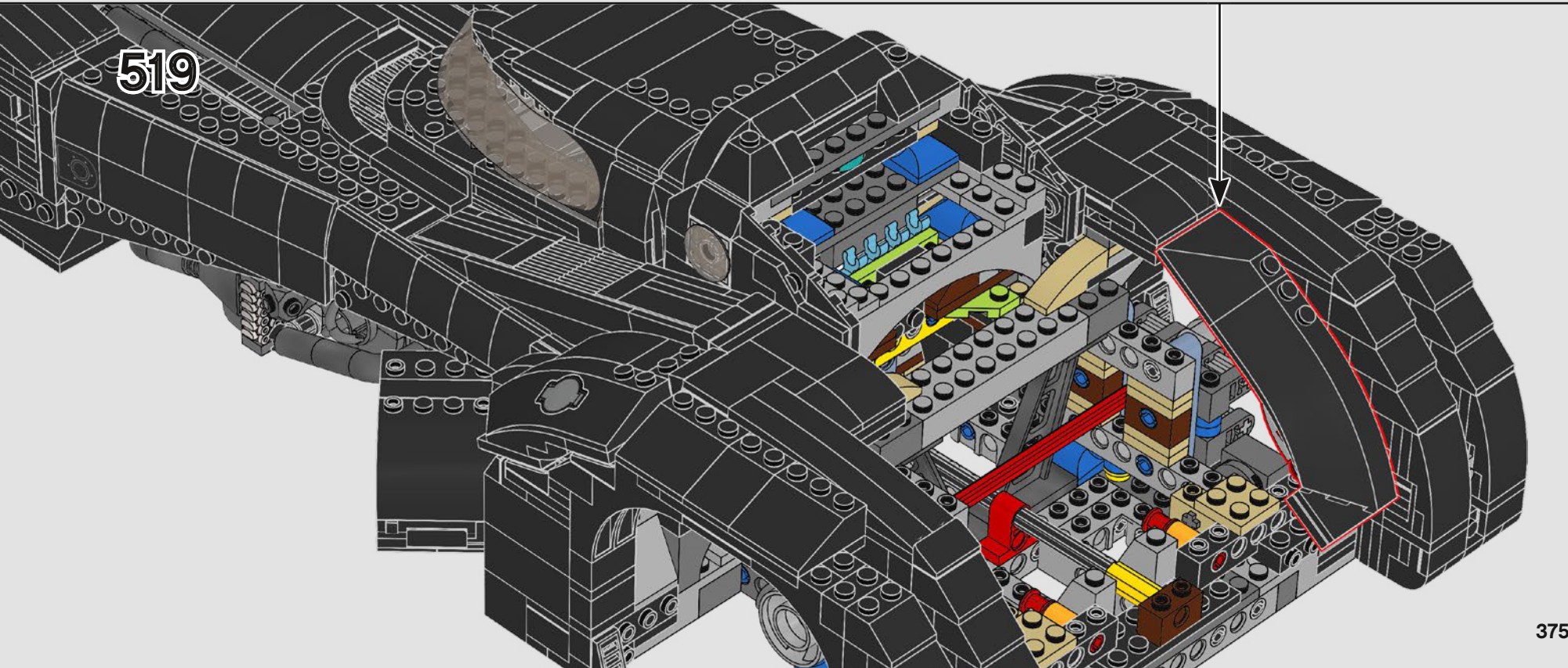
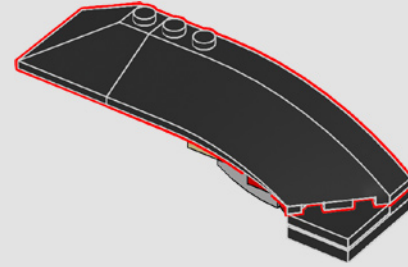



520

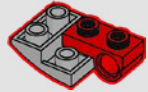

521

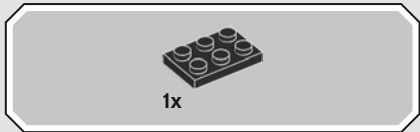
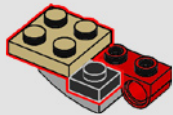

522

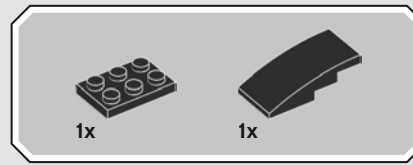
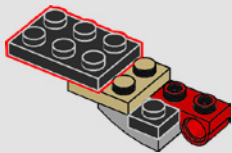

523

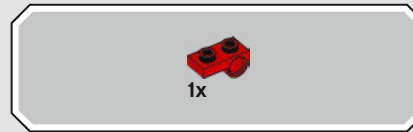
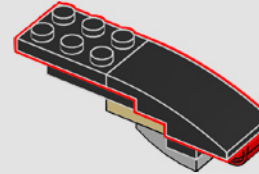

524

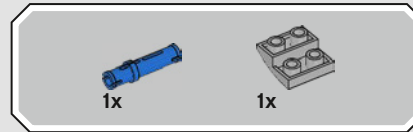
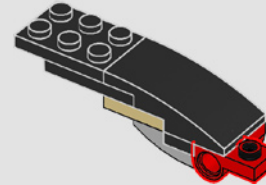

525

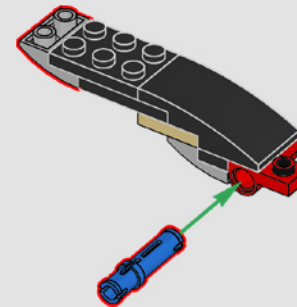





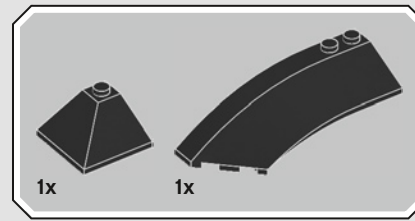
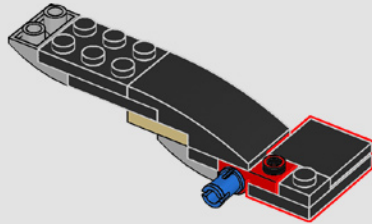
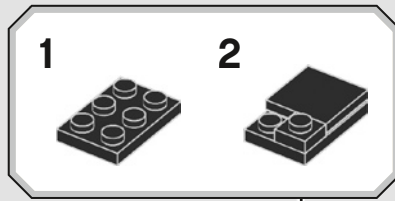

526

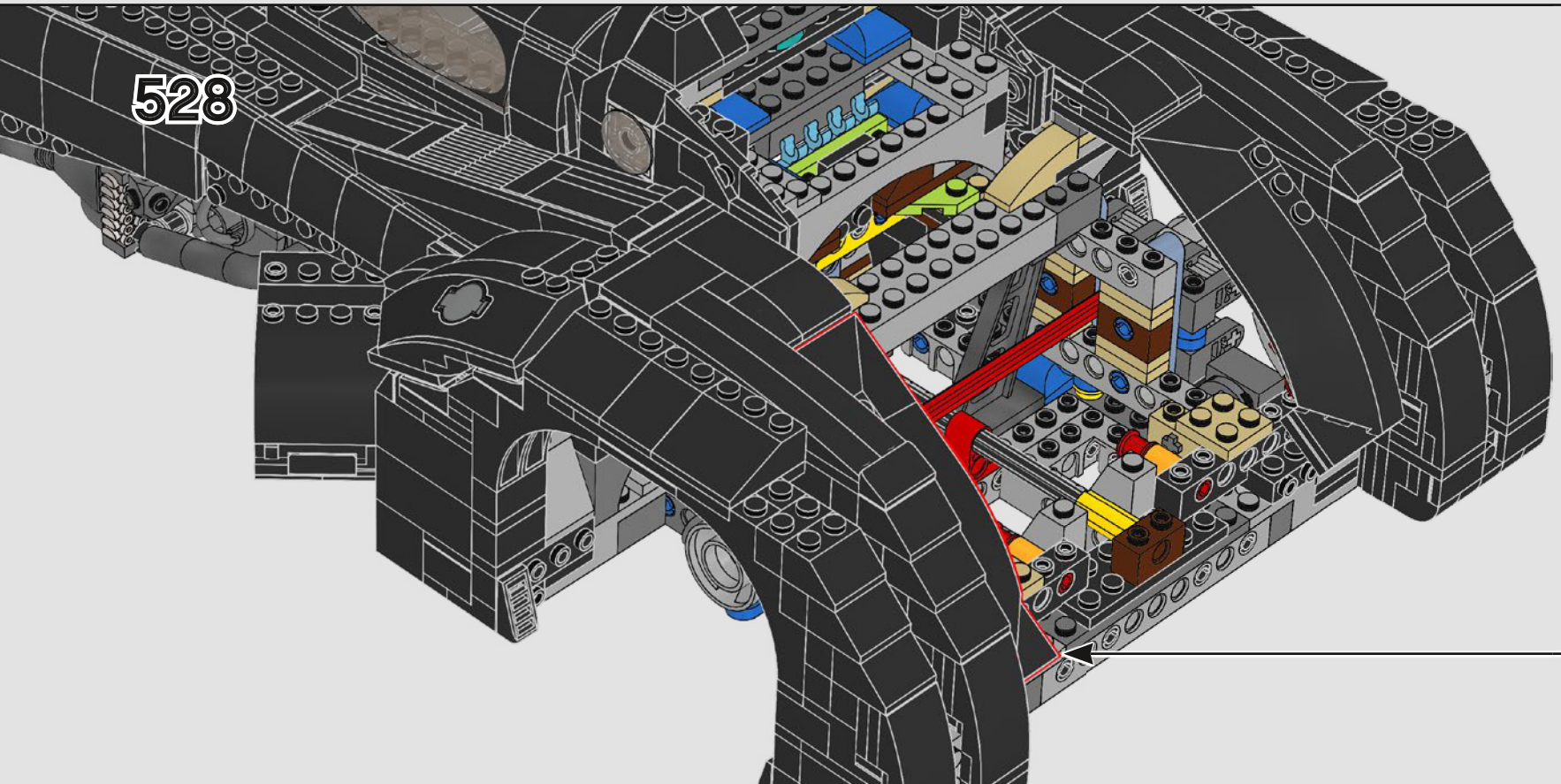
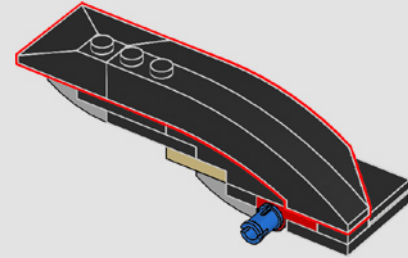

527



		
1x	2x	2x

529

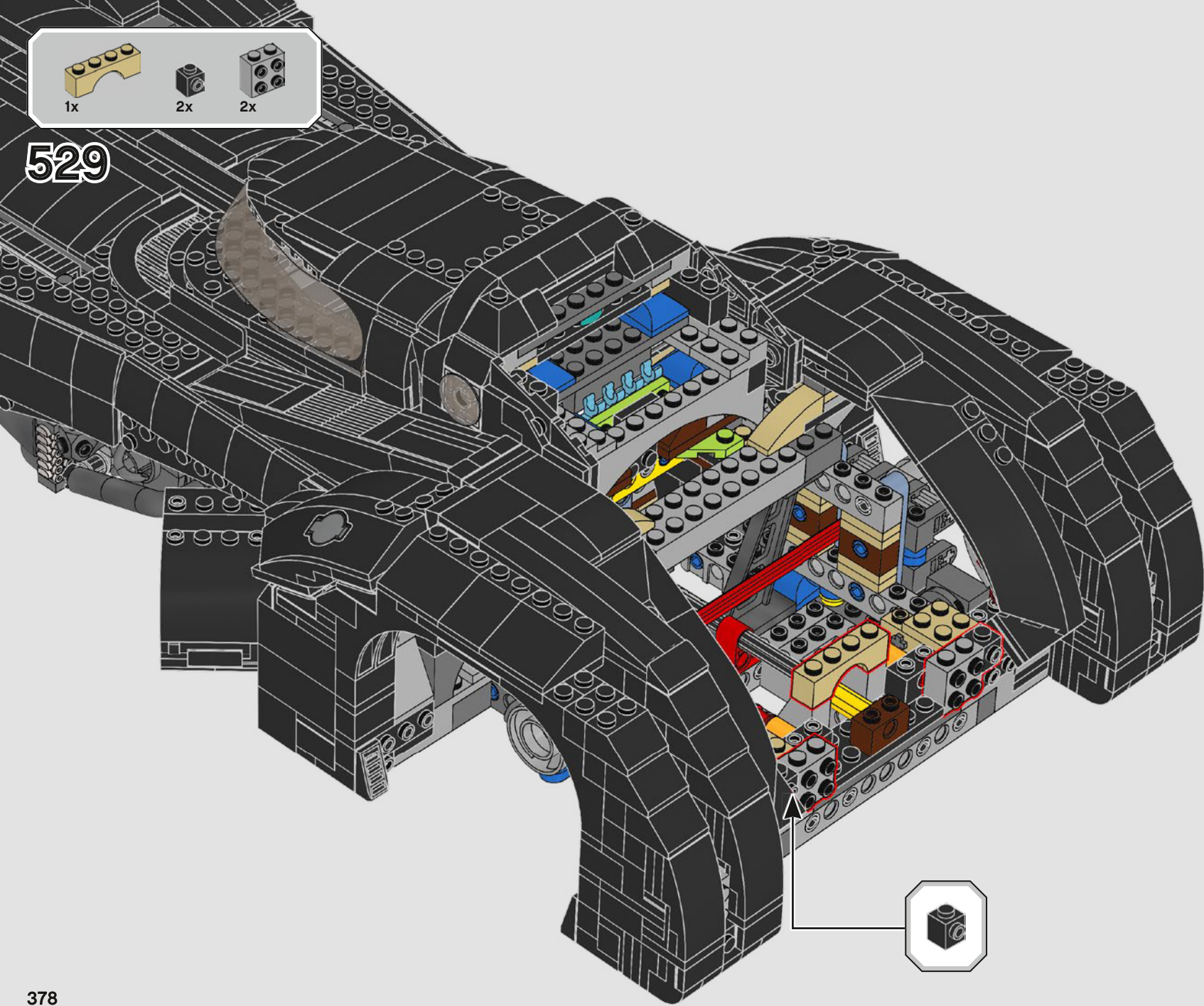



4x



2x

530

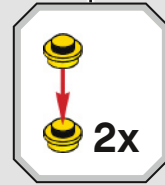
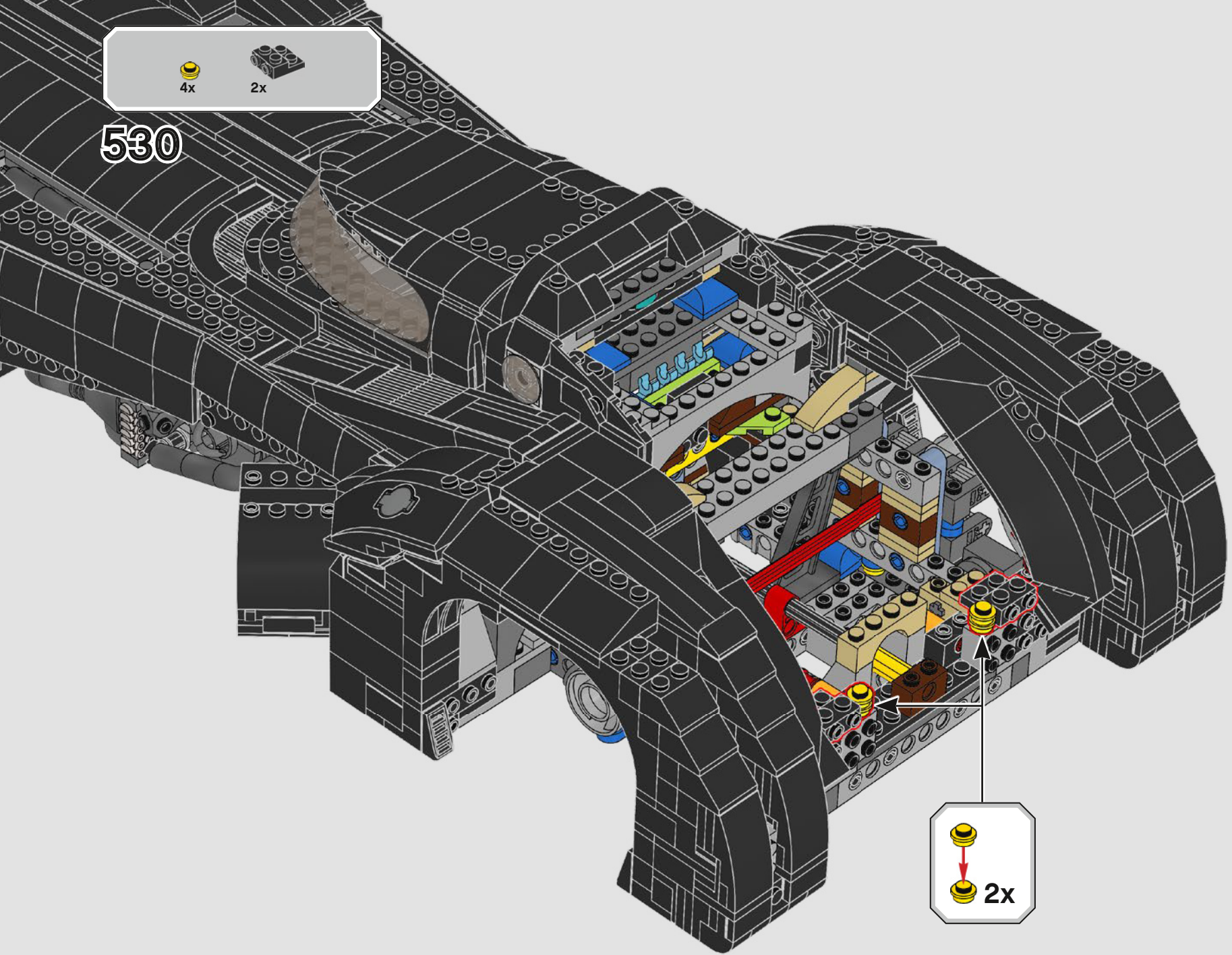

2x

4x 2x 2x

531

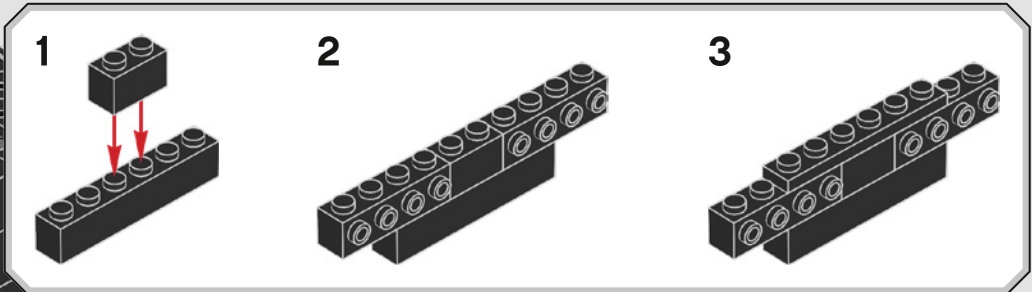
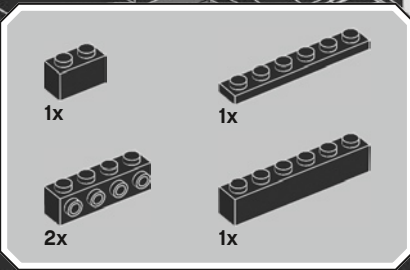

2x

2x



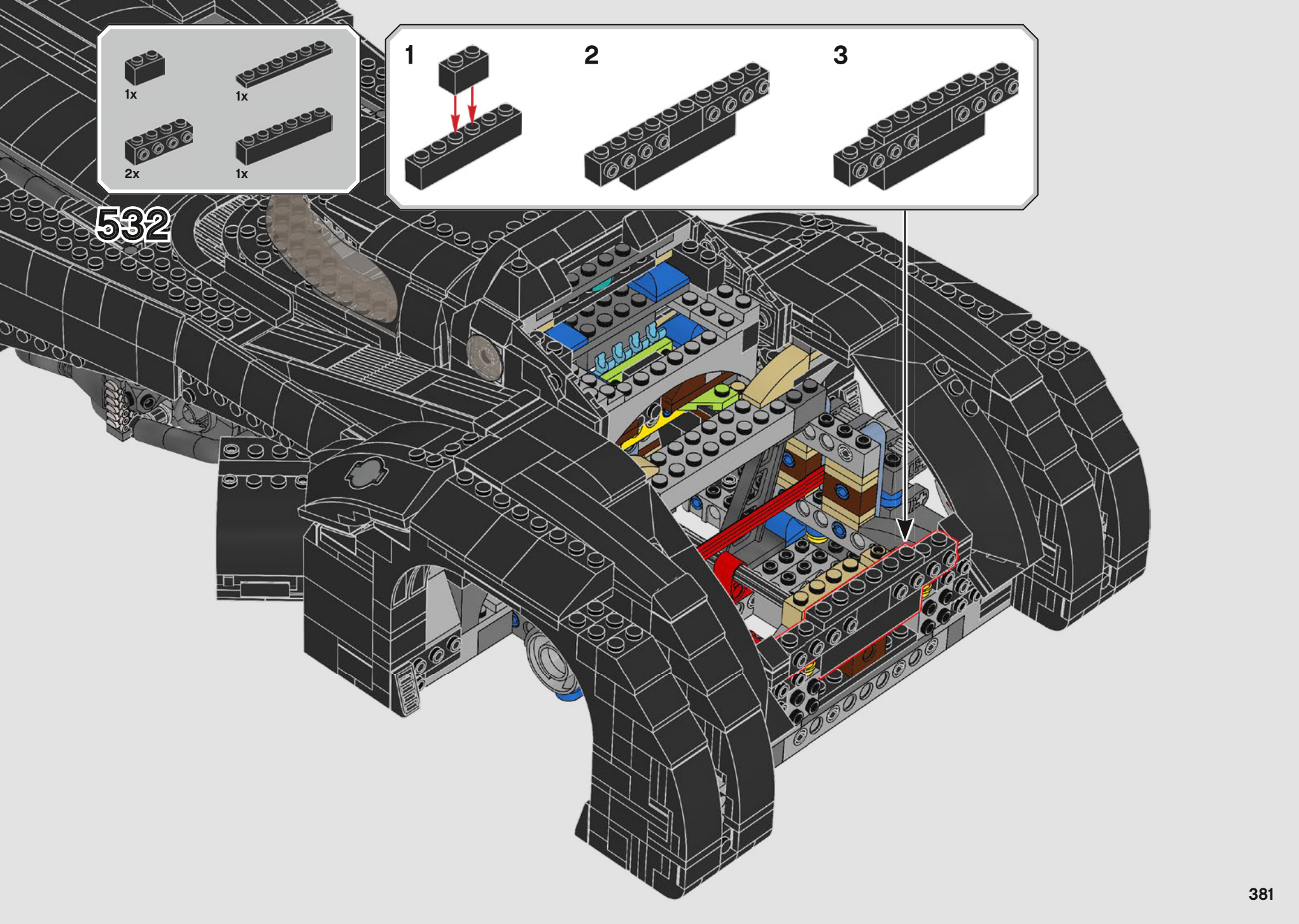





532

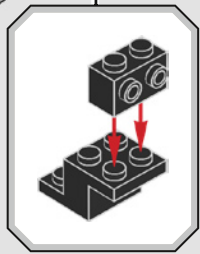
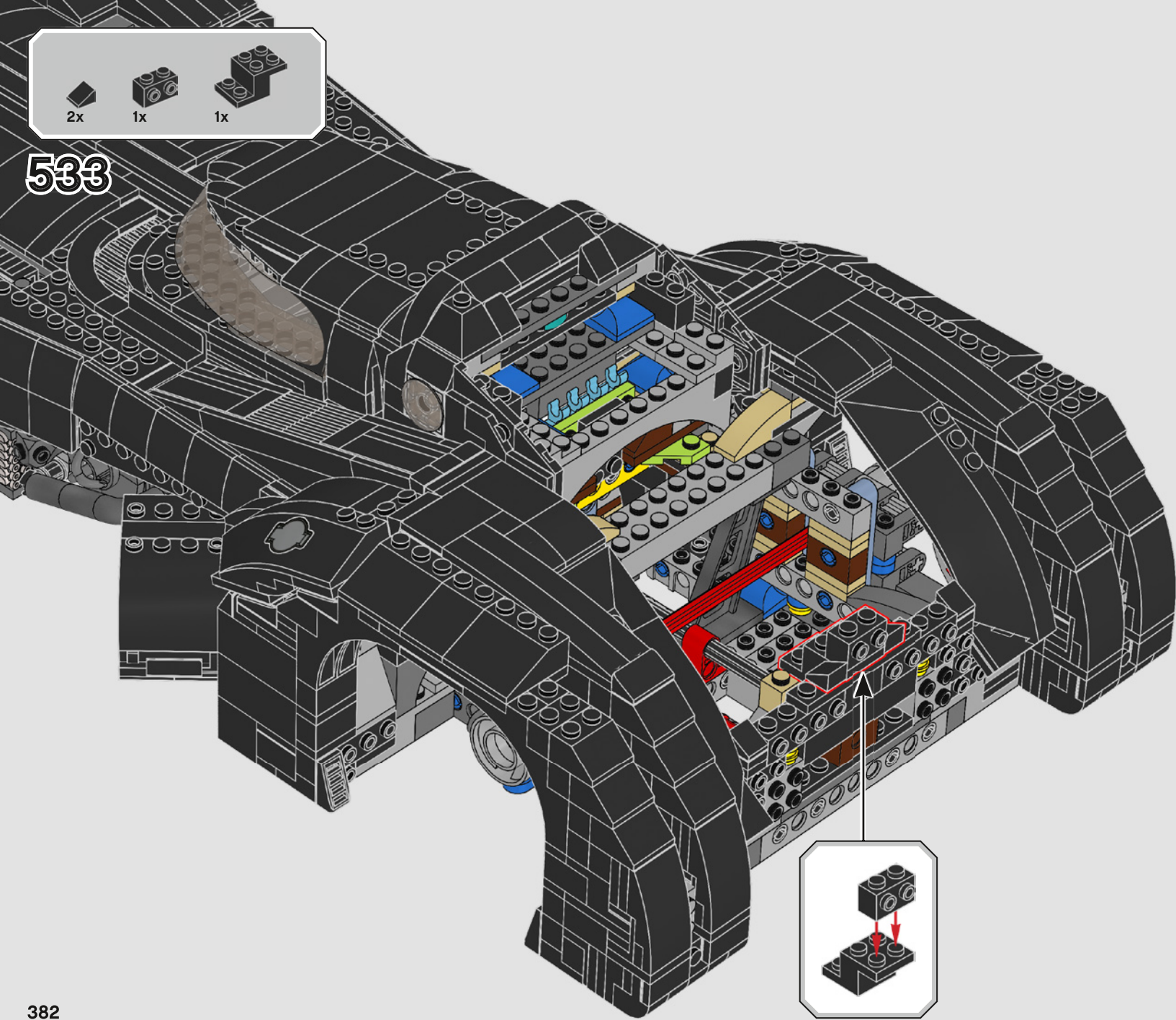

		
2x	1x	1x

533



- 2x 
- 2x 
- 2x 
- 2x 
- 2x 

534

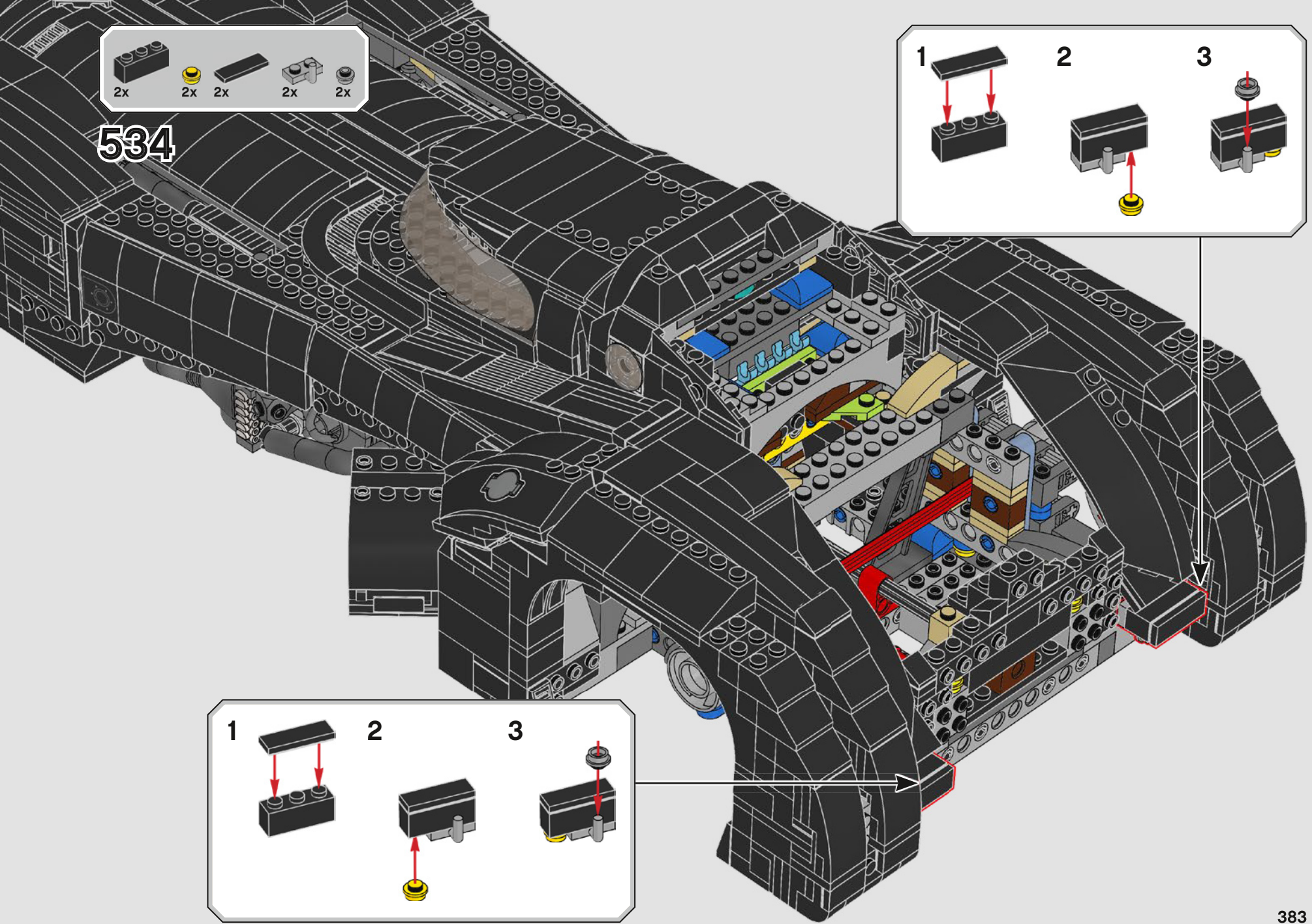
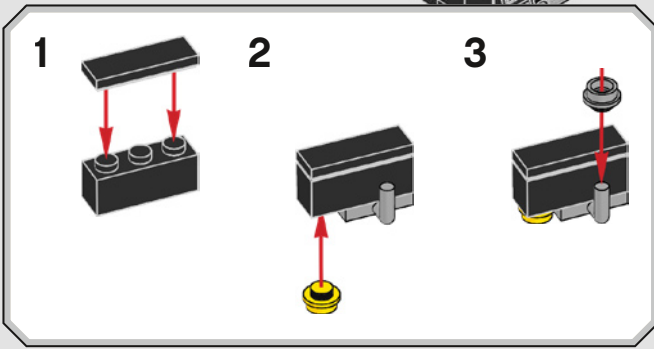
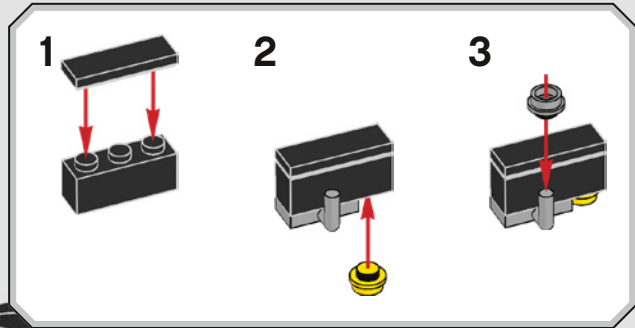

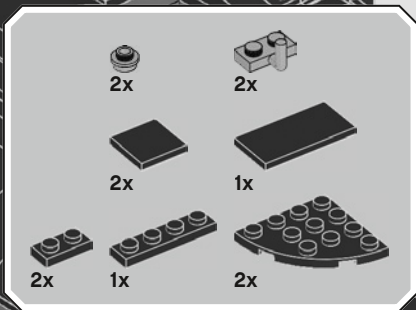

535

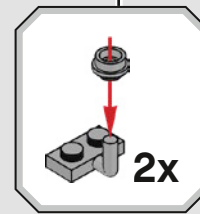
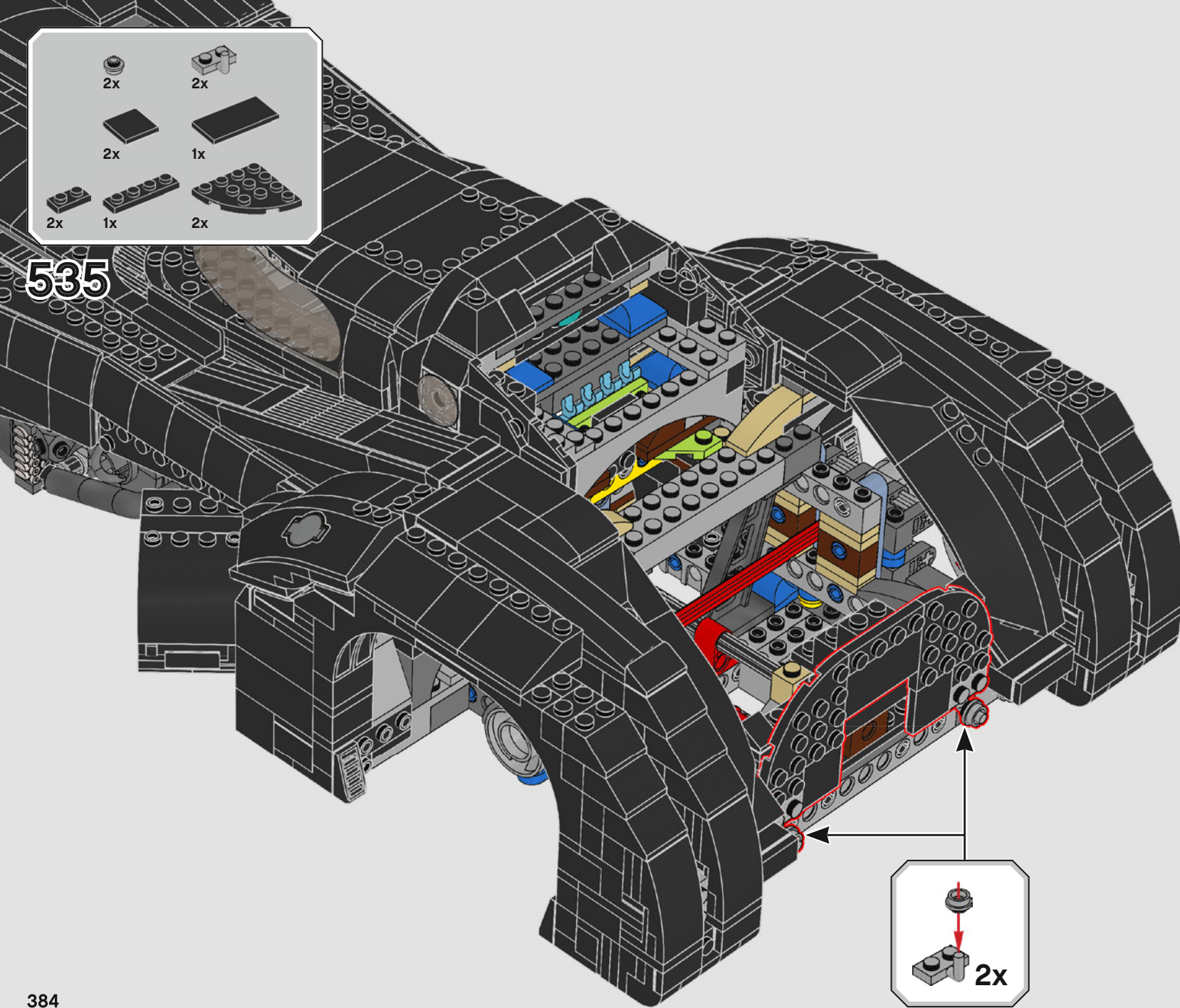



1x	2x	2x

536

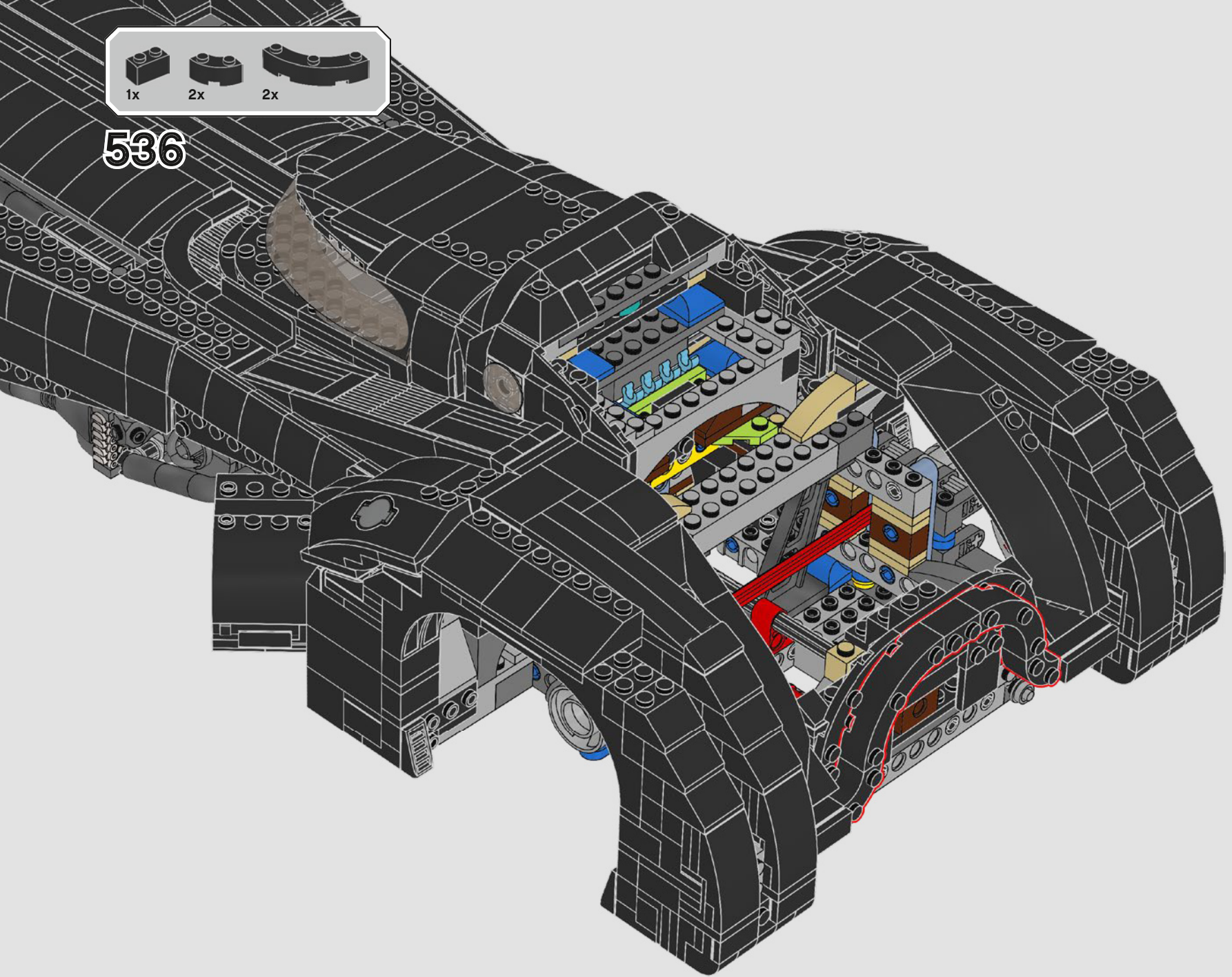

1x 2x 2x

537

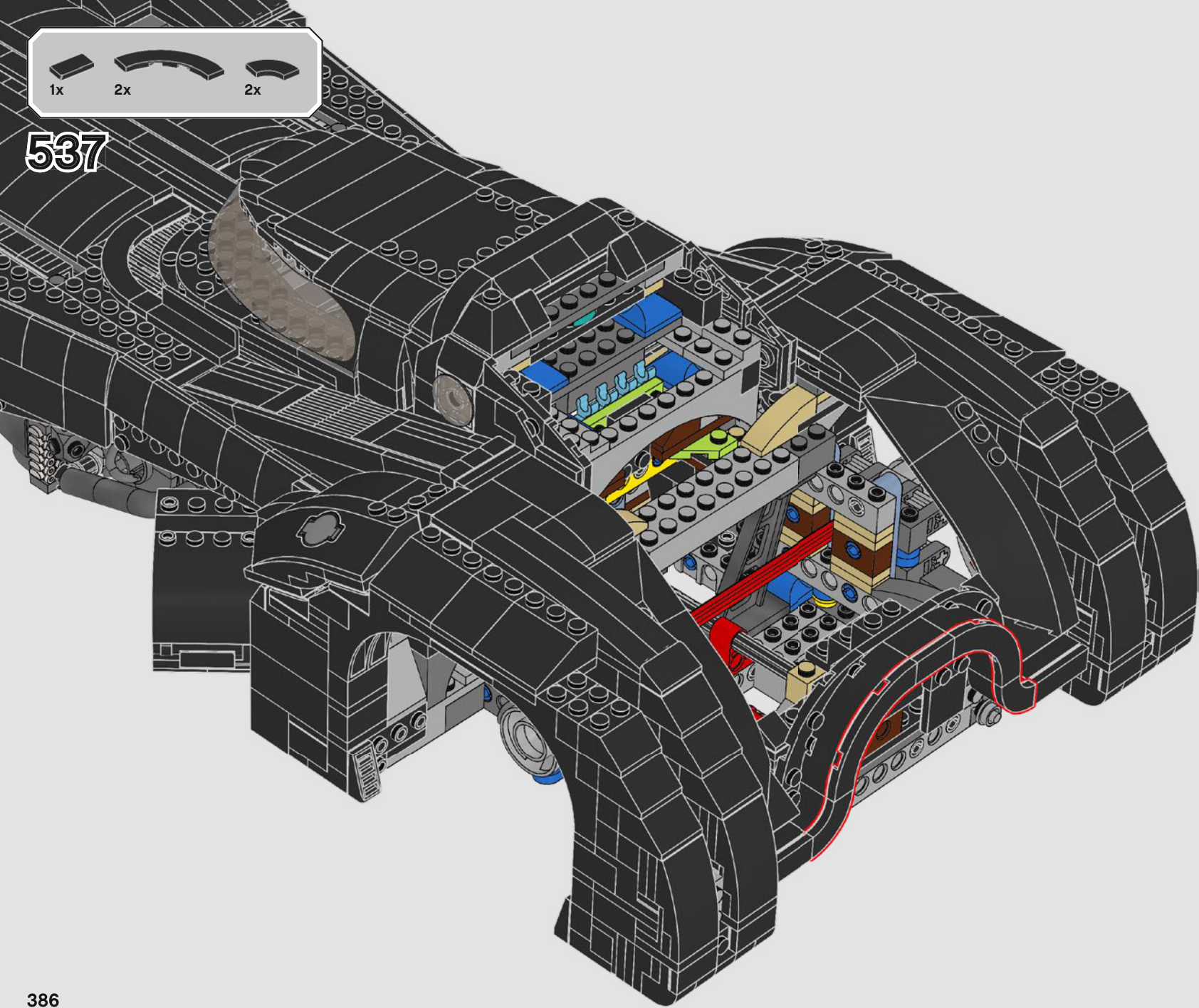

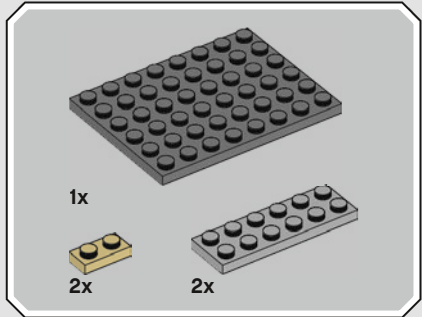
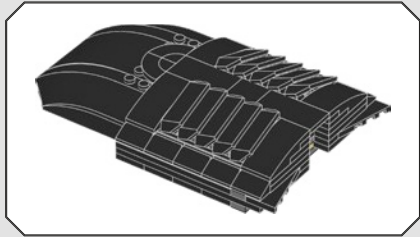
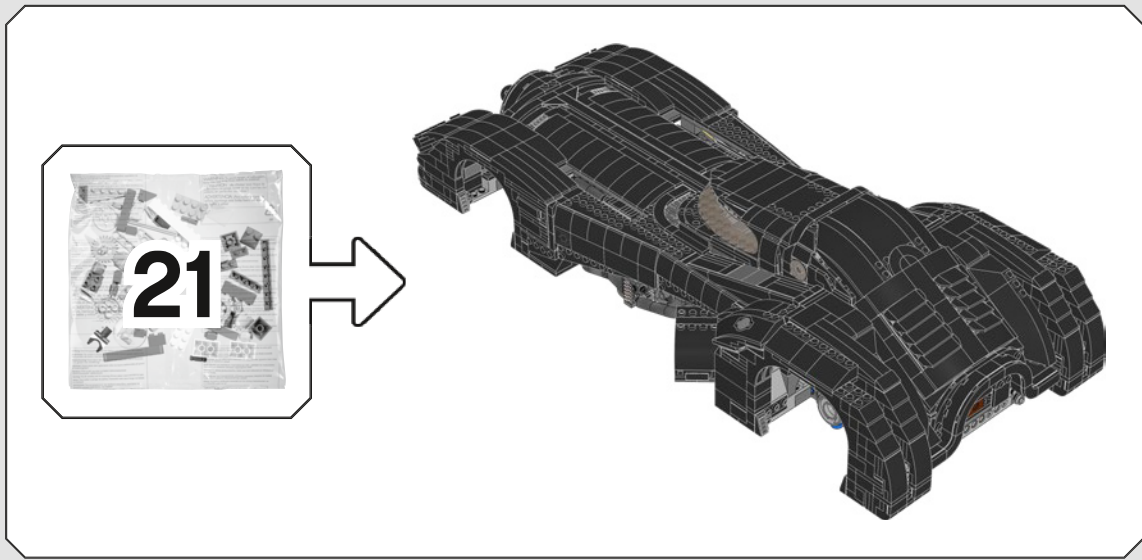

**538**

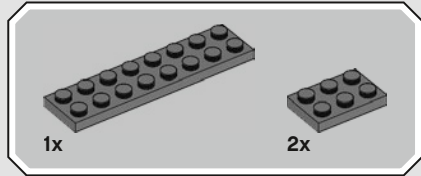
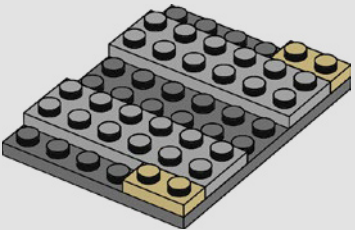

**539**

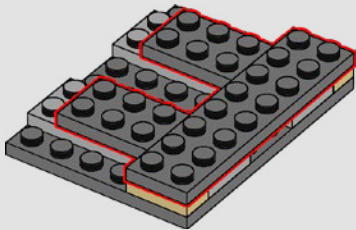

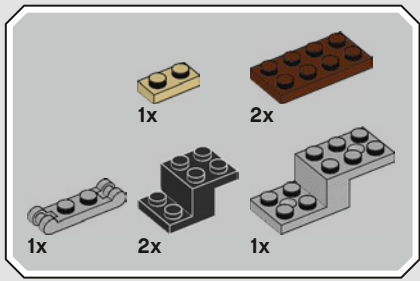

540

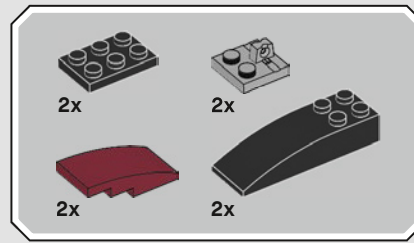
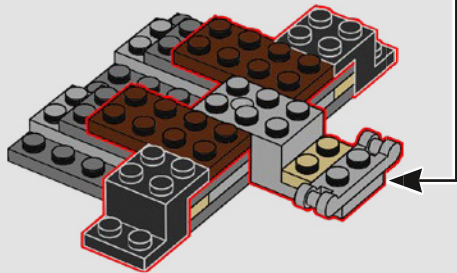
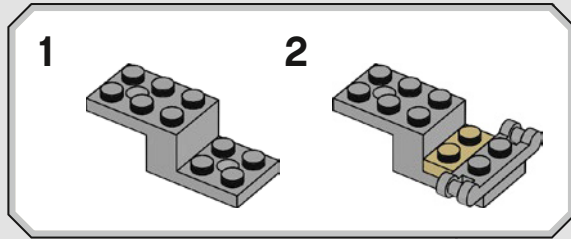

541

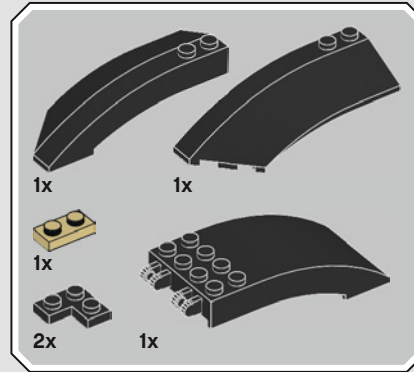
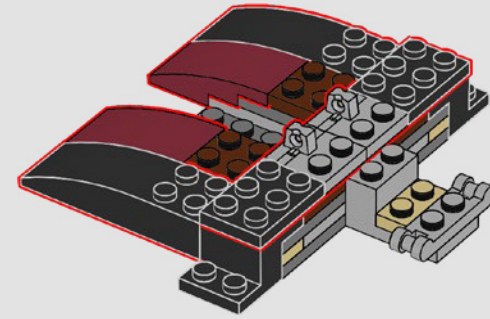

542

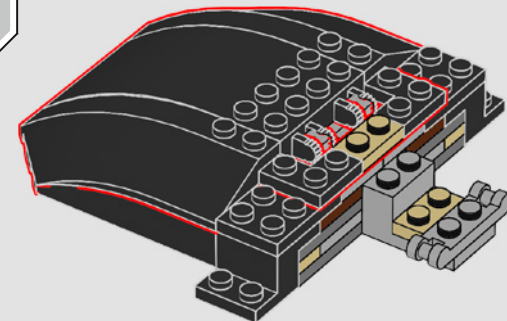

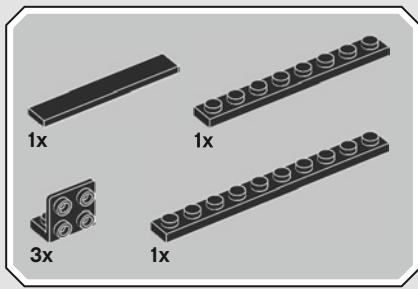

543

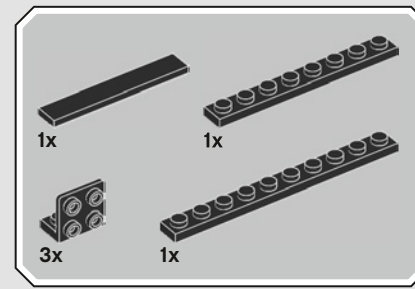
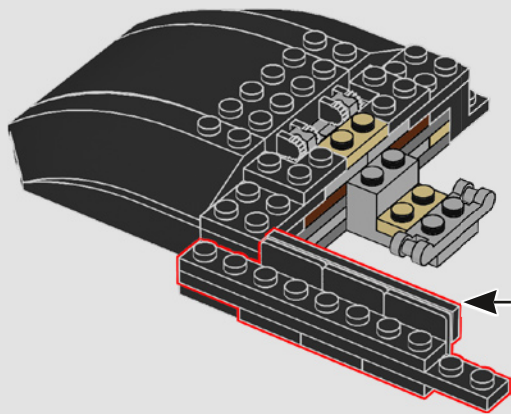
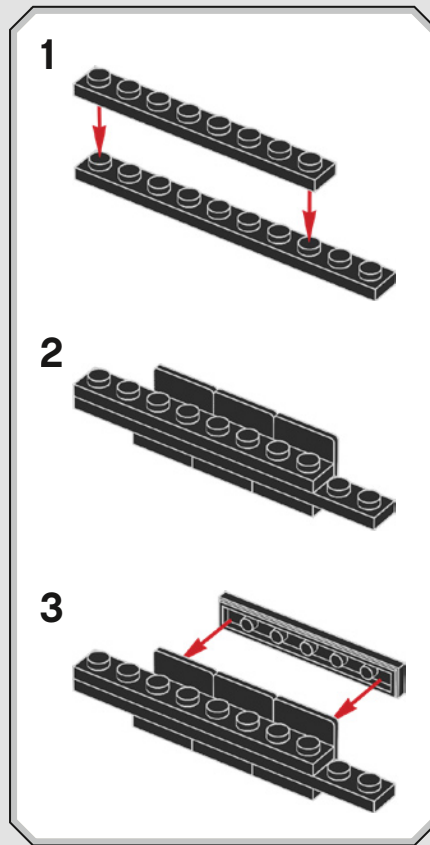

544

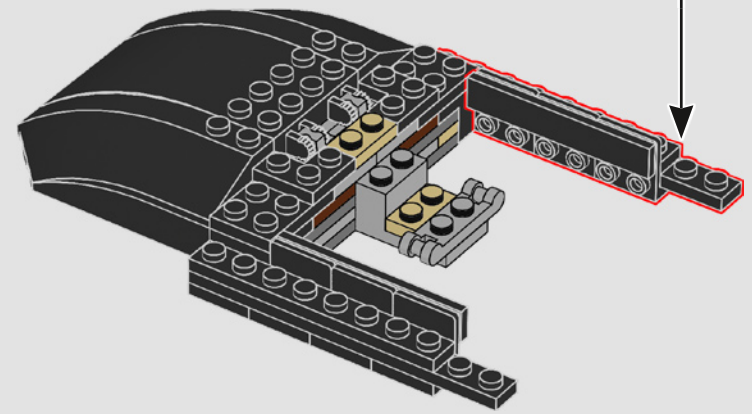
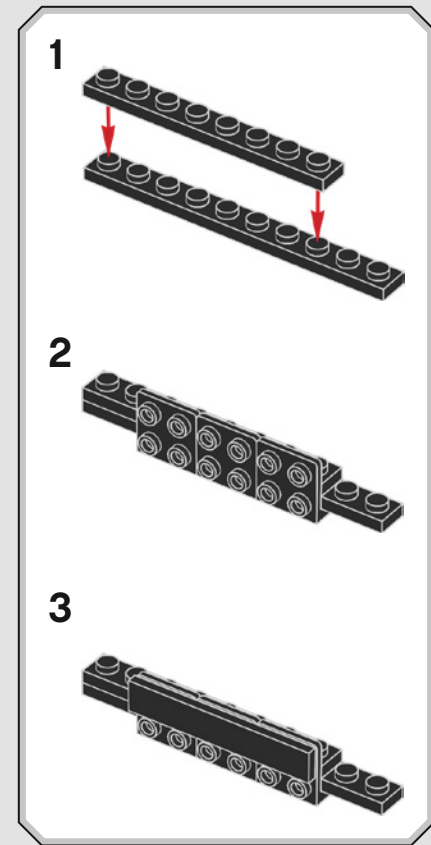

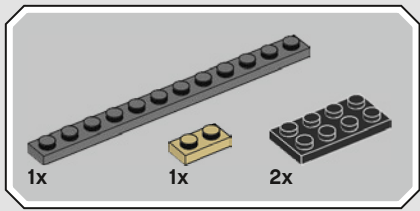

545

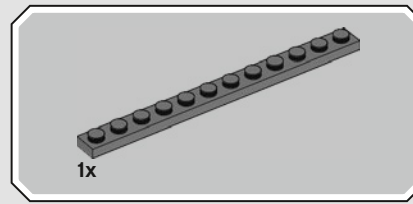
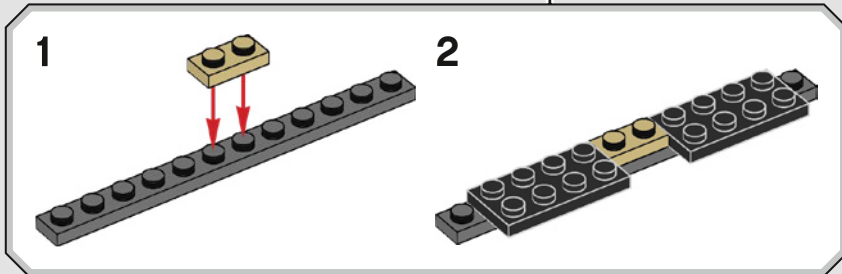
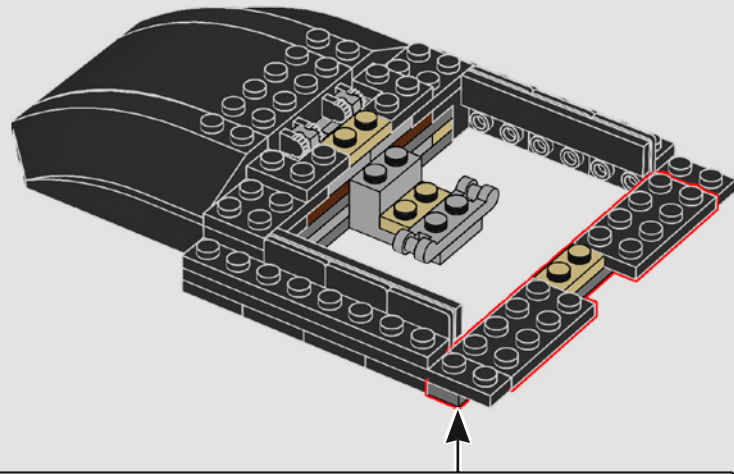

546

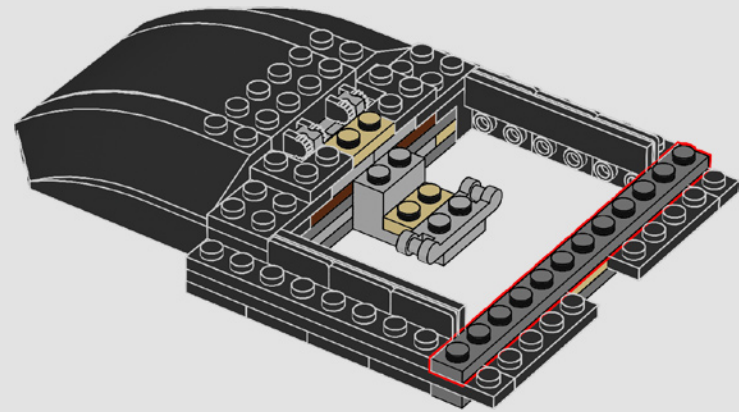

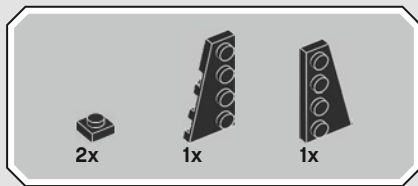

547

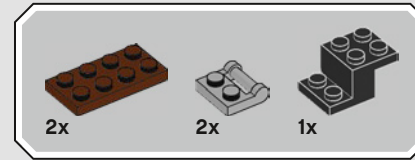
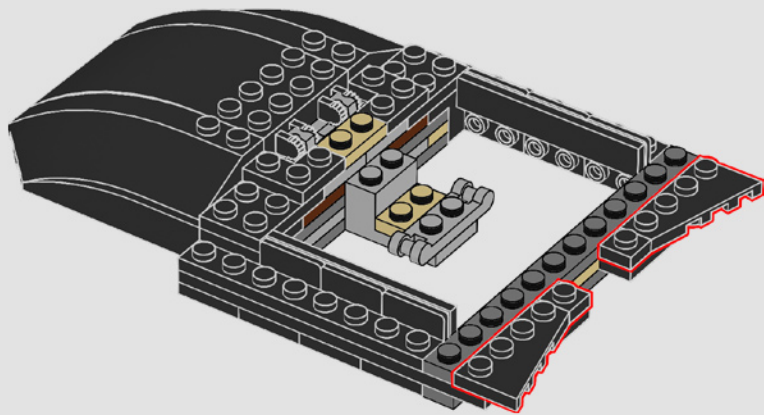

548

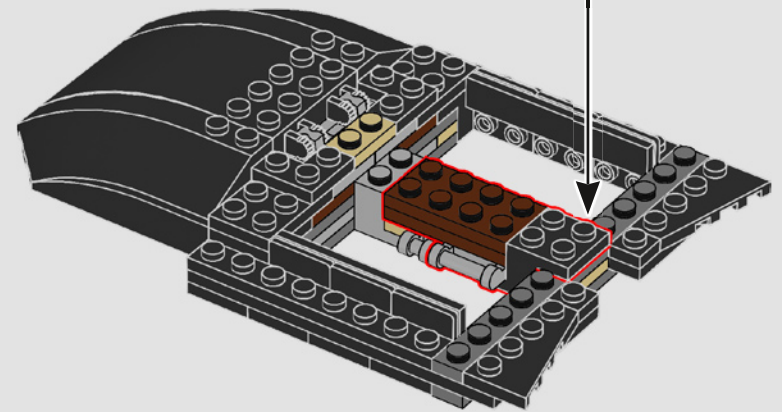
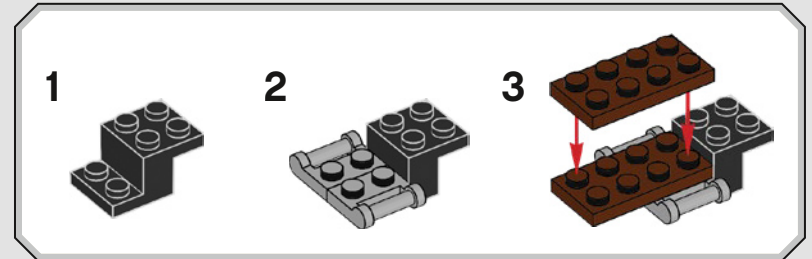

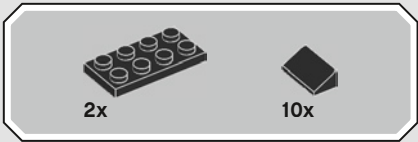

549

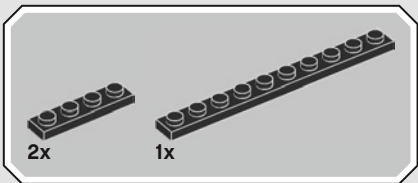
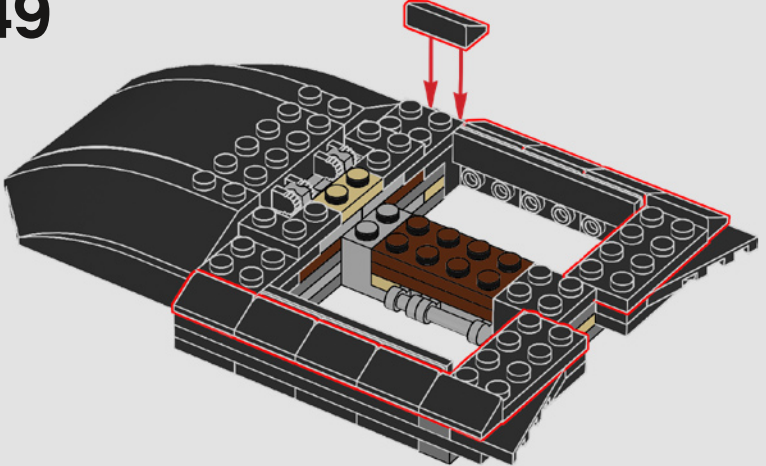

550

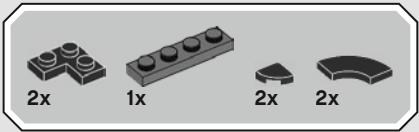
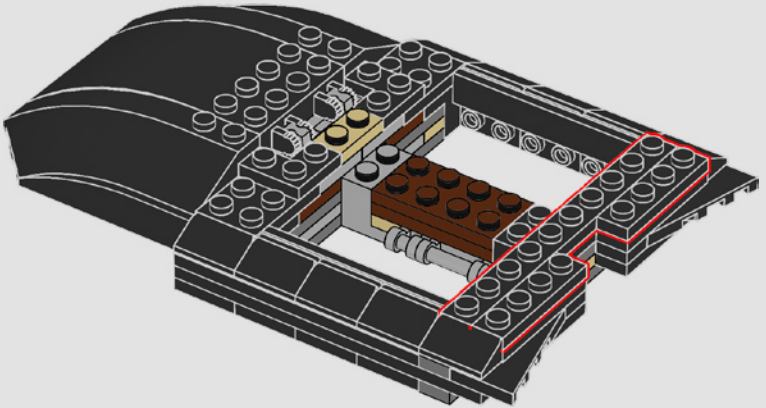

551

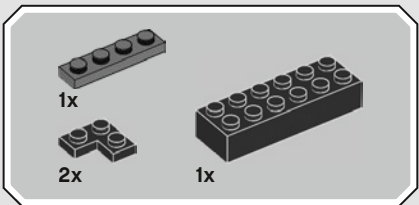
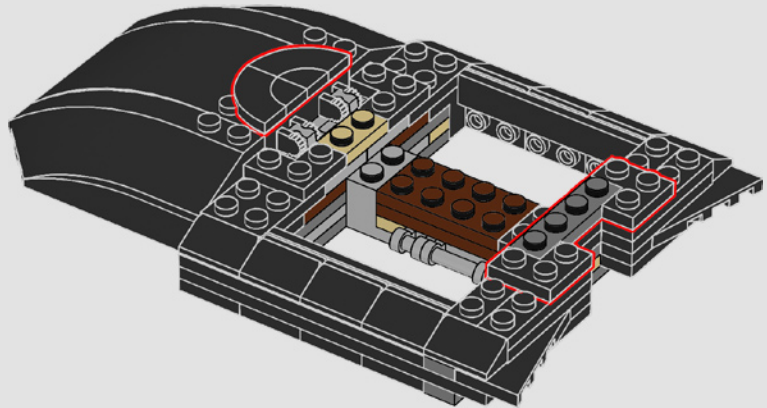

552

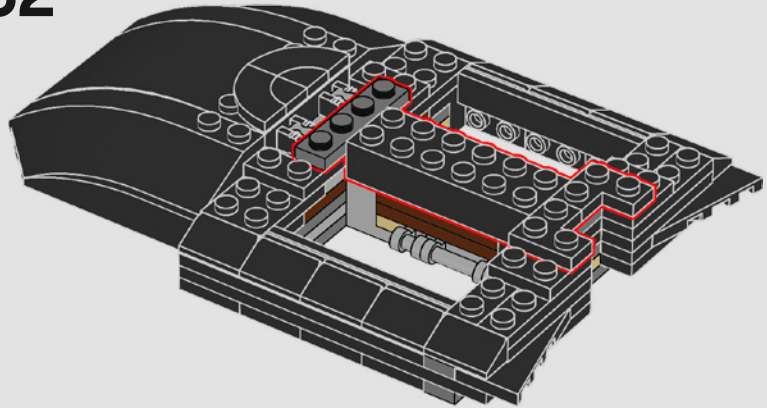



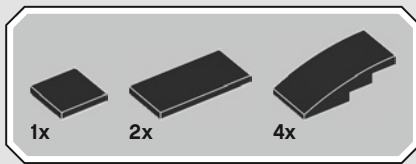

553

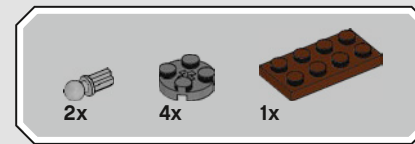
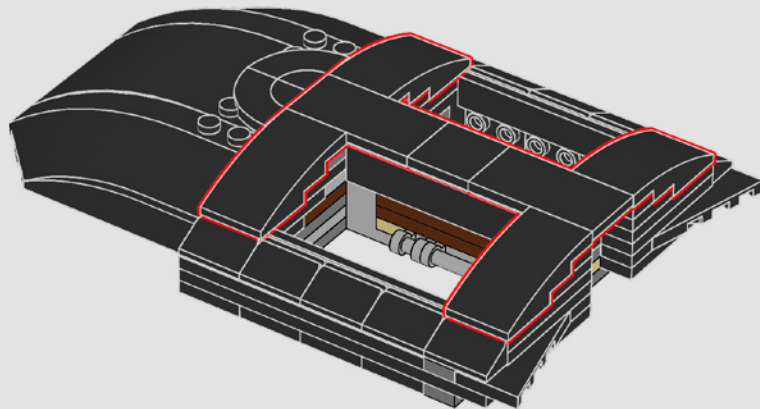

554

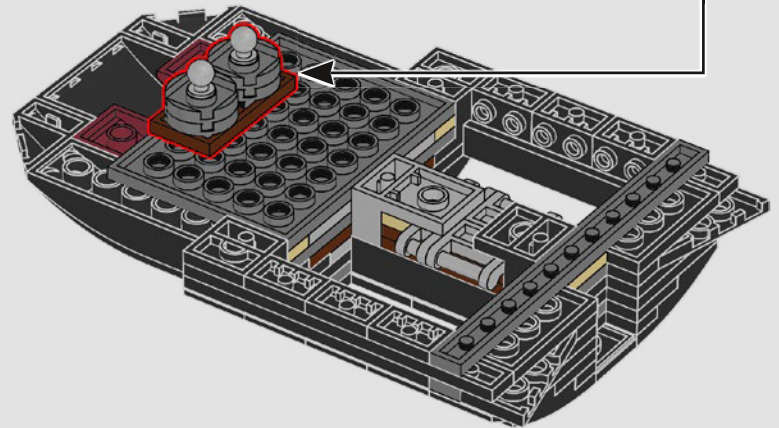
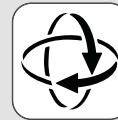
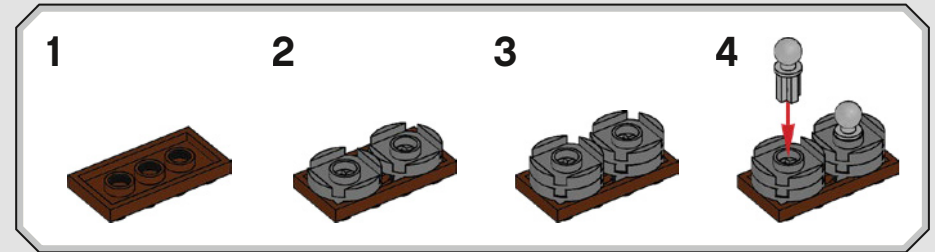

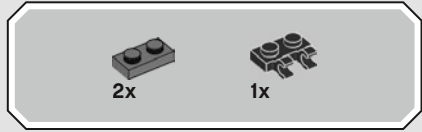
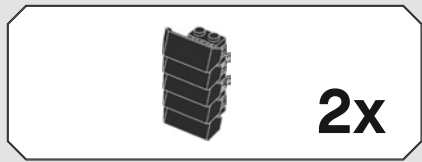

555

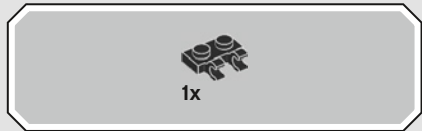
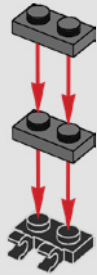

556

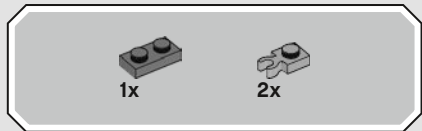
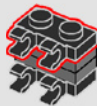

557

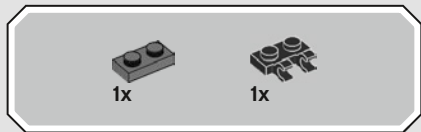
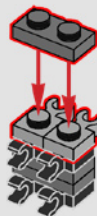

558

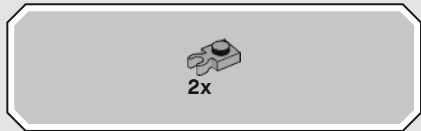
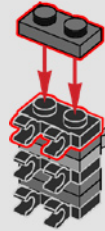

559

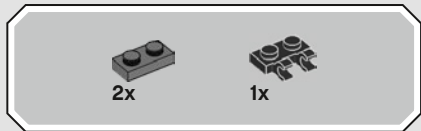
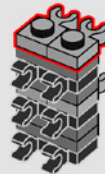

560

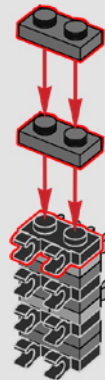



**561**

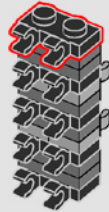

**562**

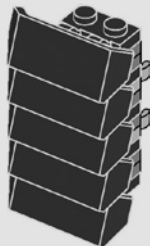

**2x**

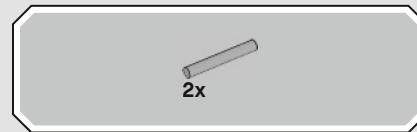

**563**

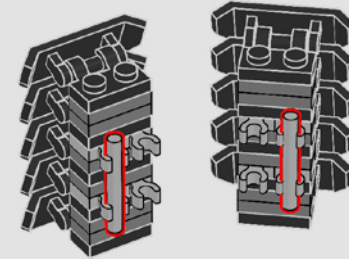

**564**

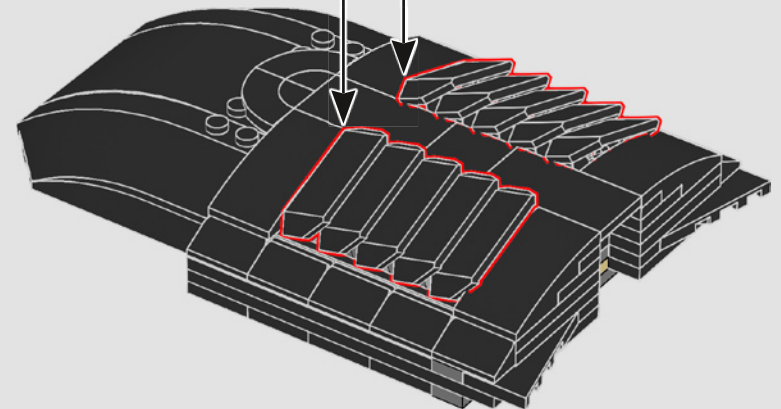
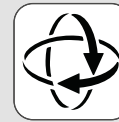

565

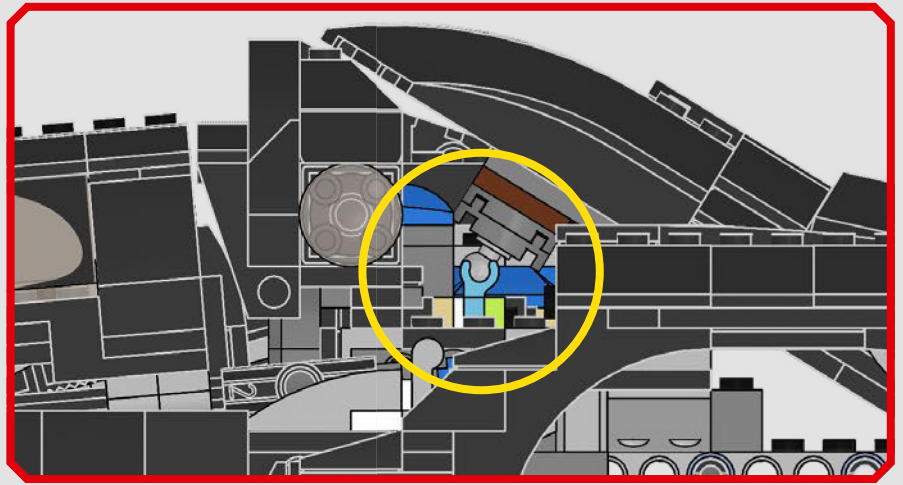
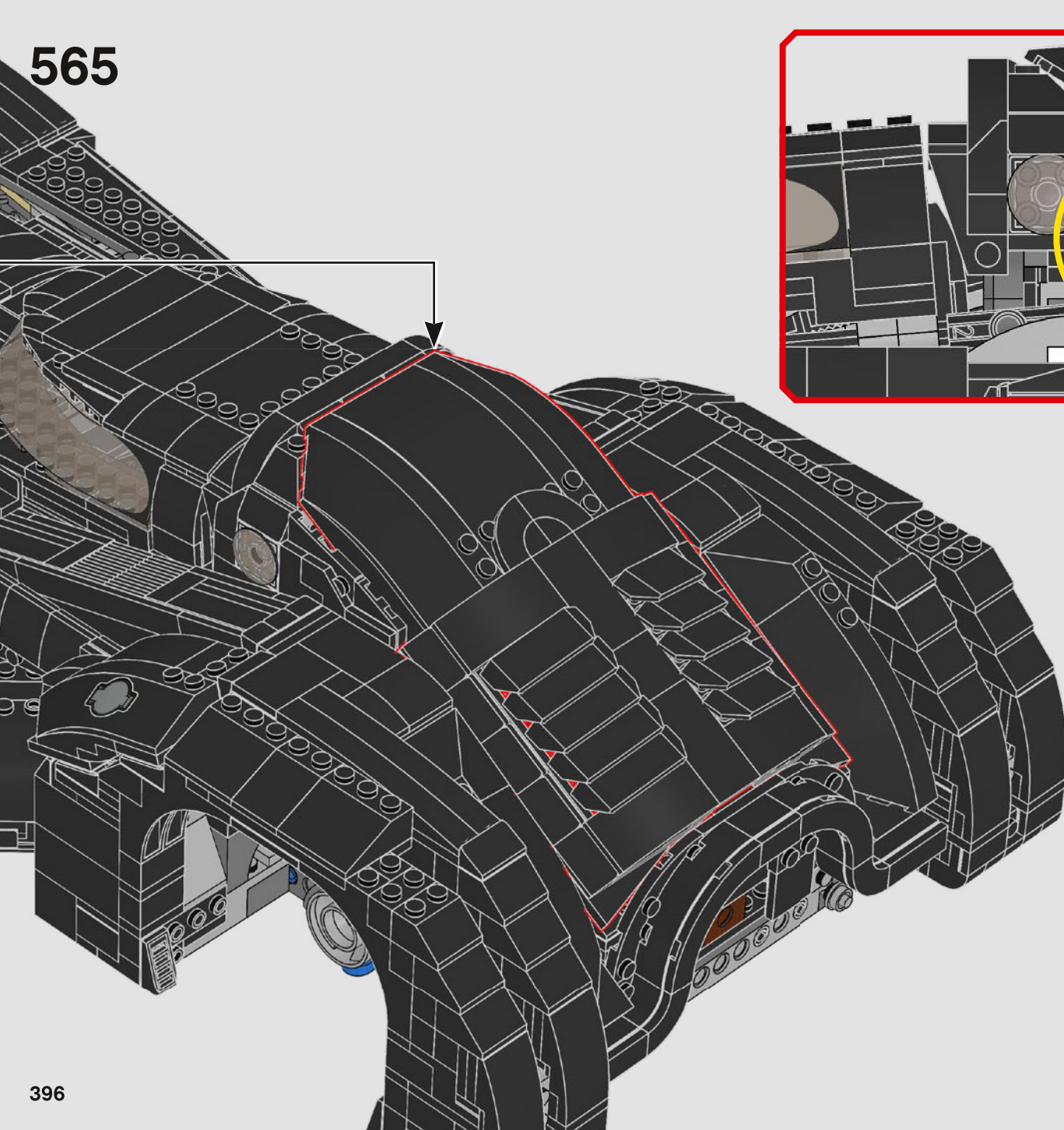

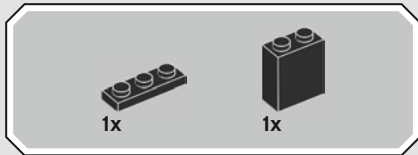
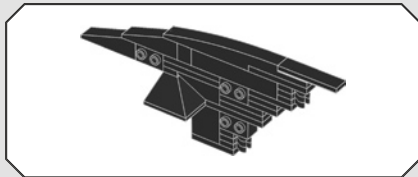
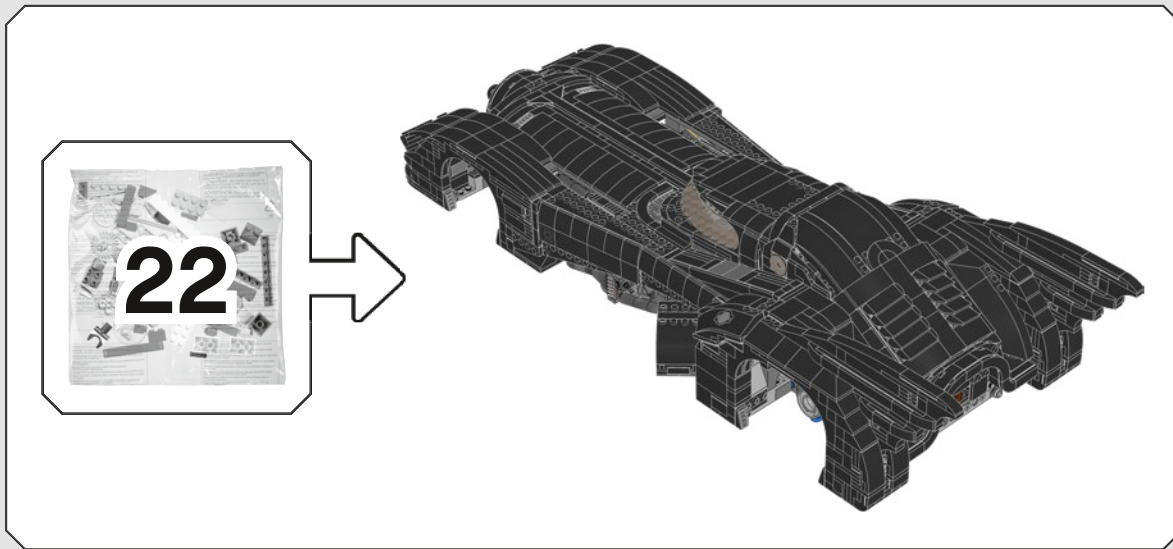

566

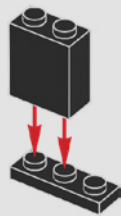

567

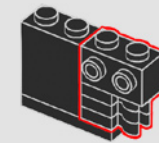
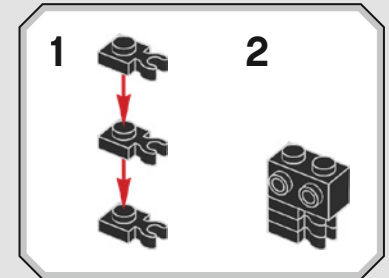

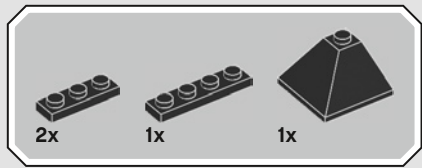

568

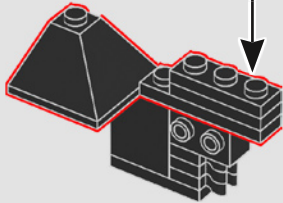
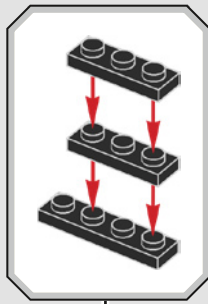

569

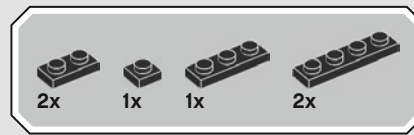
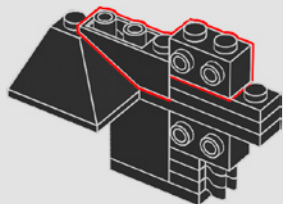

570

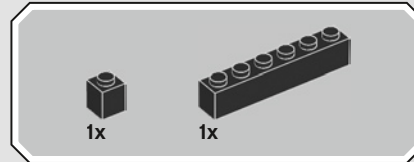
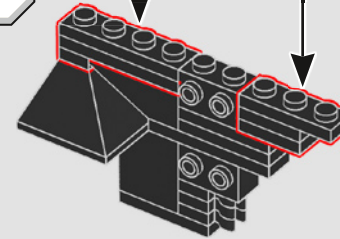
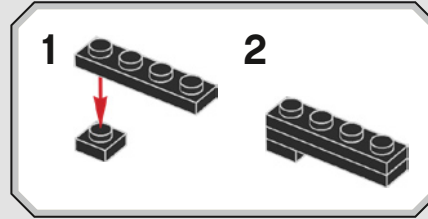
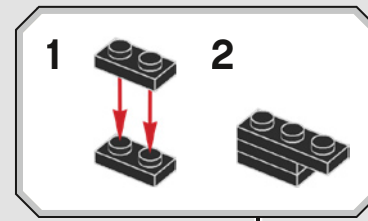

571

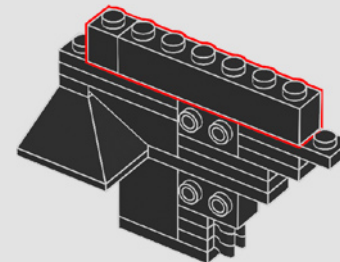

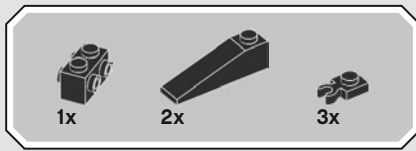

572

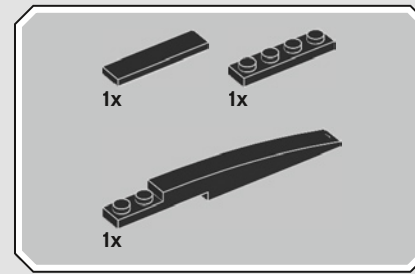
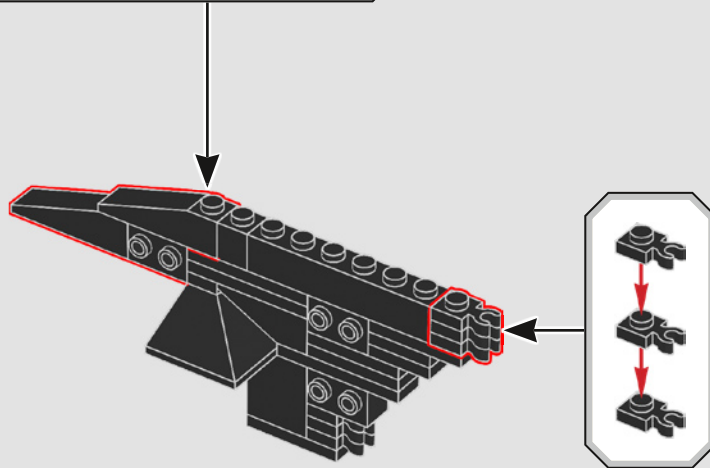
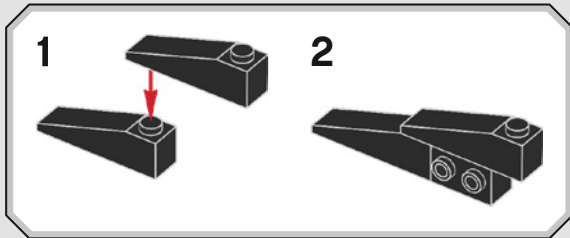

573

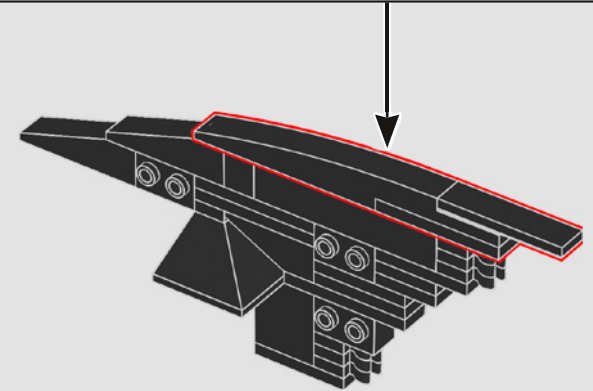
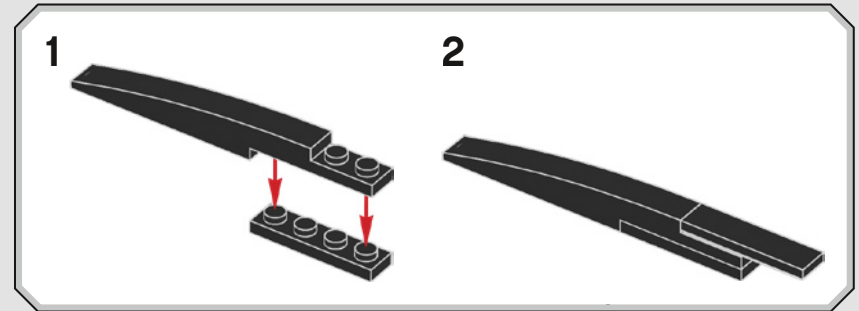

574

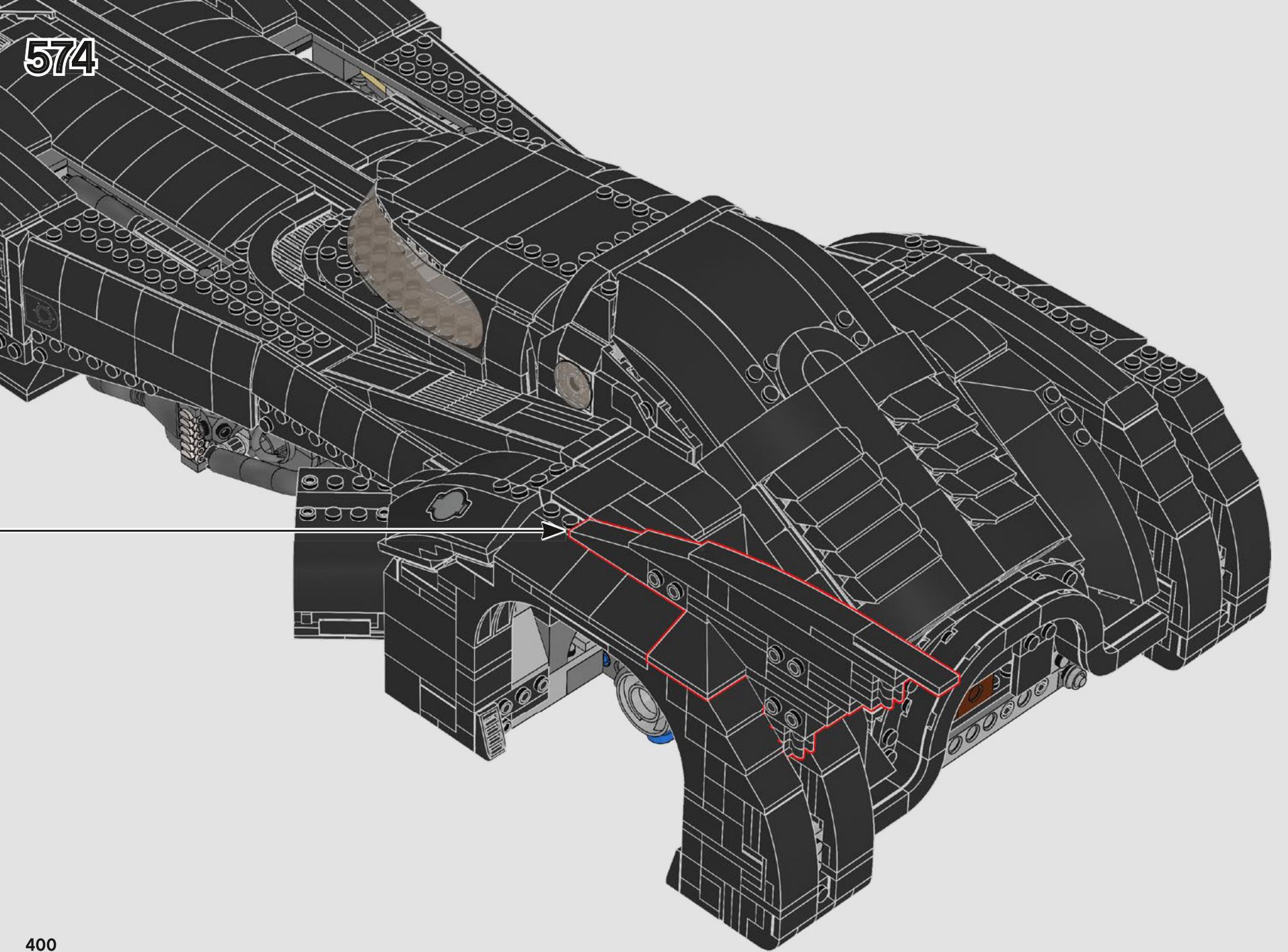



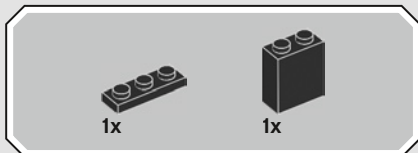
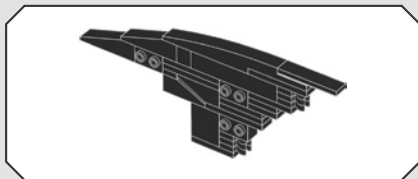

575

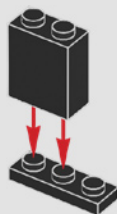

576

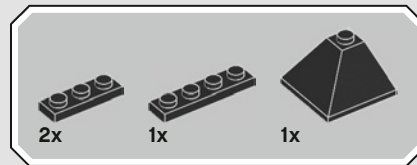
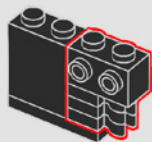
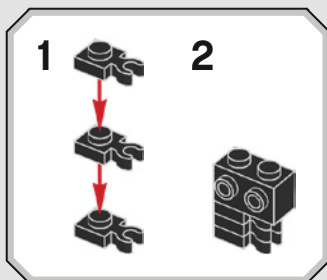

577

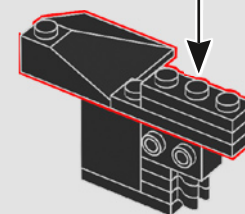
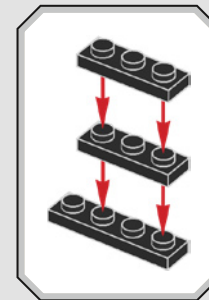

578

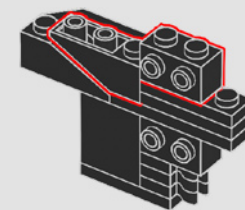

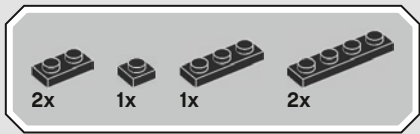

579

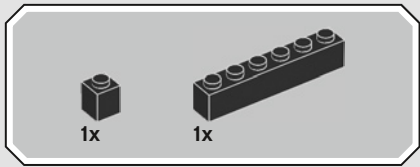
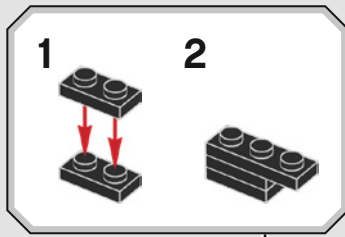
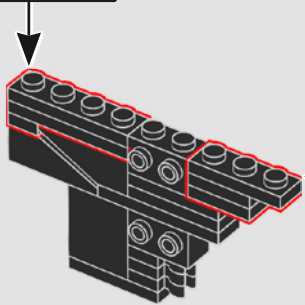
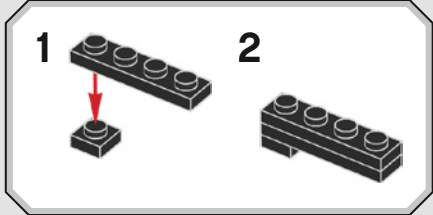

580

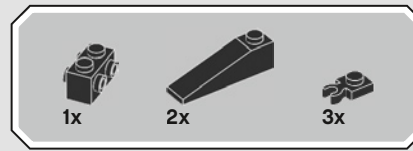
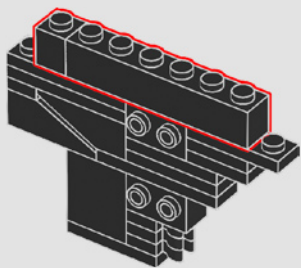

581

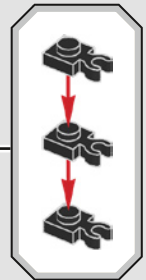
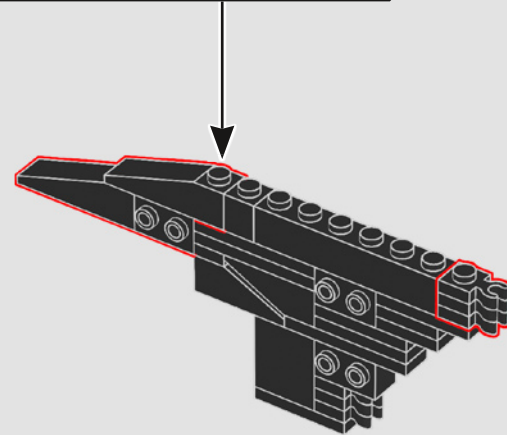
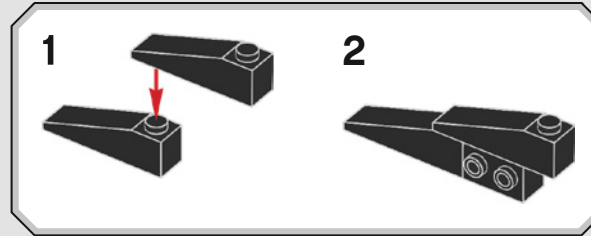

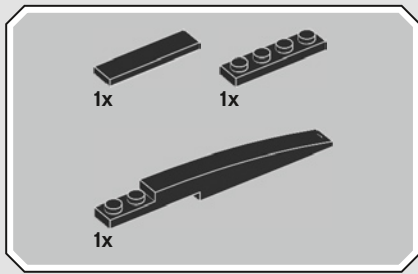

582

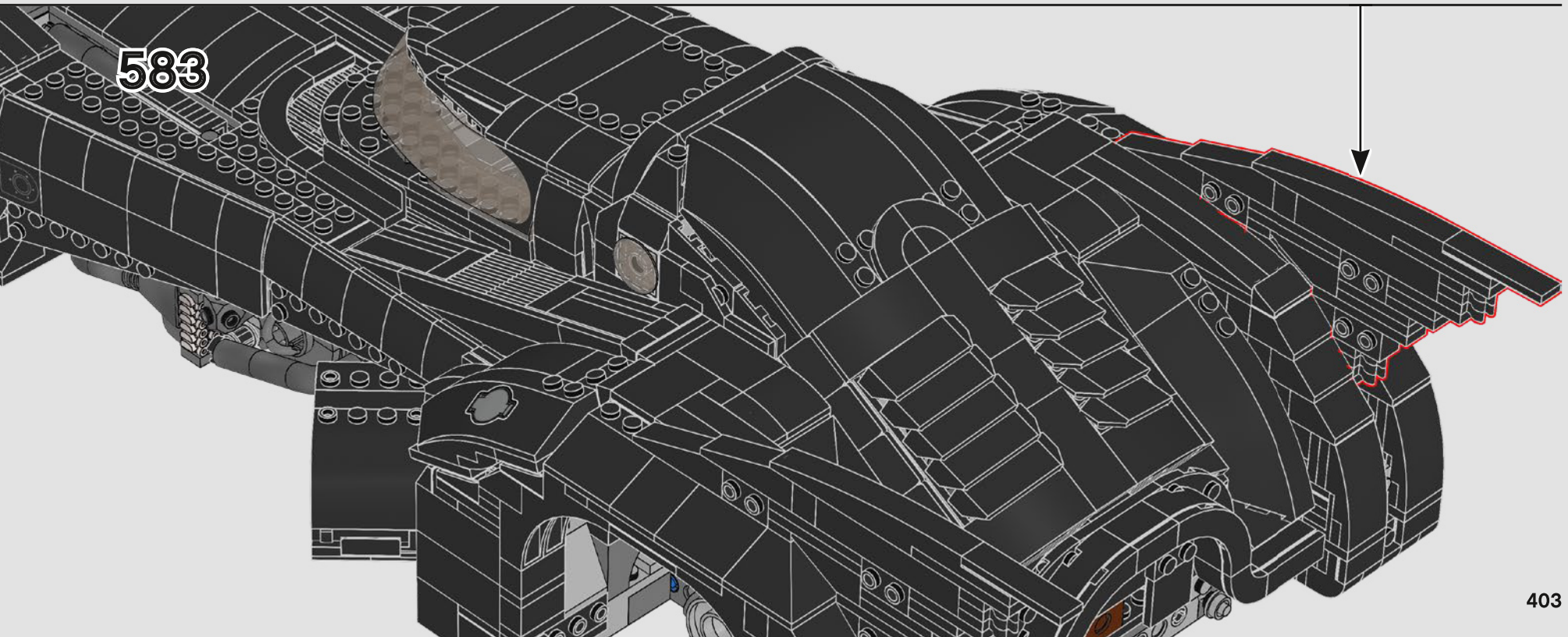
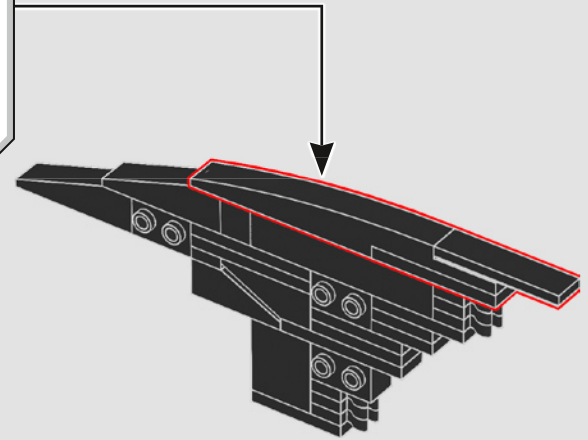
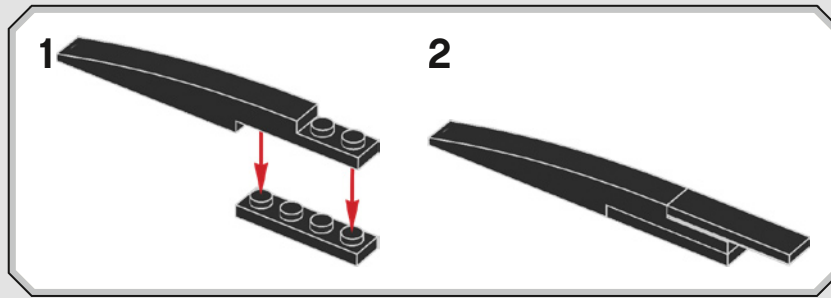

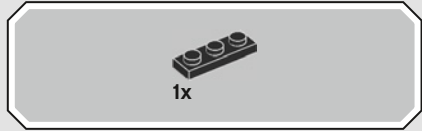
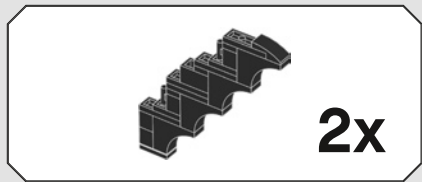

584

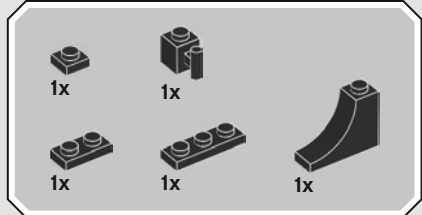
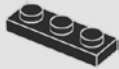

585

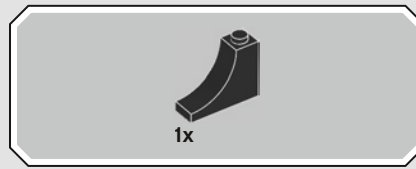
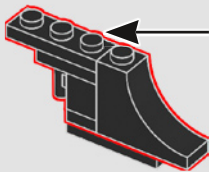
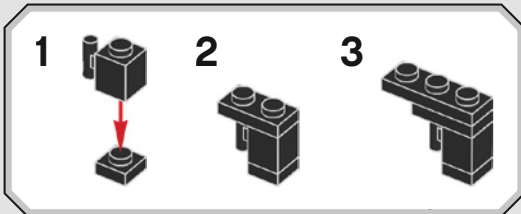

586

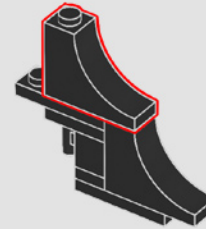

587

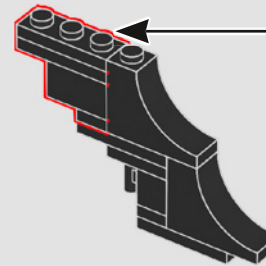
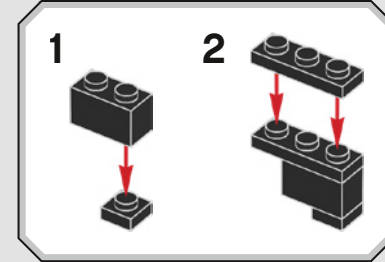

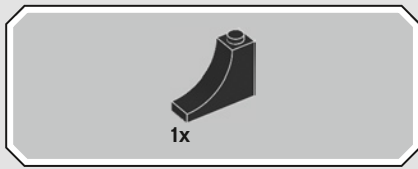

588

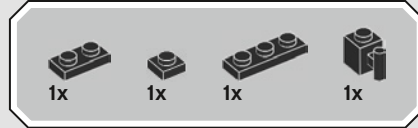
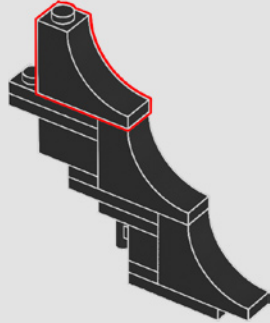

589

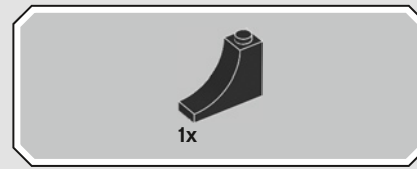
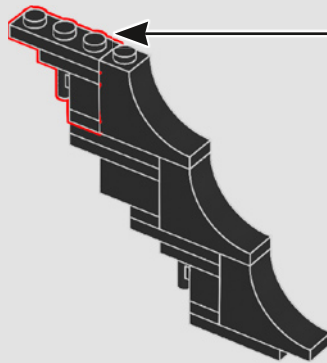
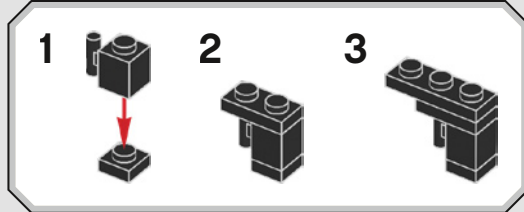

590

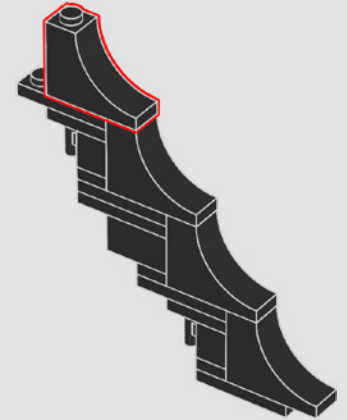

591

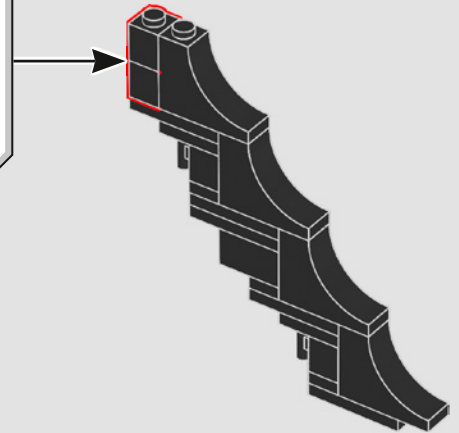
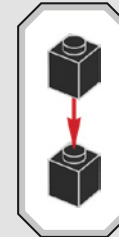

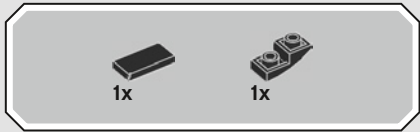

592

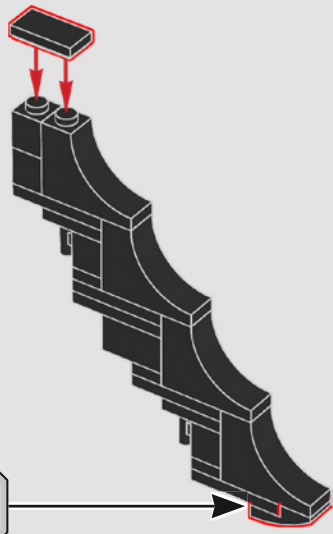

593

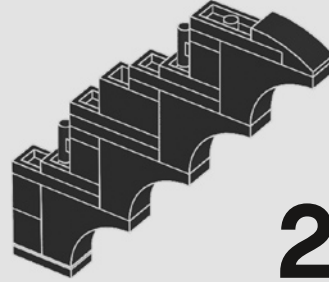

2x

594

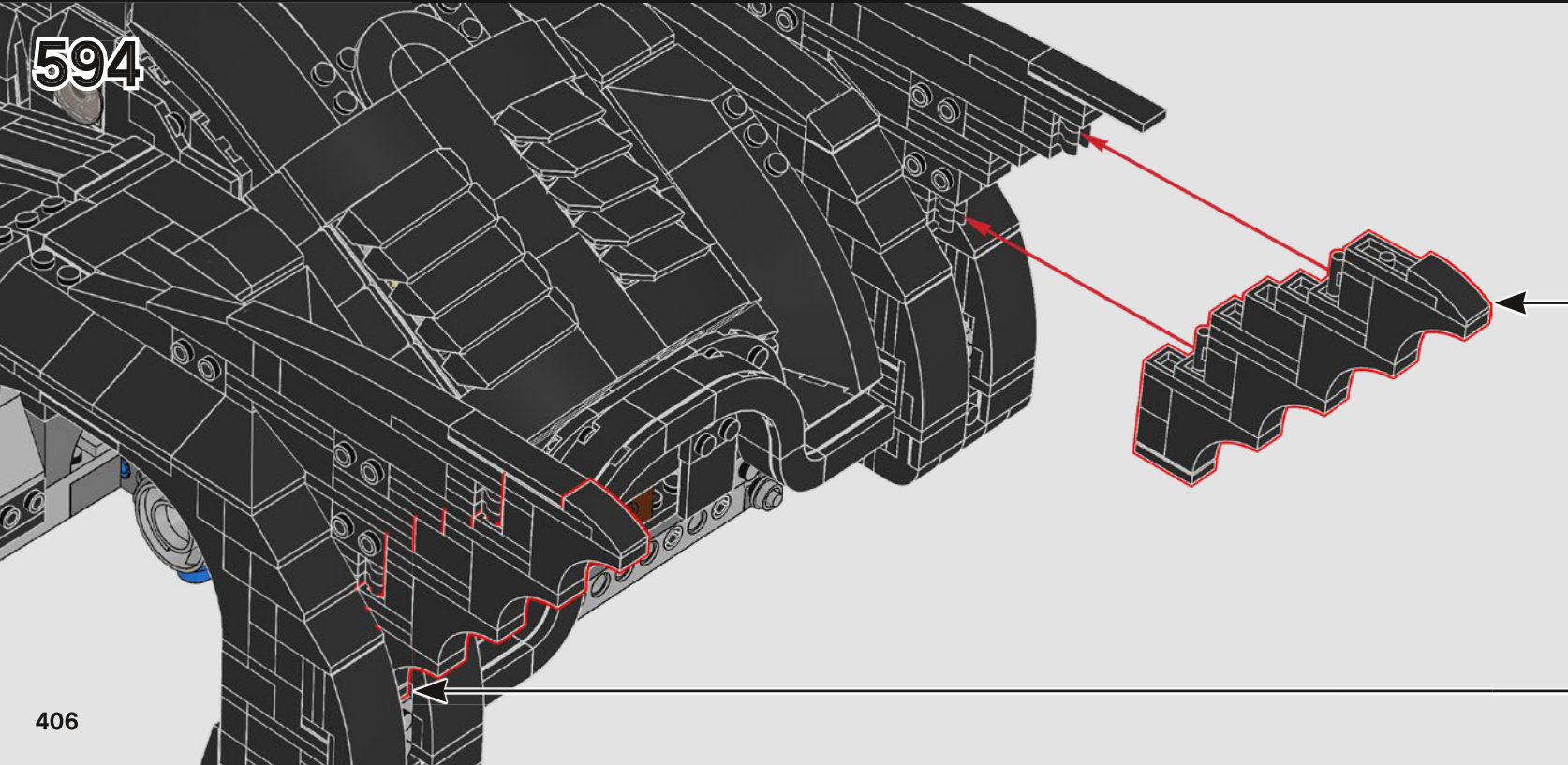

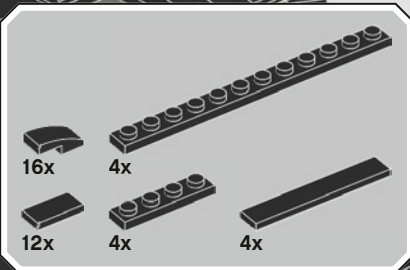

595

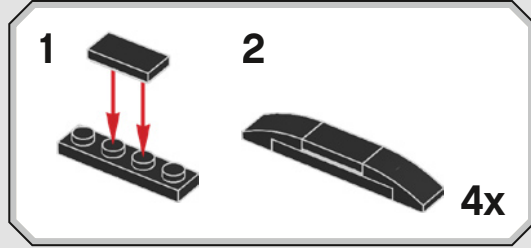
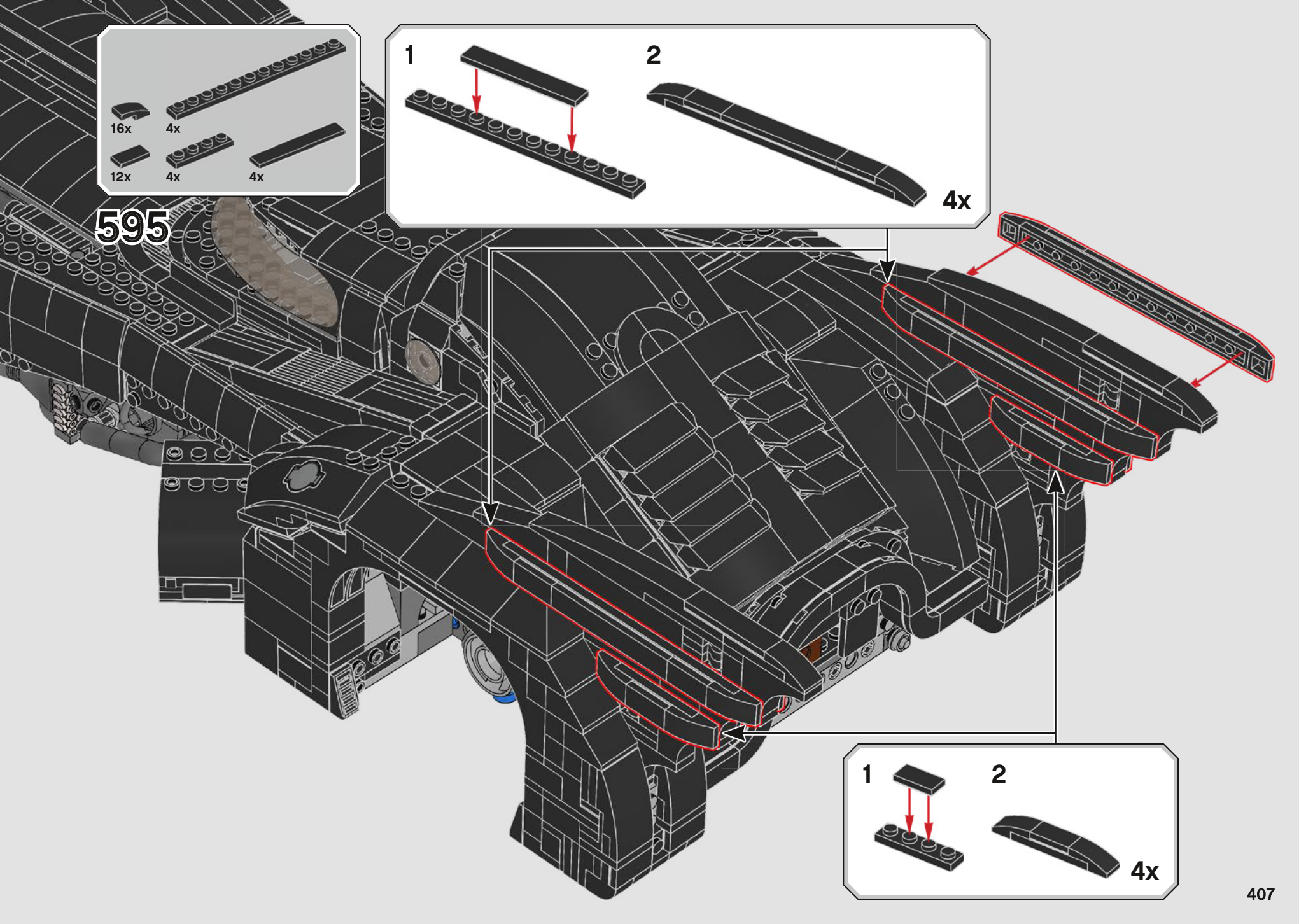
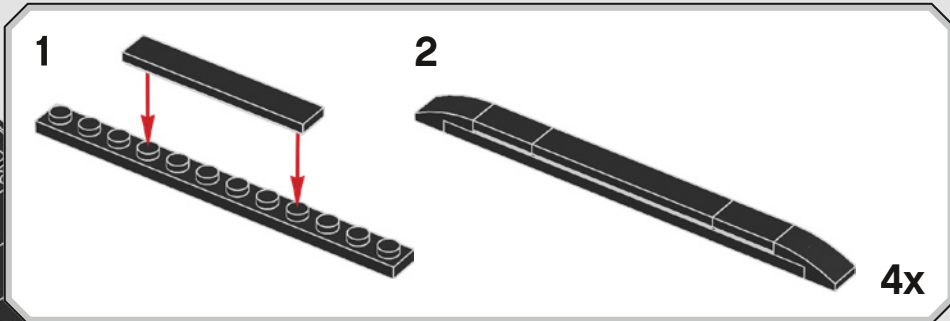

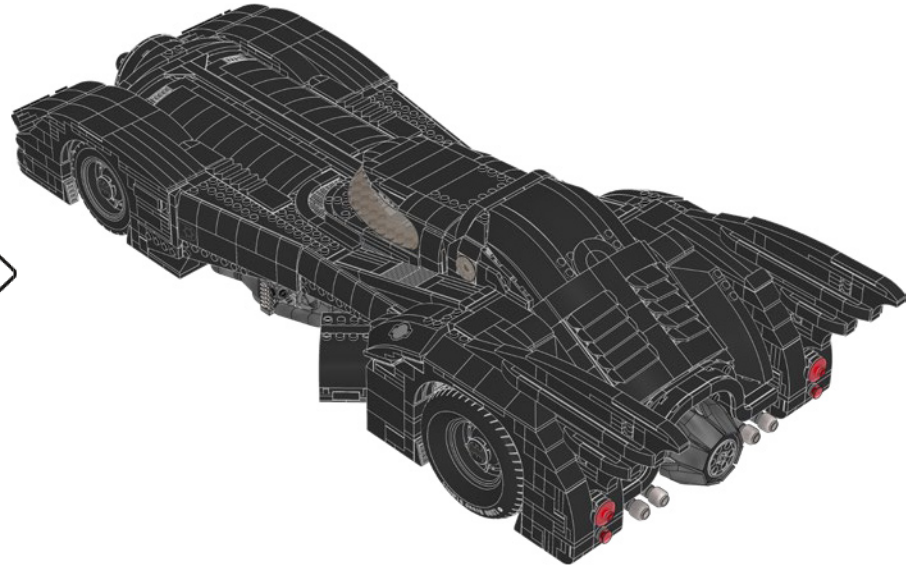
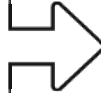
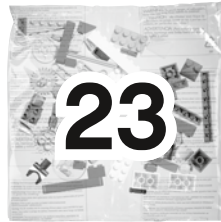



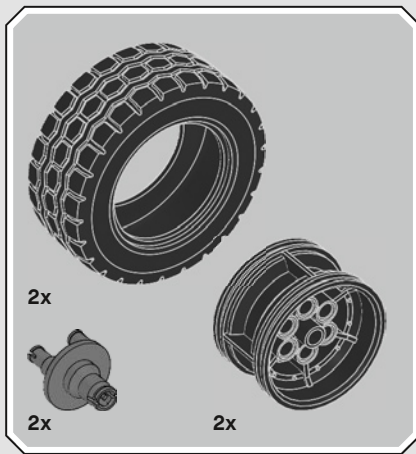

**596**

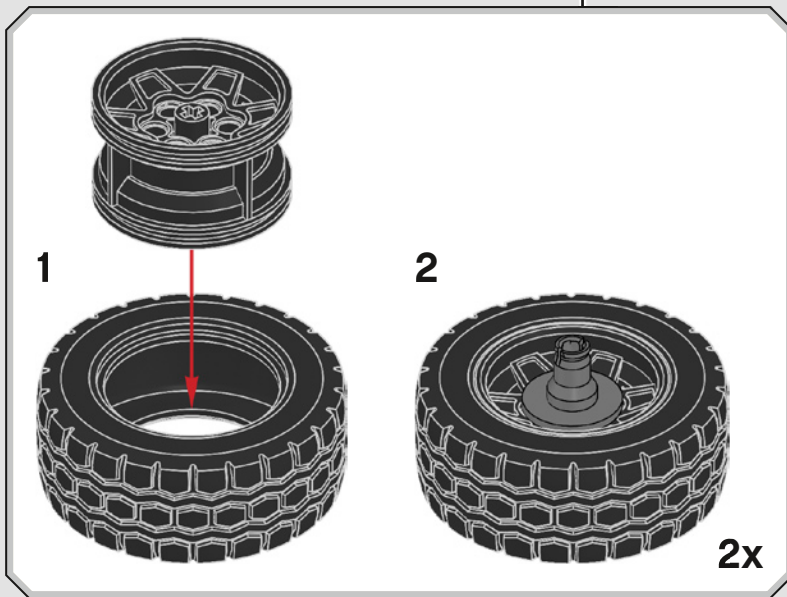
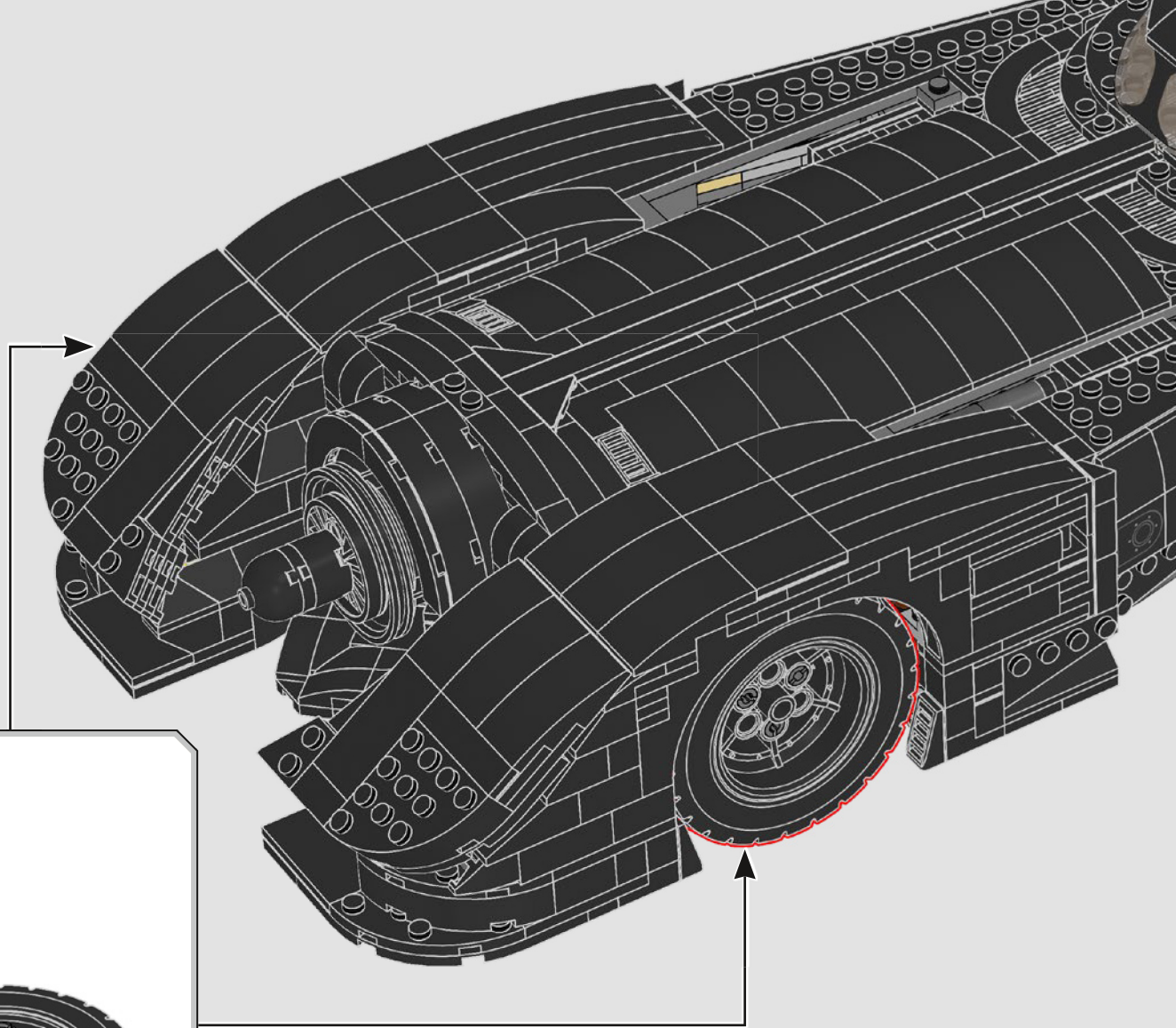

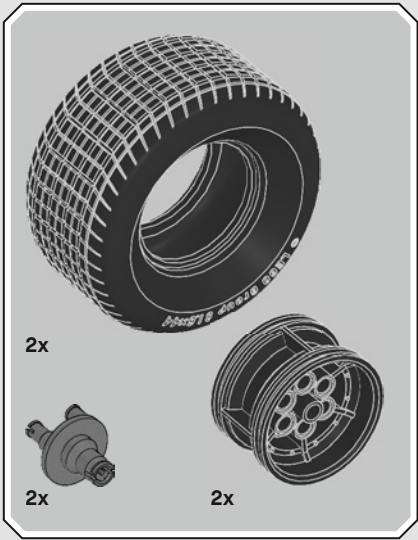

597

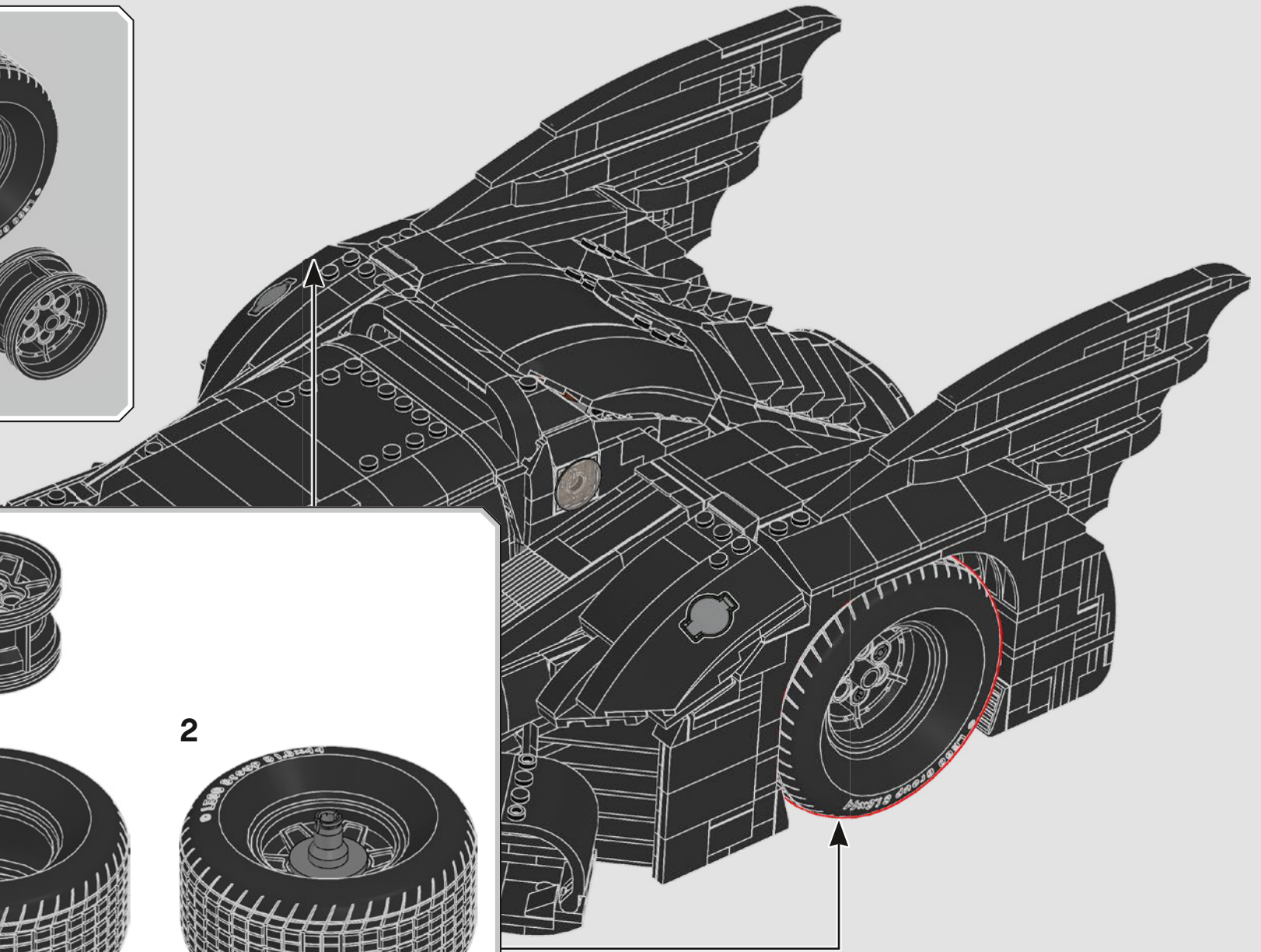
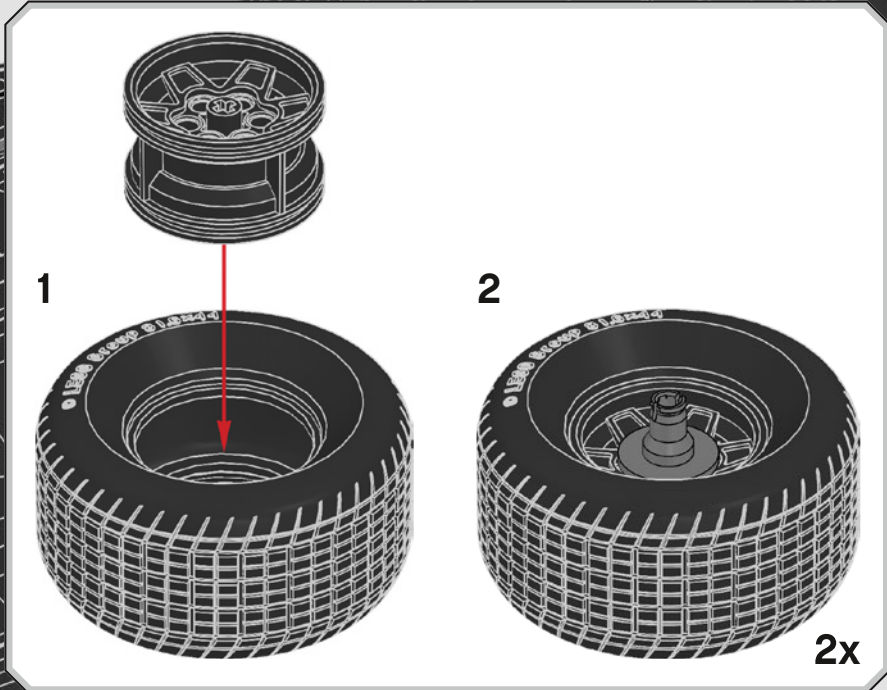

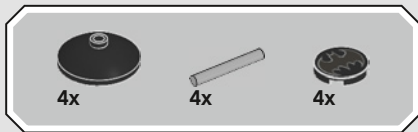

598

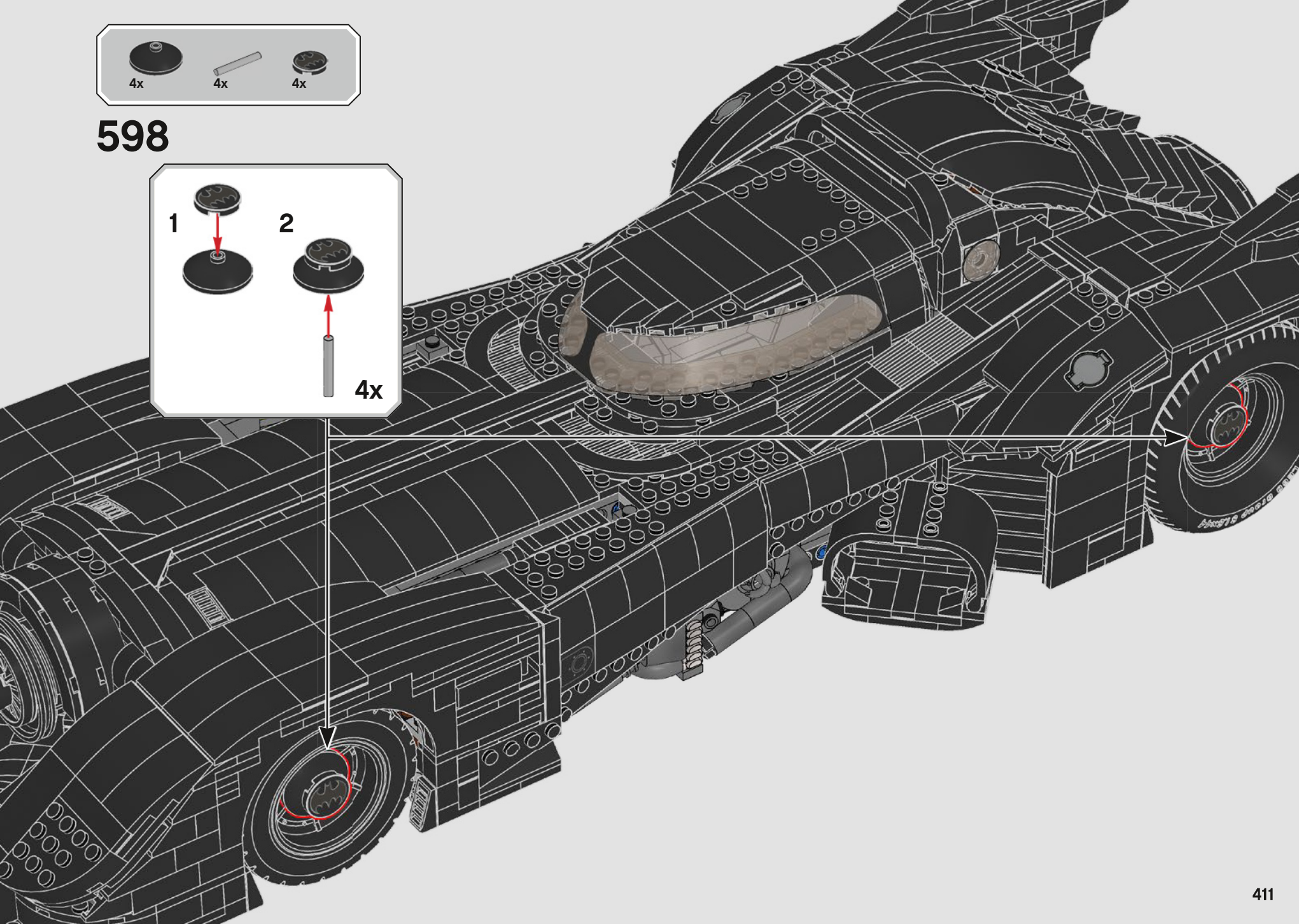
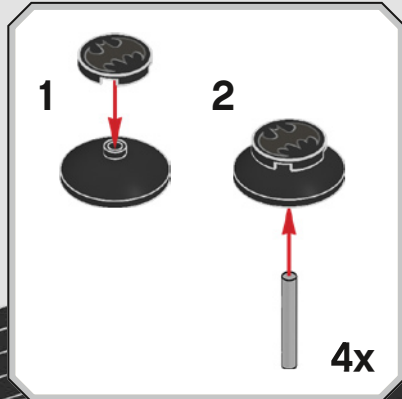

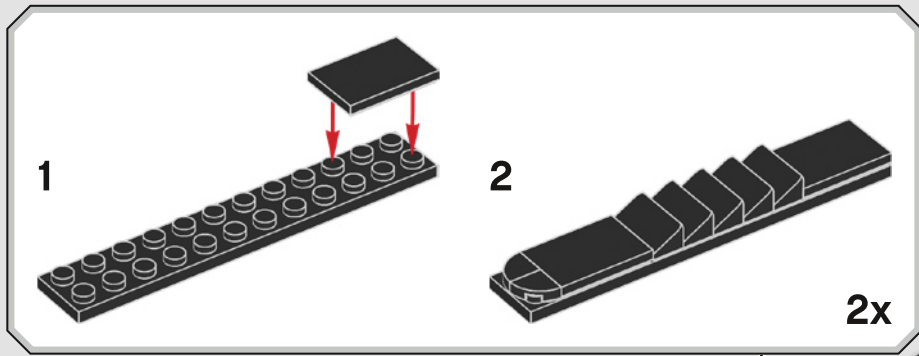
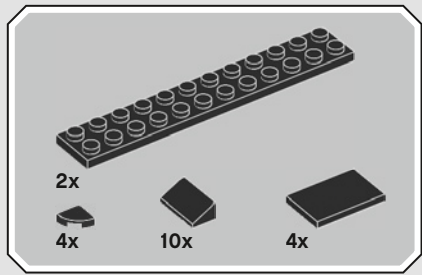

599

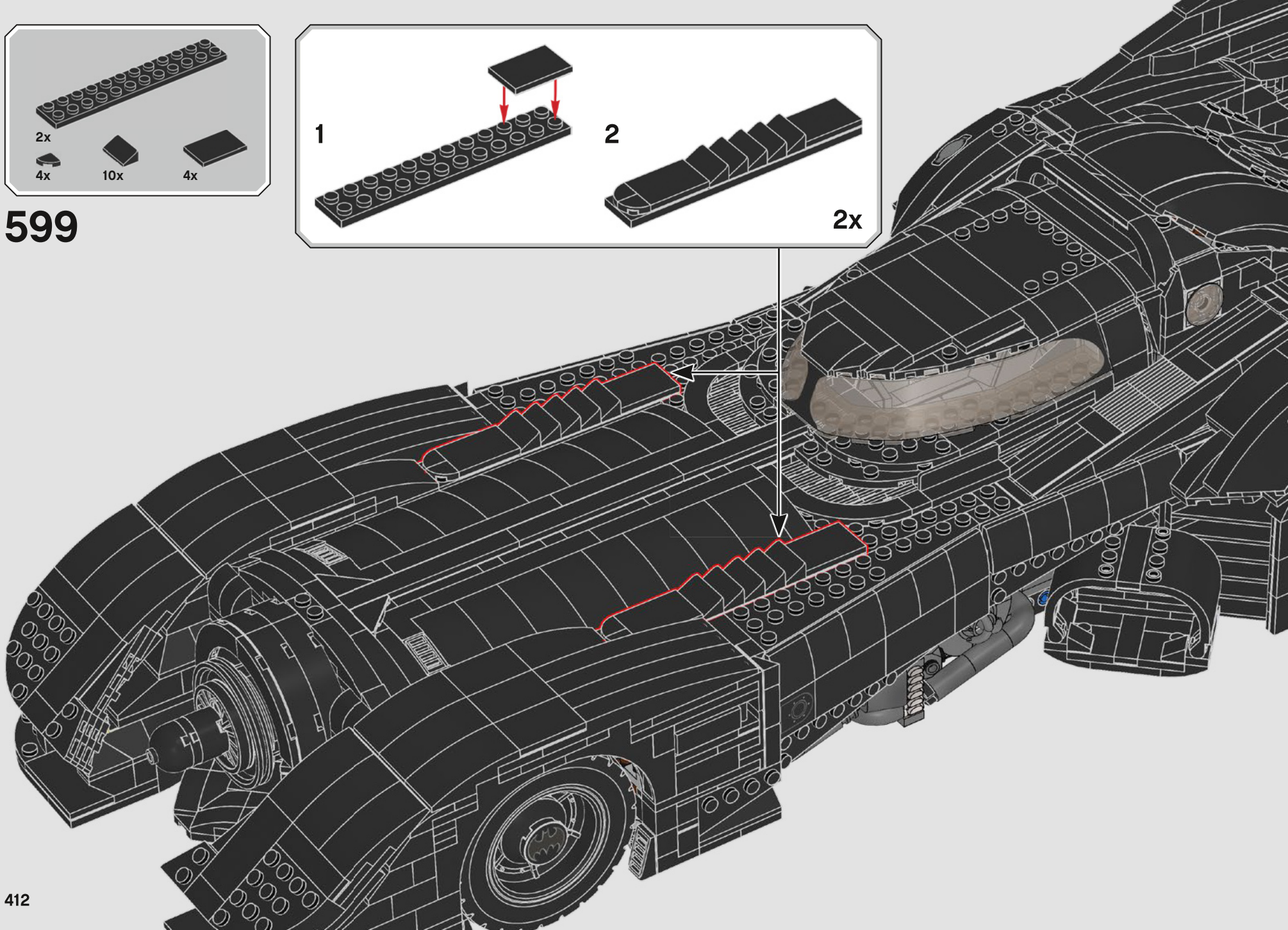

-  2x
-  2x
-  2x
-  2x
-  4x
-  2x

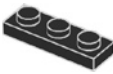
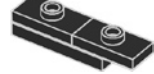
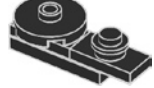
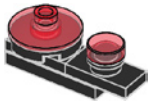
- 
- 
- 
-  2x

600

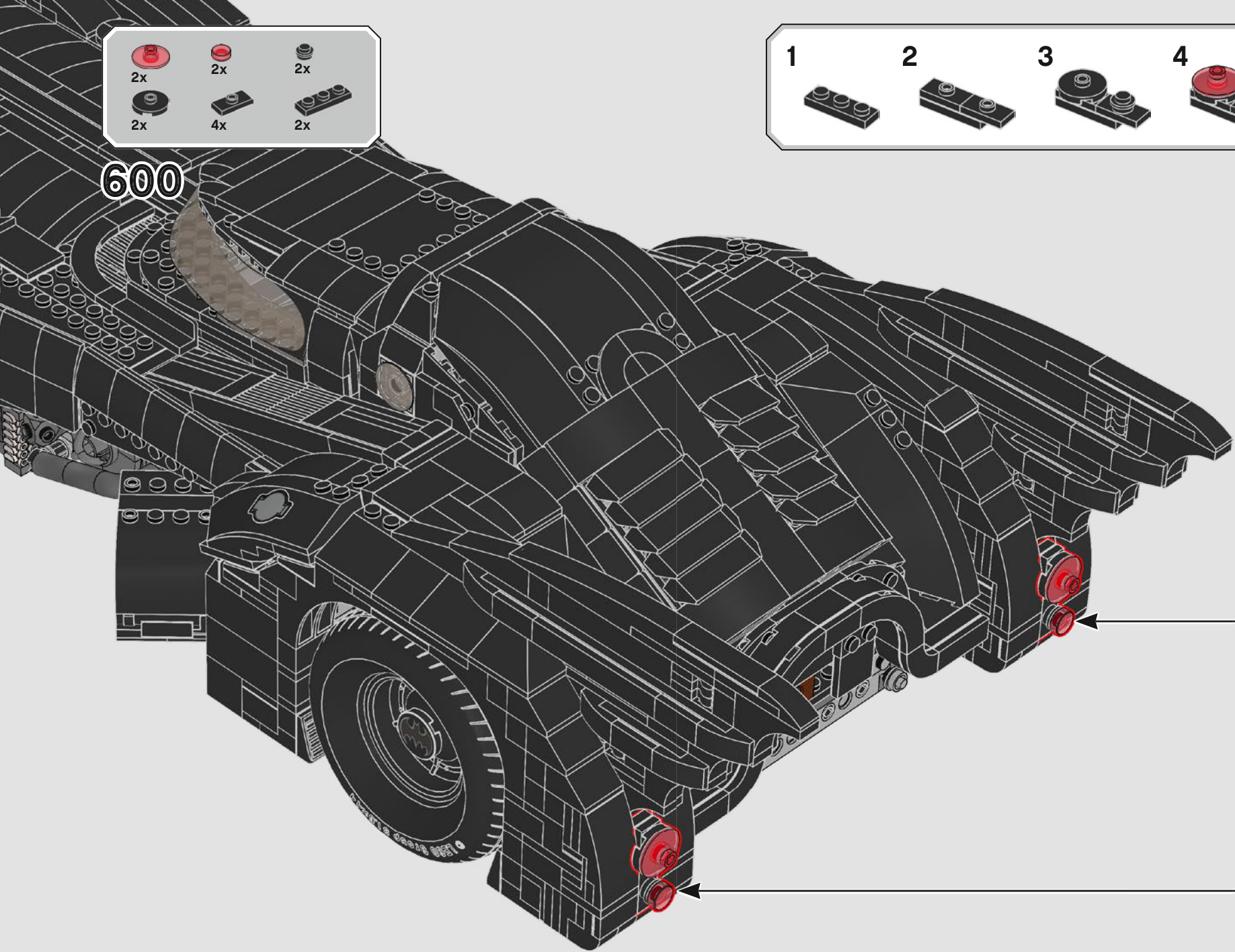

4x 4x 1x 4

4 1:1

601

4

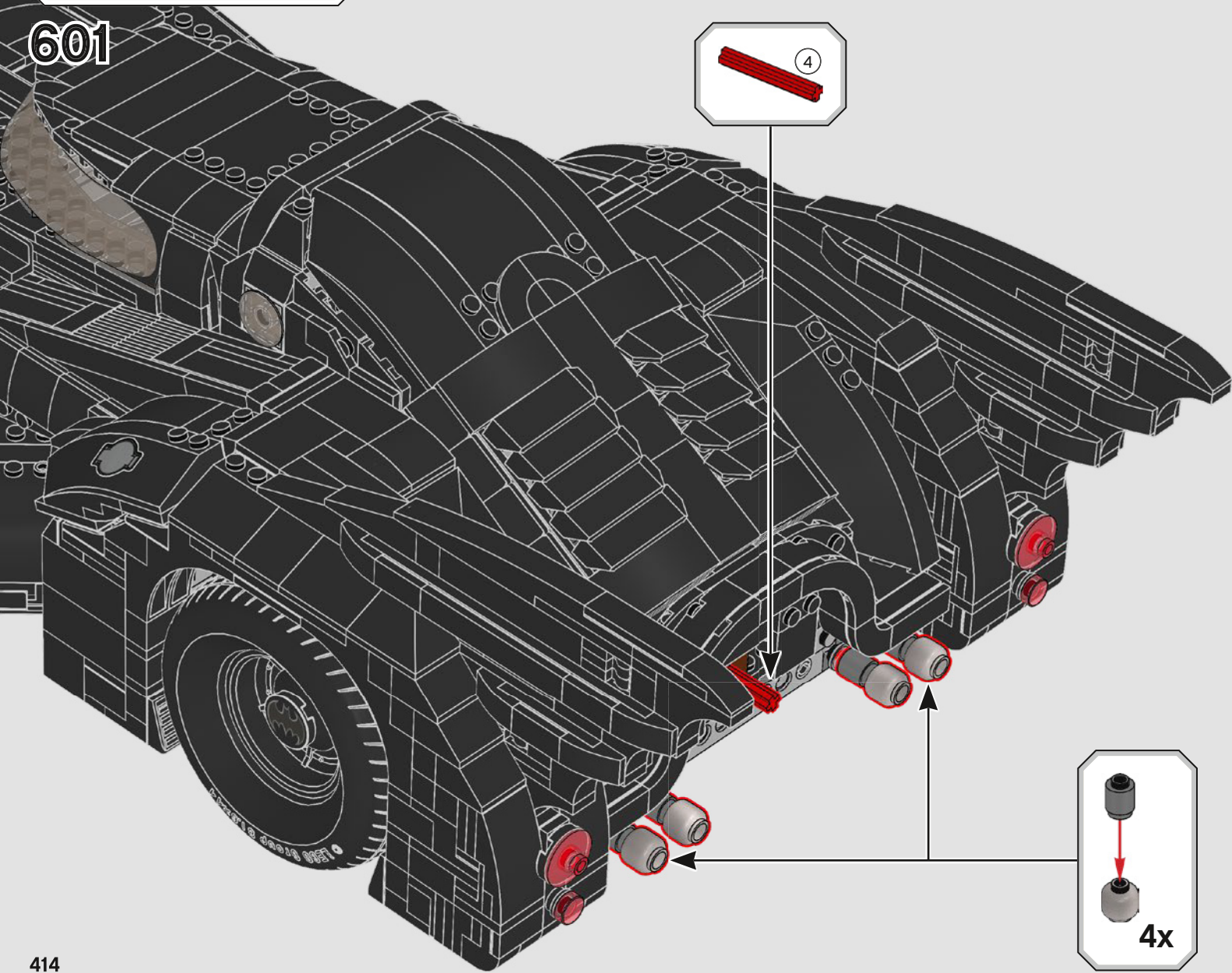

4x

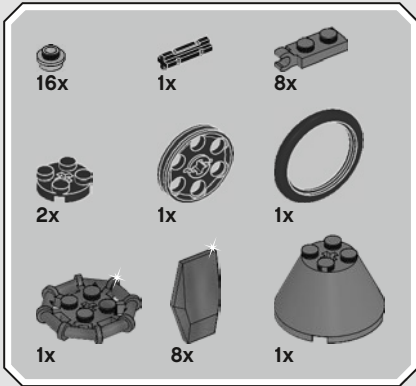

602

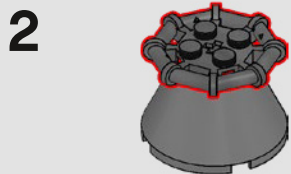
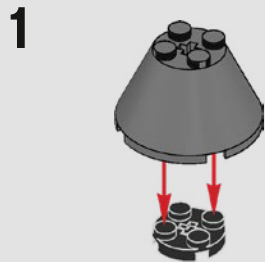

3

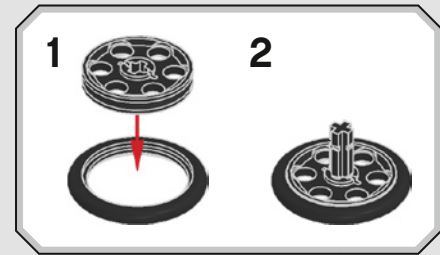
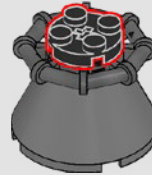

4

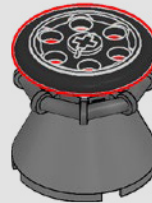

5

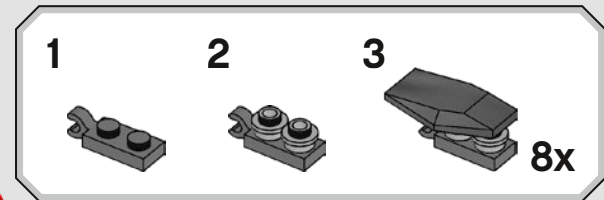
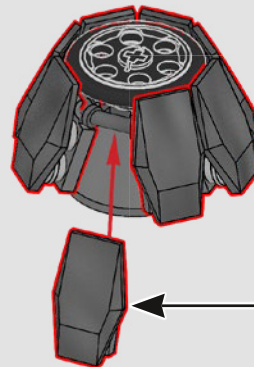

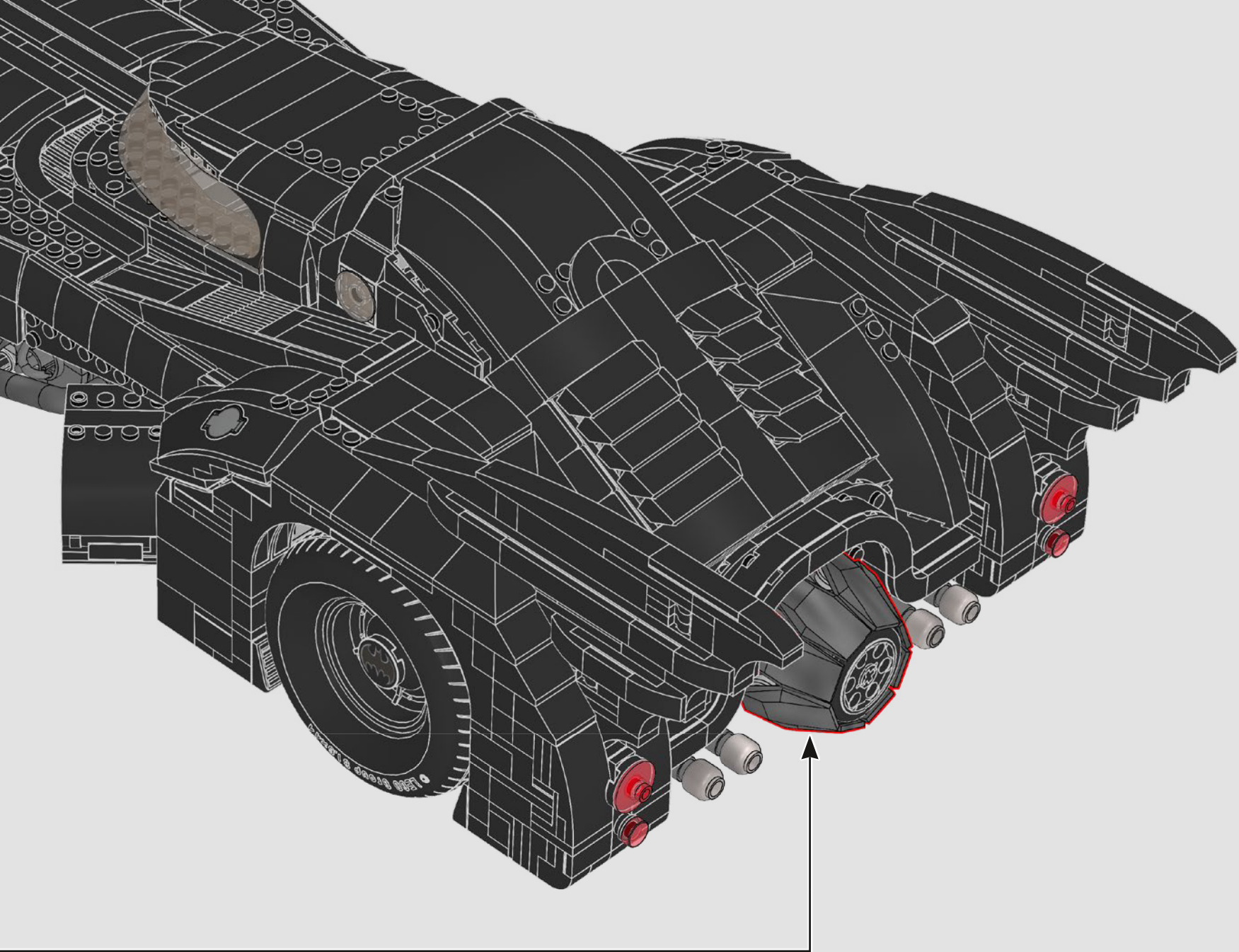



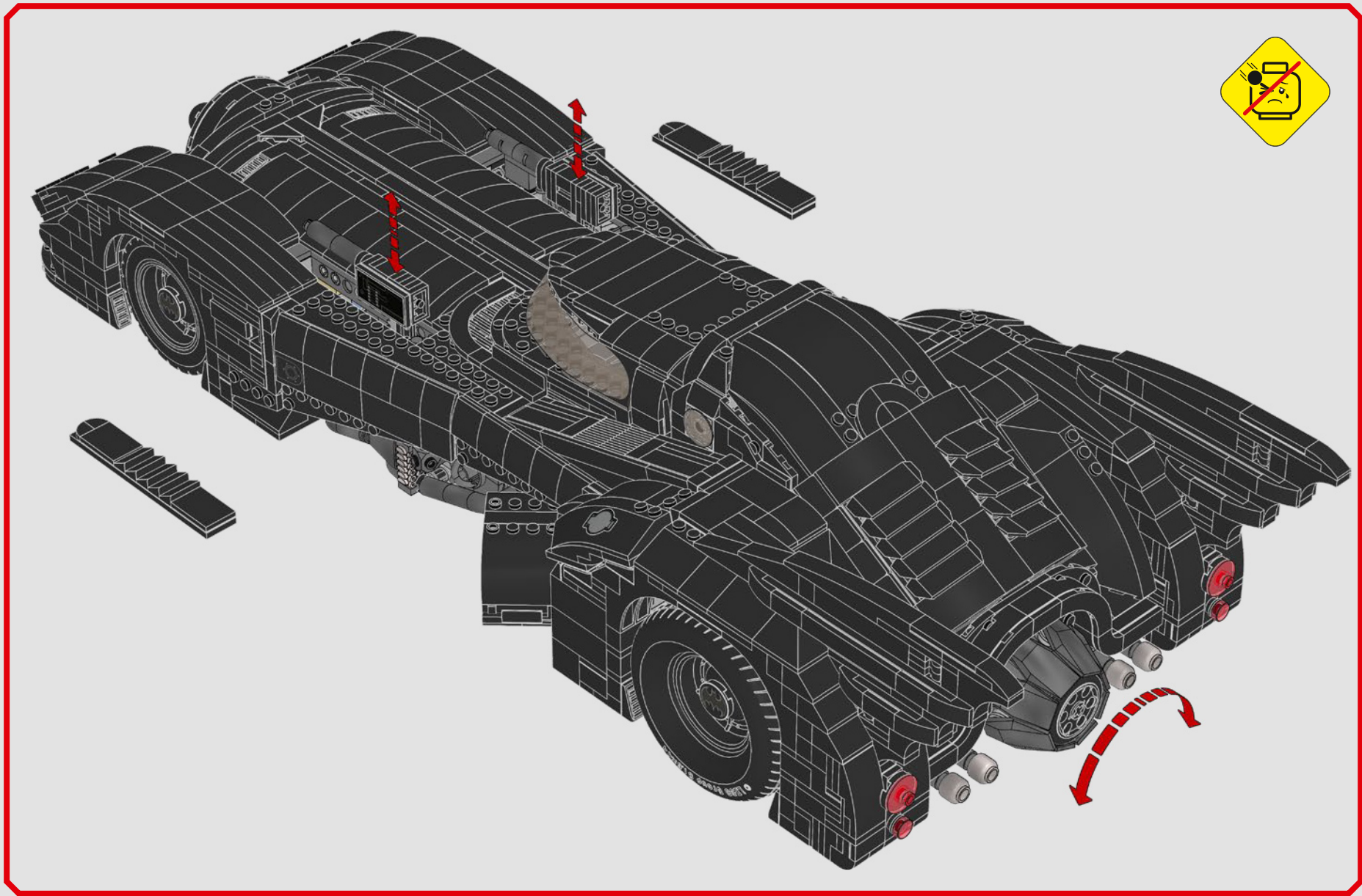

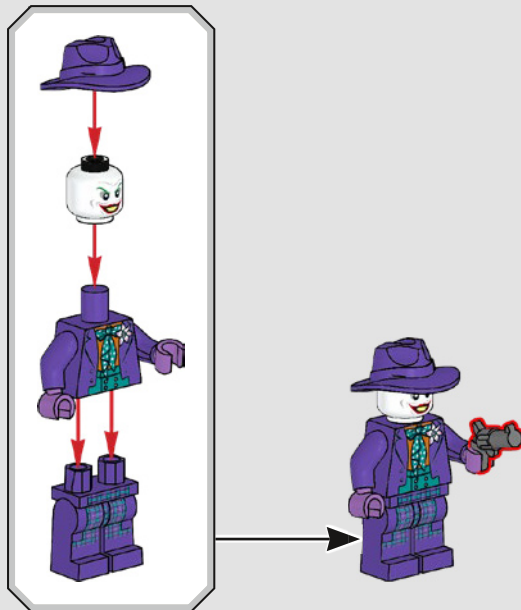
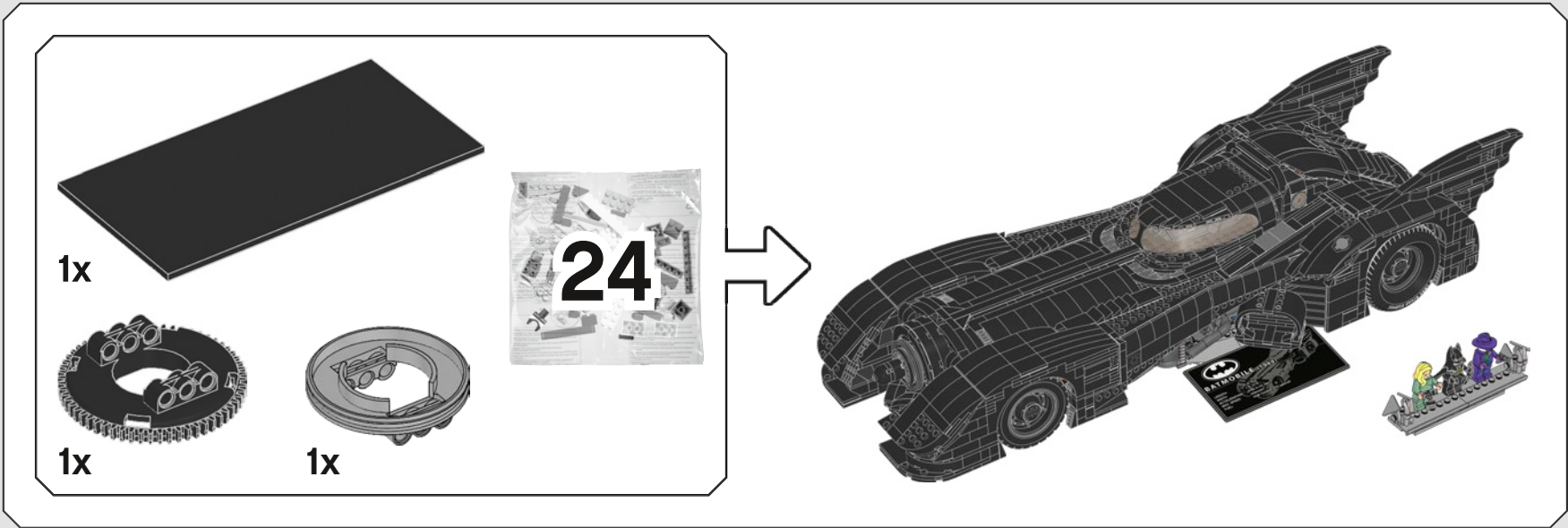

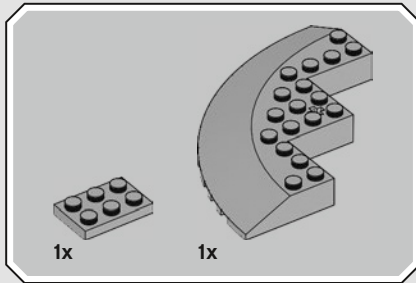

603

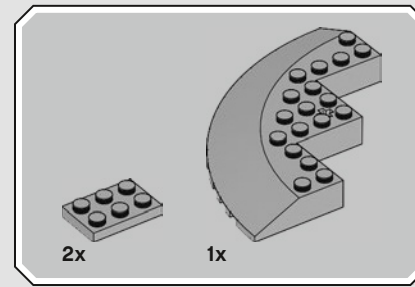
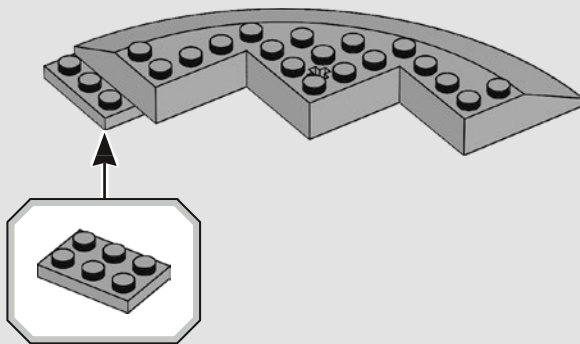

604

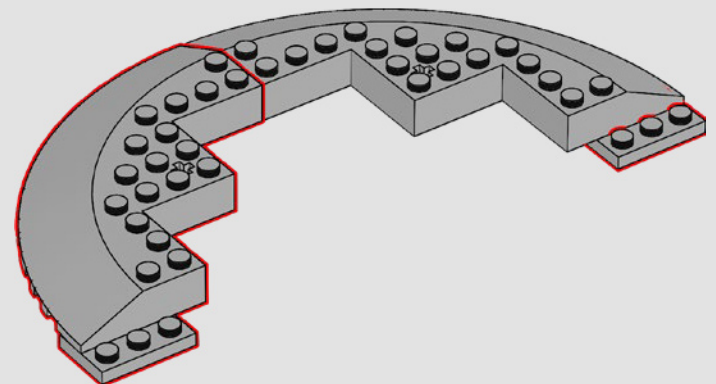

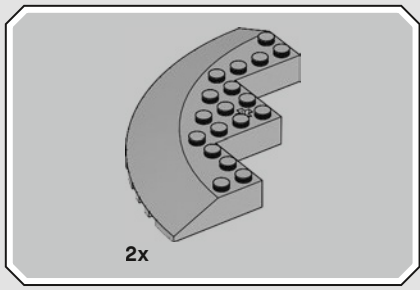

605

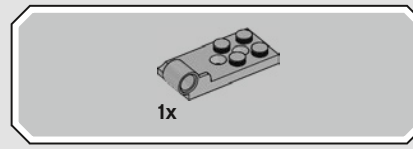
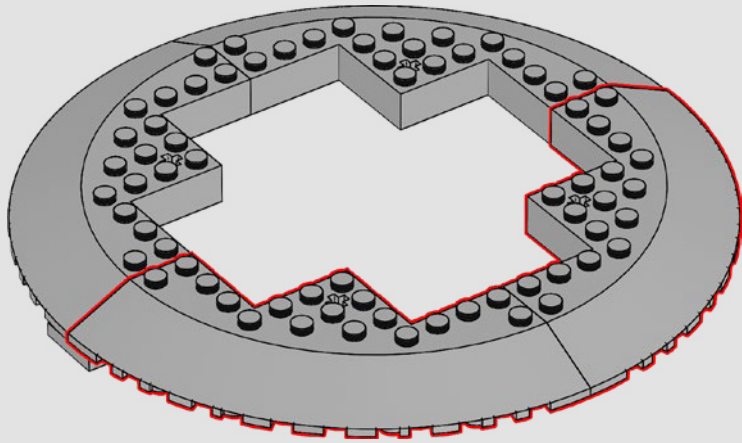

606

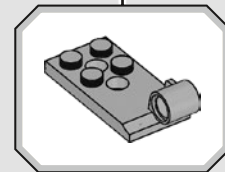
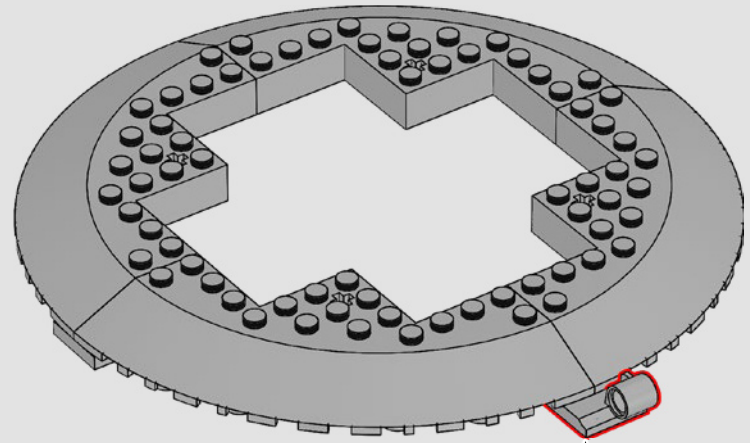

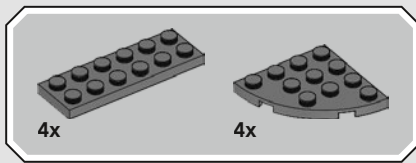

607

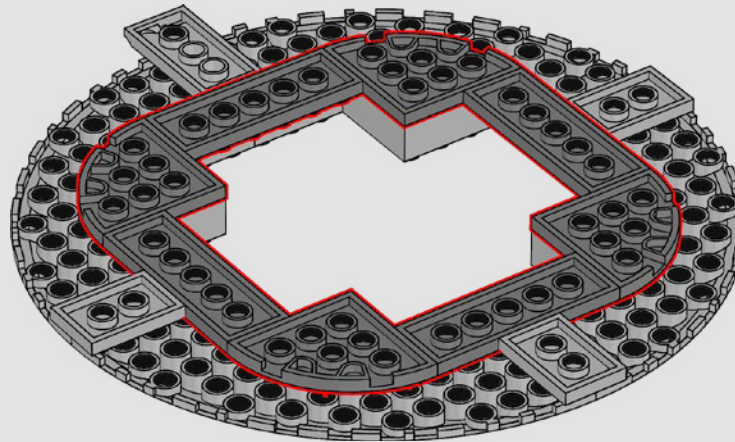

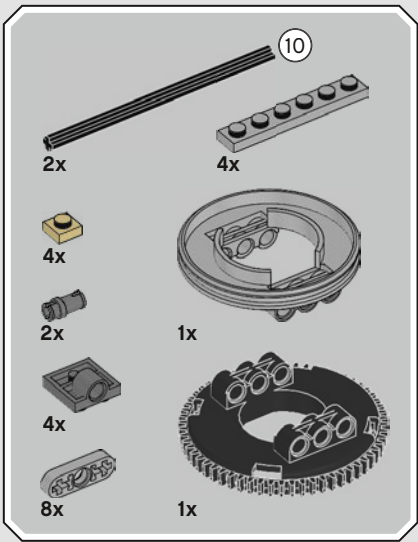

608

1

CLICK KLICK  
CLIC CLIQUE  
KATT KLIKŠKIS  
咔嗒

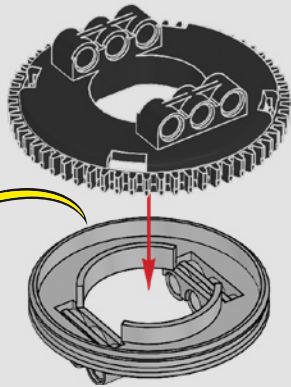

2

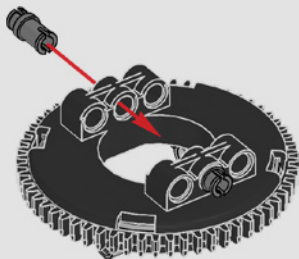

3

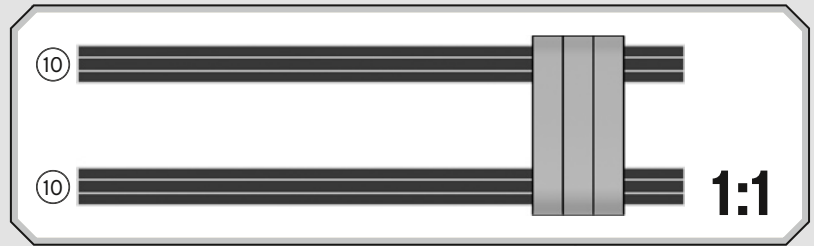
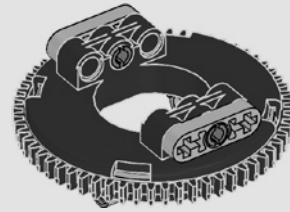

4

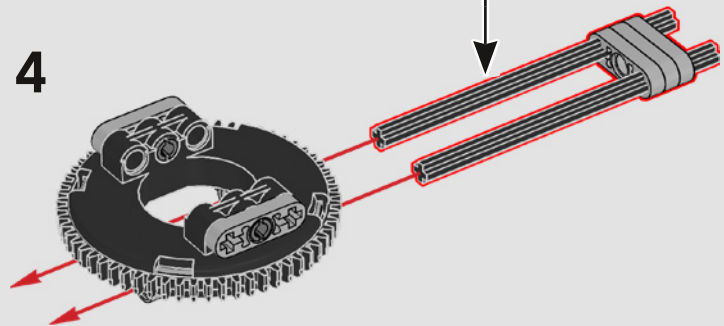

5

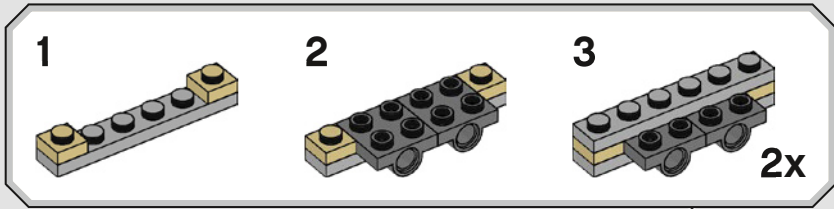
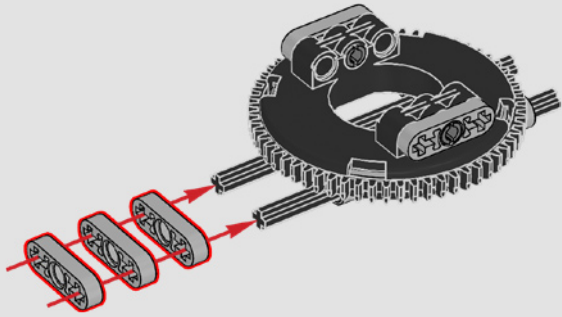

6

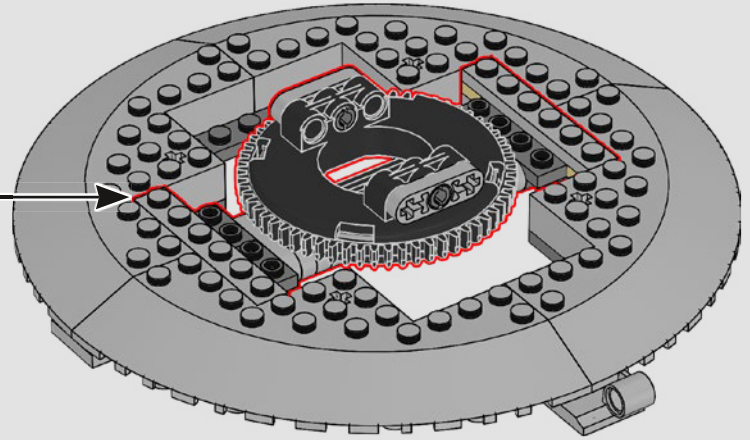
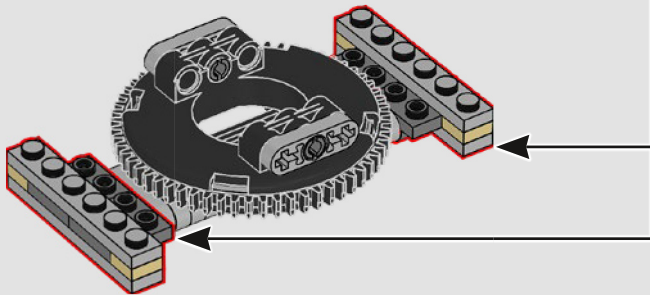

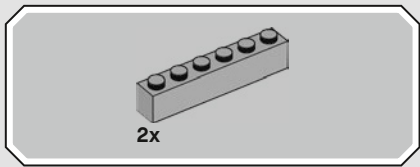

609

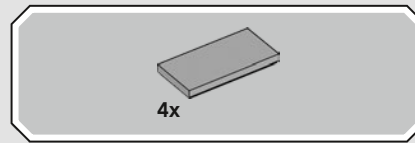
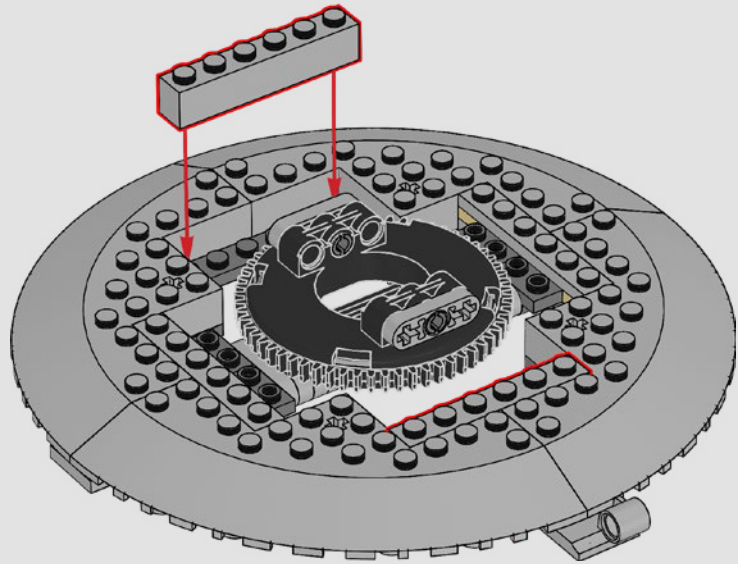

610

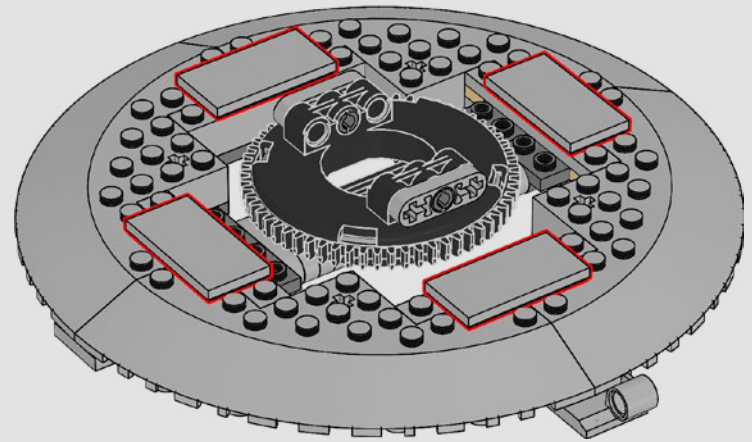



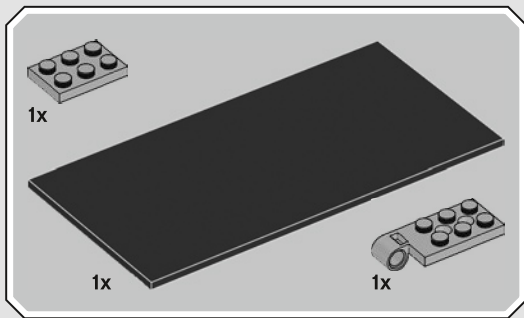

611

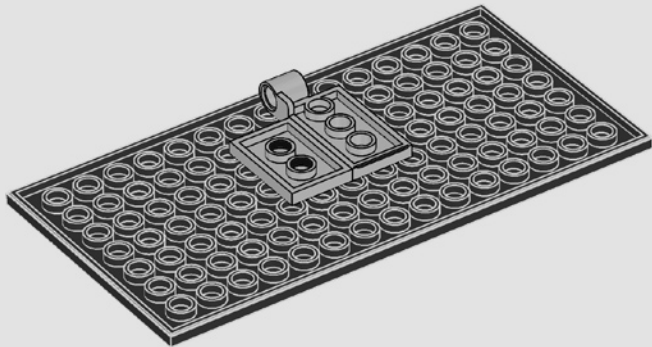

612

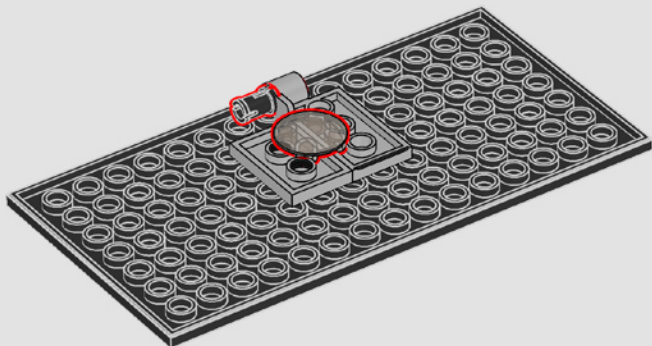

613

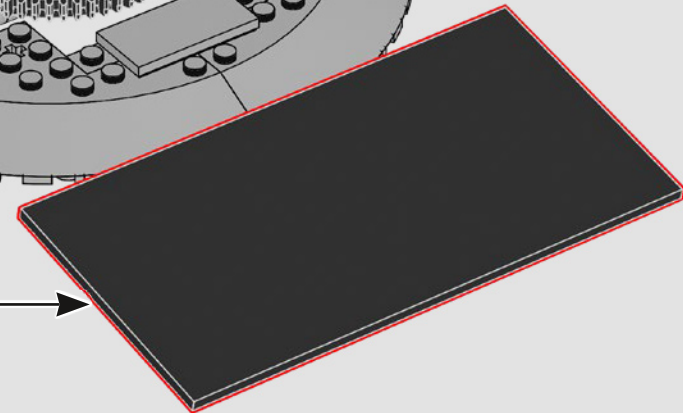
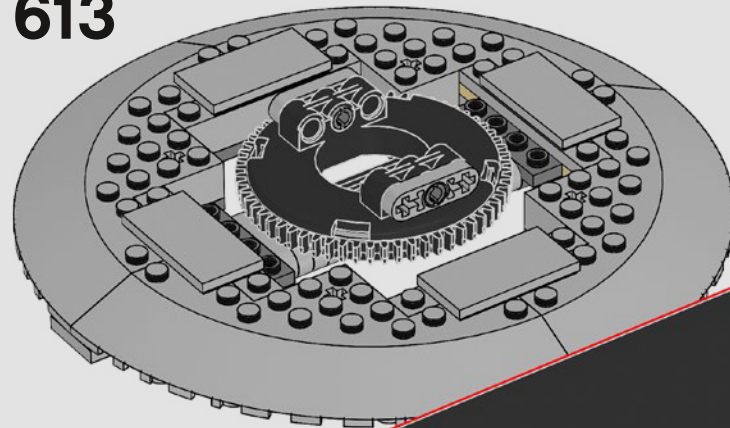

614

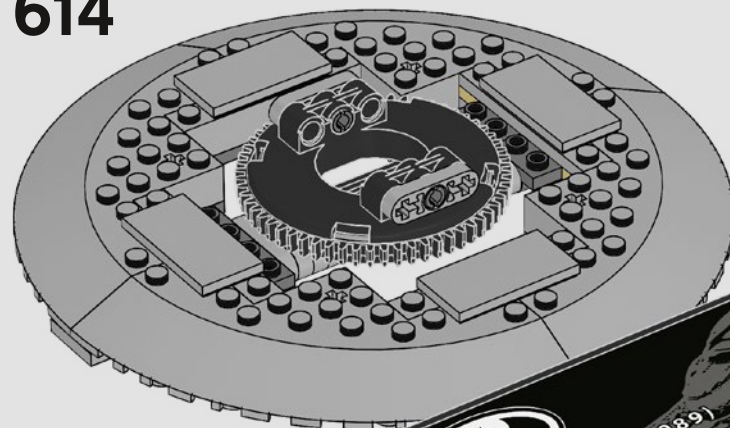



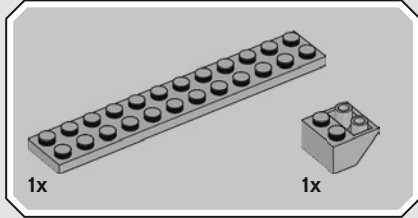
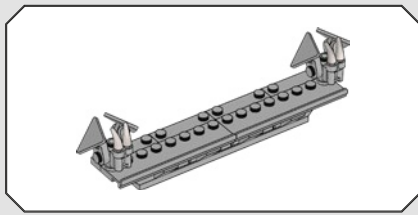

1

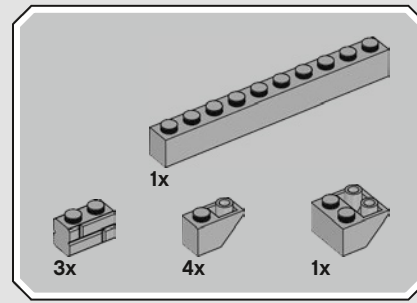
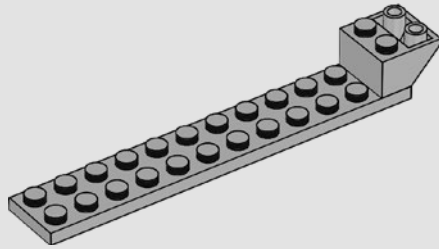

2

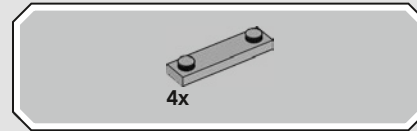
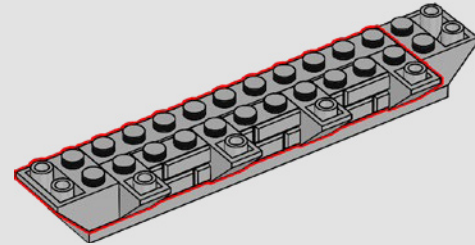

3

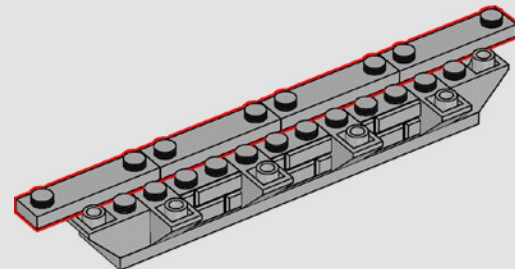

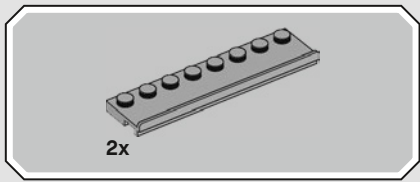

4

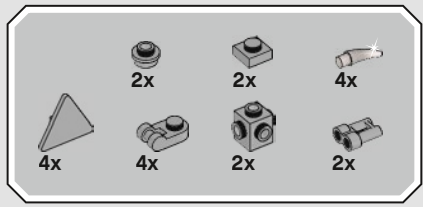
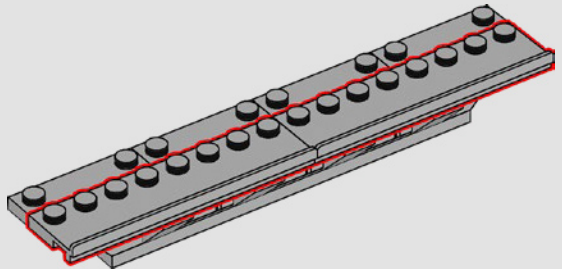

5

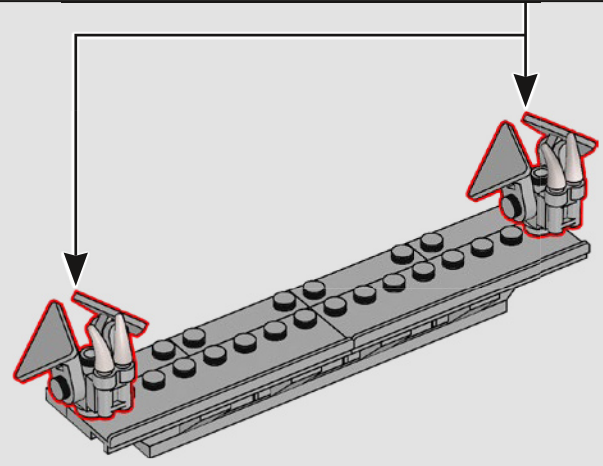
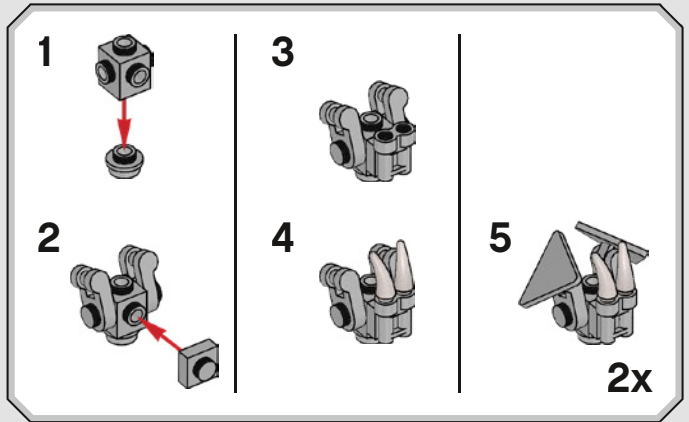

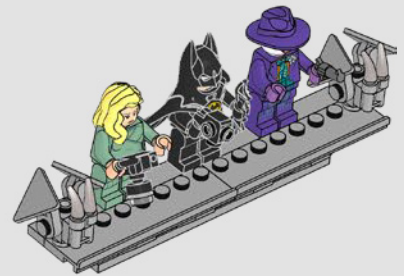
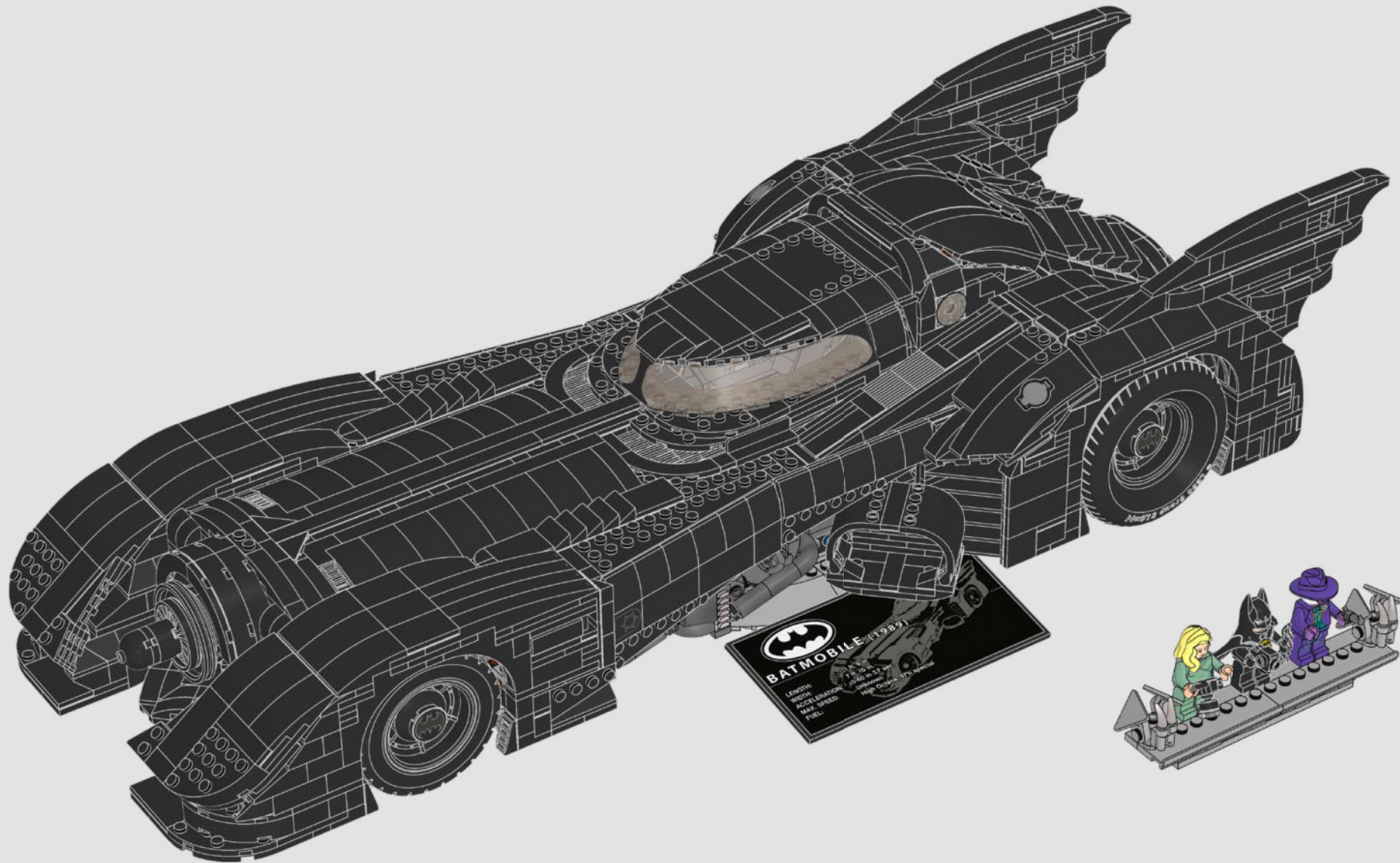



# WIN

GO TO [WWW.LEGO.COM/PRODUCTFEEDBACK](http://WWW.LEGO.COM/PRODUCTFEEDBACK) AND  
GIVE US YOUR SHORT **FEEDBACK** ABOUT THIS  
LEGO® SET FOR A CHANCE TO WIN  
A COOL LEGO PRIZE.

Terms & Conditions apply



## [LEGO.com/productfeedback](http://LEGO.com/productfeedback)

### GEWINNE

Erzähle uns auf  
[www.LEGO.com/productfeedback](http://www.LEGO.com/productfeedback)

etwas über die Erfahrungen, die  
du mit diesem LEGO® Set gemacht  
hast, und sichere dir die Chance  
auf einen coolen LEGO Preis!

Es gelten die  
Teilnahmebedingungen

### GAGNE

Rends-toi sur  
[www.LEGO.com/productfeedback](http://www.LEGO.com/productfeedback)

et donne-nous quelques com-  
mentaires sur ce produit LEGO®  
pour avoir une chance de gagner  
un prix LEGO !

Voir Conditions Générales

### GANAN

Visita  
[www.LEGO.com/productfeedback](http://www.LEGO.com/productfeedback)

y envíanos tu opinión acerca de  
este set LEGO®. ¡Participarás en el  
sorteo de un premio LEGO!

Términos y Condiciones aplicables

### 获取奖品

登录  
[www.LEGO.com/productfeedback](http://www.LEGO.com/productfeedback)

给出关于此乐高®套装的简短反馈，  
就有机会获得炫酷乐高高奖品

《条款及条件》适用

### 경품 당첨 기회

[www.LEGO.com/productfeedback](http://www.LEGO.com/productfeedback)

페이지로 이동하여 이 레고® 세트에  
대한 간략한 피드백을 보내 주시고  
멋진 레고 경품을 탈 수 있는 기회도  
잡으십시오

약관 적용

### ЗАПОЛНИ АНКЕТУ И ПОЛУЧИ ПРИЗ

Перейди по ссылке  
[www.LEGO.com/productfeedback](http://www.LEGO.com/productfeedback)

ответь всего на несколько во-  
просов об этом наборе LEGO®,  
и у тебя появится шанс выиграть  
замечательный приз от компании  
LEGO.

Применяются Условия и правила  
участия

2x 4143005	6x 6219794	6x 4159553	1x 6163442	3x 6141554	2x 6051508	2x 6174243	2x 366526	4x 6191630	12x 303926
1x 4186834	77x 4113917	4x 4579260	1x 4652294	3x 6141556	6x 4253815	18x 241226	37x 306926	2x 4273703	4x 4189064
21x 4206482	8x 6117975	2x 4565452	1x 6274718	4x 6210270	1x 4109810	32x 6047276	4x 6147050	4x 300326	2x 4124096
2x 300423	1x 6084724	1x 4666579	1x 6274879	3x 6157554	4x 6278867	2x 6236255	2x 393726	4x 300326	2x 4124096
13x 4496366	21x 4114084	1x 4523145	1x 6274892	1x 6157554	3x 403226	69x 302326	2x 4505757	1x 6192130	2x 6166859
65x 4514553	2x 4118866	2x 6047415	1x 6274892	5x 4161332	1x 4216660	8x 4598528	8x 6117973	31x 302226	6x 6133722
1x 3000023	6x 4118866	6x 6031821	1x 73587	1x 6196548	1x 614326	20x 4541191	4x 6016172	39x 6053077	38x 242026
6x 6280384	6x 4514554	4x 6132768	4x 6284070	5x 6181713	11x 4121715	2x 6069000	36x 6000650	23x 6192346	14x 235726
2x 366623	2x 4624088	2x 6257599	1x 6186675	12x 4550017	2x 6195325	13x 6092585	10x 4556158	2x 6278879	2x 4567436
1x 4163696	1x 4500453	20x 4187743	2x 614126	2x 4185058	2x 4632571	8x 6138173	2x 4107761	27x 306826	2x 6089119
15x 6257119	5x 4550323	2x 6264057	2x 6278152	2x 4180536	1x 4106552	14x 6184784	6x 6214807	8x 6211476	24x 6052126
2x 6185546	1x 4544139	1x 6274899	2x 4517925	2x 4180536	5x 4107081	14x 4121966	2x 4225201	8x 6211476	4x 4140801
2x 6237716	2x 4114001	1x 6274894	6x 6170566	5x 4160869	2x 4512363	25x 300426	4x 366026	4x 4180087	2x 6271869
2x 6261323	2x 4113988	1x 6210400	8x 6234695	1x 6173119	2x 4220539	2x 4618852	3x 4209003	1x 4580509	42x 362326
		1x 6254100	1x 4177431	41x 4548180	8x 287726	4x 4144023			

7

(3,2)



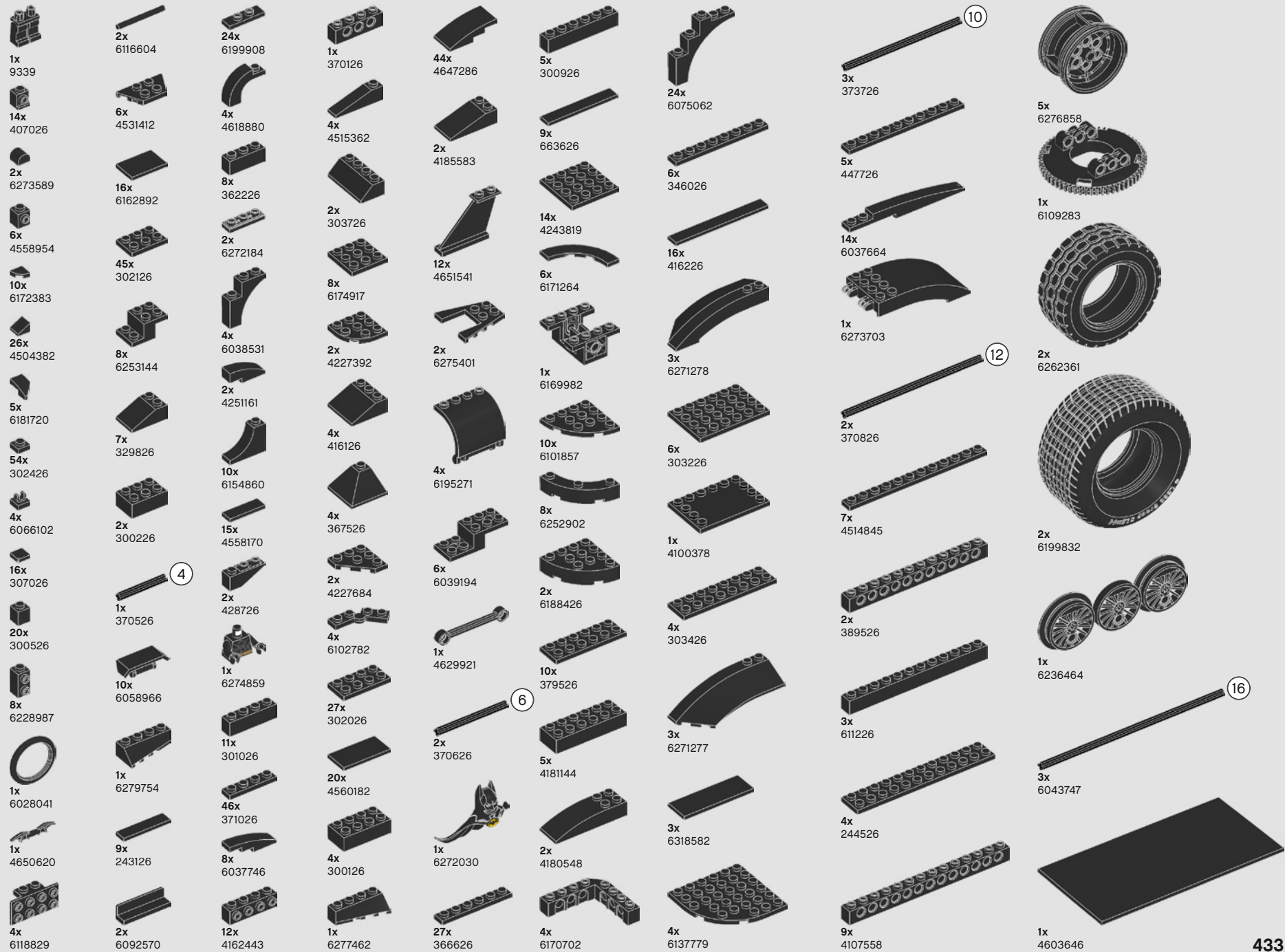

- 2x 6258607
- 2x 6245303
- 2x 4142865
- 4x 6168634
- 1x 4207715
- 10x 4140806
- 1x 362321
- 2x 6129995
- 2x 6130002
- 1x 4645733
- 1x 6212053
- 5x 6273713
- 1x 6272024
- 6x 6277483
- 6x 6252045
- 2x 6275899
- 1x 6274863
- 4x 6070698
- 1x 4107826
- 6x 302101
- 5x 370101
- 1x 6240030
- 1x 4549990
- 2x 306224
- 32x 614124
- 1x 4613258
- 1x 4173666
- 5x 4519010
- 4x 393724
- 2x 4141630
- 4x 4107823
- 12x 4503425
- 12x 302024
- 4x 389424
- 4x 6051958
- 12x 6215447
- 4x 6270108
- 6x 4619636
- 2x 6254429
- 4x 6035291
- 9x 4211252
- 2x 4211199
- 2x 4211257
- 2x 4211152
- 2x 6116613
- 15x 4211186
- 1x 4211201
- 4x 4243838
- 1x 6122217
- 26x 6168647
- 1x 6279964
- 3x 4211573
- 2x 4211483
- 4x 4211399
- 18x 6038201
- 8x 6266130
- 6x 6156875
- 2x 6168708
- 10x 6245501
- 2x 6208447
- 2x 6236391
- 1x 6197967
- 2x 6263550
- 4x 6262085
- 2x 4215513
- 2x 4211415
- 6x 6248078
- 2x 4211511
- 2x 4550170
- 4x 4211375
- 8x 4594238
- 4x 6225246
- 4x 4211886
- 2x 6179186
- 2x 4211807
- 2x 4550325
- 2x 4515374
- 6x 6168633
- 4x 4611702
- 6x 6144138
- 4x 4211414
- 4x 4211437
- 2x 4211440
- 2x 4598526
- 3x 6000066
- 2x 4585429
- 4x 4211541
- 2x 6123809
- 2x 4651063
- 8x 4654580
- 4x 6258820
- 1x 6000018
- 4x 4502595
- 2x 4211632
- 4x 4244627
- 4x 6169984
- 2x 4211660
- 7x 6093527
- 8x 4211566
- 2x 6132886
- 8x 6185676
- 2x 6102357
- 4x 6212077
- 2x 4666449
- 2x 4211436
- 2x 4234535
- 1x 4211815
- 4x 4211881
- 39x 4654577
- 4x 4211865
- 5x 4515369
- 1x 4552348
- 3x 4211621
- 1x 6273212
- 2x 4211428
- 2x 6254807
- 4x 6211969
- 4x 6225228
- 2x 4558169
- 1x 6093058
- 6x 4211396
- 2x 6171894
- 2x 6132207
- 2x 4211570
- 4x 4599498
- 8x 4211445
- 2x 4211450
- 4x 4211636
- 4x 6015347
- 4x 4211395
- 1x 6258903
- 4x 4560183
- 2x 4558169
- 1x 6093058
- 6x 4211396
- 2x 6171894
- 2x 4211393
- 8x 4211438
- 4x 4211549
- 2x 4211640
- 2x 4211795
- 2x 4211452
- 1x 4211542
- 4x 6249901
- 1x 6109285
- 4x 4211442



14x  
4211716



1x  
4211406

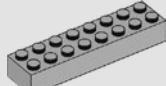

1x  
6037399

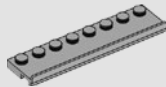

2x  
4222019

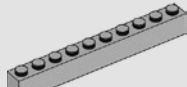

1x  
4211521



12x  
4211374

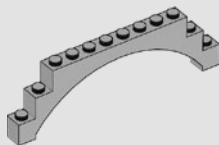

1x  
6246844



1x  
4211360

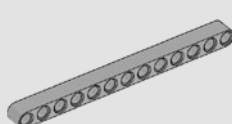

1x  
4522934

13



8x  
4504378



2x  
4211044



4x  
6228923



6x  
4210639



6x  
6225494



12x  
4211050



2x  
6270008



5x  
4210782



5x  
4210788



19x  
4567887



4x  
4211042



3x  
6055313



2x  
6100931



2x  
4249139



2x  
4210888



4x  
4210719



8x  
4211090



4x  
6100030



1x  
4211029



2x  
6012451



2x  
4210762



8x  
6164073



4x  
6029948



1x  
4210900



32x  
6092572



2x  
4210978



1x  
4211039



4x  
4211052



21x  
4211063



2x  
4211088



2x  
6019987



16x  
4211111



10x  
6069164



2x  
6117972



4x  
6000606



7x  
4211087



2x  
6250018



8x  
4581225



1x  
4610374



1x  
6013082



8x  
4211094



4x  
6047417



2x  
6000853



4x  
6247784



6x  
4211060



10x  
4211109



46x  
4210635



8x  
6265306



4x  
6015356



2x  
4210665



2x  
6257335



14x  
4211133



4x  
4652259



2x  
4211104



4x  
6172811



2x  
4568734



12x  
4547958



4x  
4610378



10x  
4211046



2x  
6118832



2x  
4582257



10x  
4211043



6x  
4211105



5x  
6099909



4x  
6083620



10x  
4211001



4x  
6042955



10x  
4213607



4x  
6092649



7x  
4211053



2x  
6008715



2x  
4211103



1x  
4296788



4x  
6178912



5x  
4210897



4x  
6010862



7x  
6102774



10x  
4560184



2x  
4211065



1x  
6005668



5x  
4211085



2x  
4508553



2x  
6106191



2x  
4211056



4x  
4539429



4x  
4222042



12x  
4211002



5x  
4210998



1x  
4211008



2x  
6199511



4x  
4210997



2x  
4257526



2x  
4211107



1x  
4210794



4x  
6133611



12x  
4210963



3x  
4211067



1x  
4211114



2x  
6000970

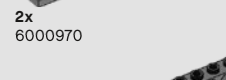

2x  
4256828



2x  
4210796

4

5.5



Customer Service  
Kundenservice  
Service Consommateurs  
Servicio Al Consumidor  
LEGO.com/service or dial



: 00800 5346 5555  
: 1-800-422-5346



TM

**VISIT / VISITEZ LE / VISITA**  
**LEGO.COM/DC-SUPERHEROES**

Find related products, videos,  
and an endless brooding darkness.

Découvrez des produits connexes, des vidéos  
et des ténèbres obscures sans fin.

Encuentra productos relacionados, videos  
y una inagotable fuente de melancólica oscuridad.

LEGO and the LEGO logo are trademarks of the/sont des marques de commerce du/son marcas registradas de LEGO Group. ©2019, 2020 The LEGO Group.



**DC** BATMAN and all related characters and elements  
© & ™ DC Comics and Warner Bros. Entertainment Inc.

**WB** SHIELD: © & ™ WBEL  
(s19)



6362926