



Mixels



KAMZO
41538



SPUGG
41542



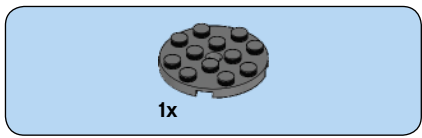

1



2



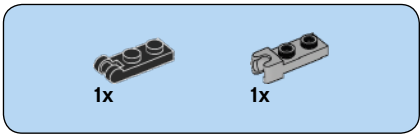

3

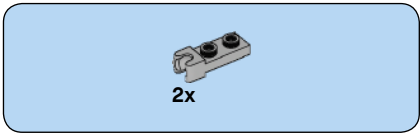
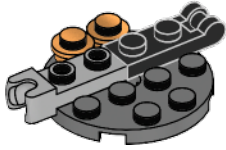

4

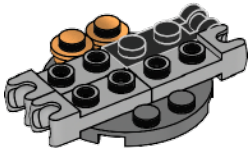

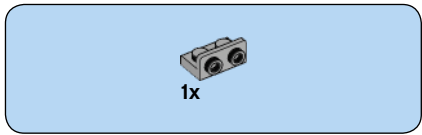

5

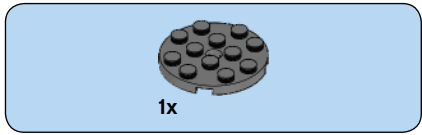
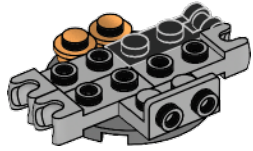

6

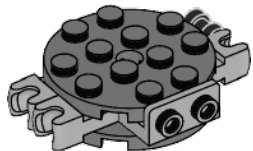

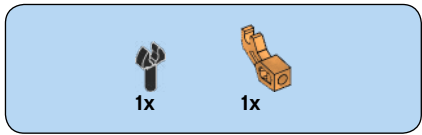

7

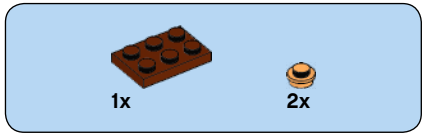
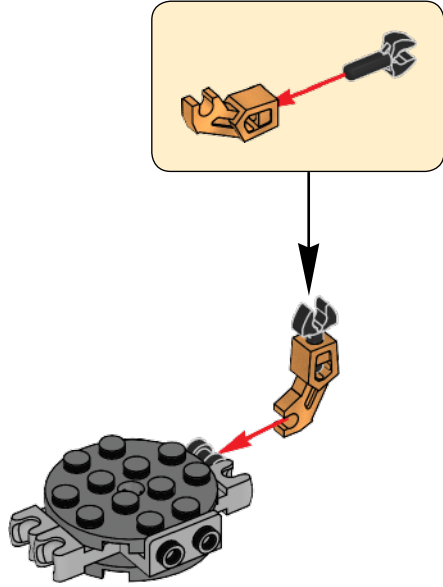

8

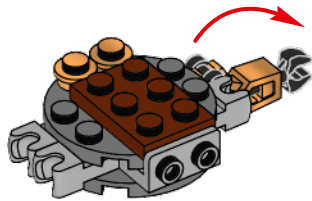

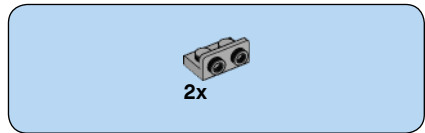

9

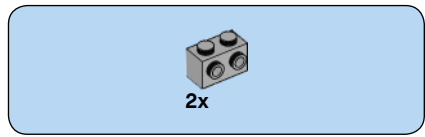
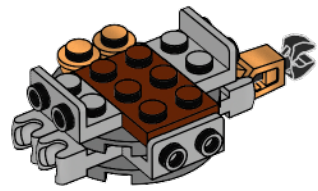

10

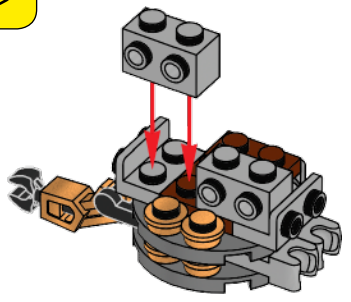
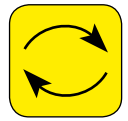

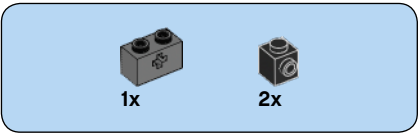

11

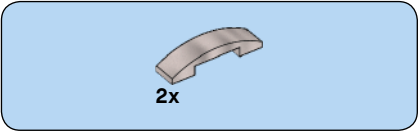
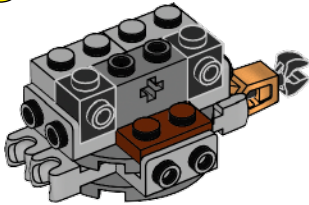

12

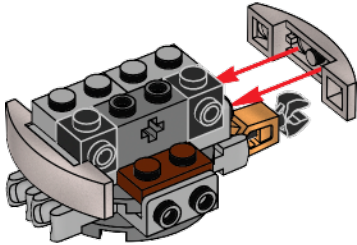

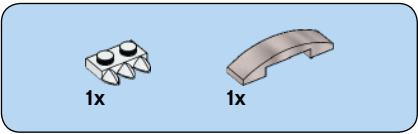

13

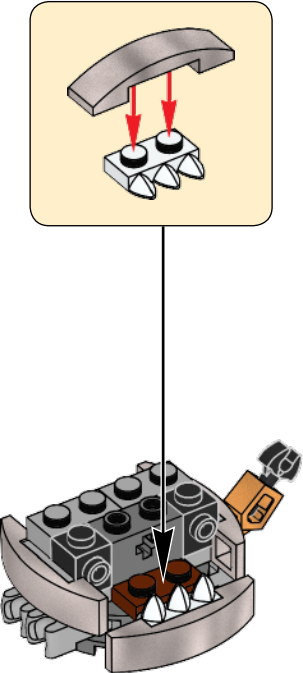

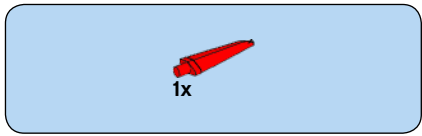

14

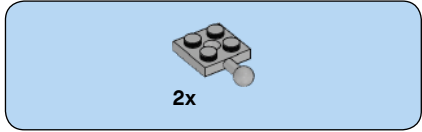
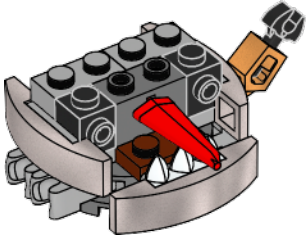

15

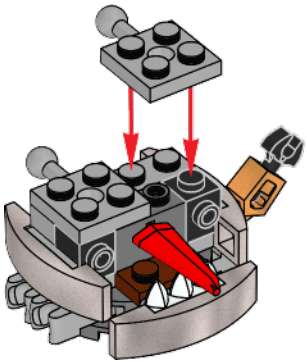

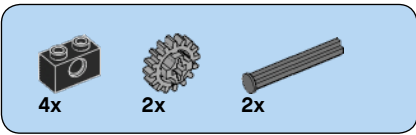

16

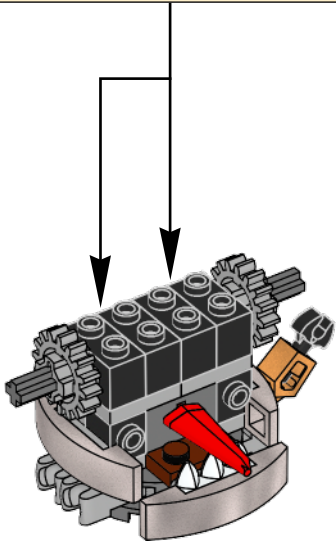
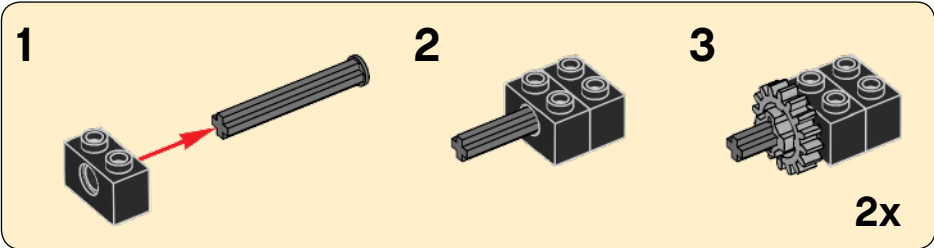

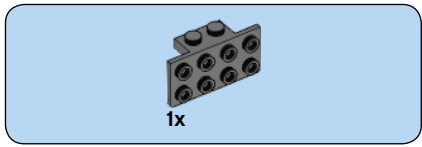

17

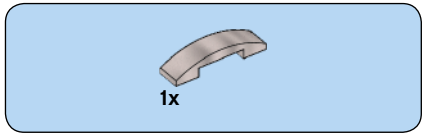
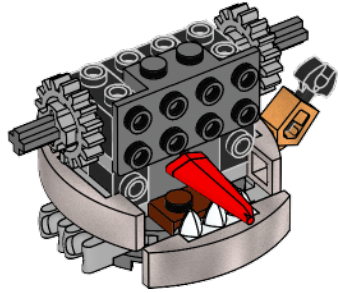

18

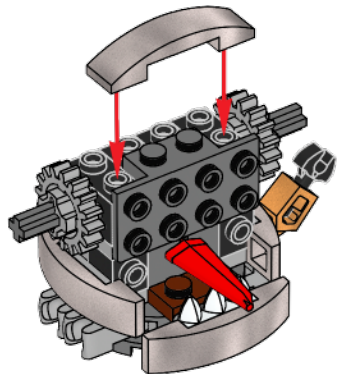

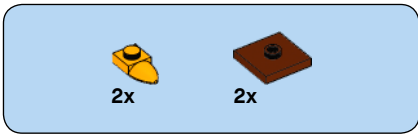

19

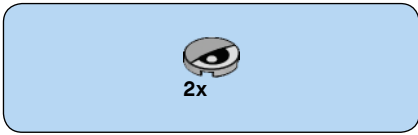
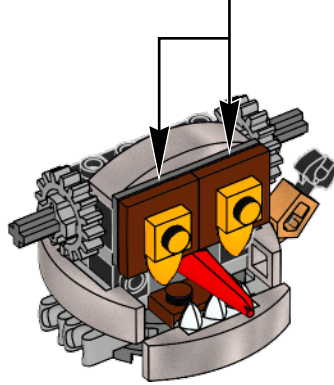
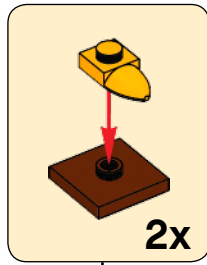

20

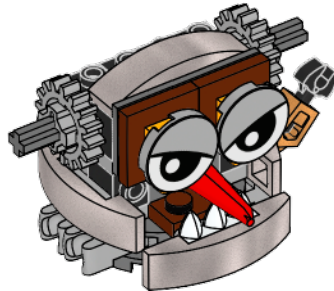

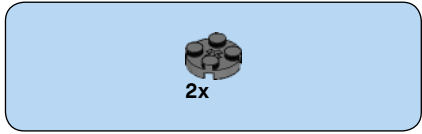
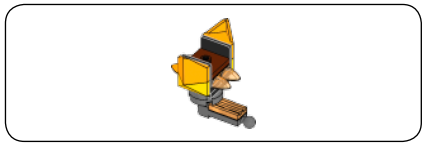

21

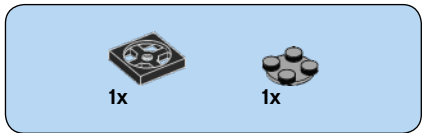
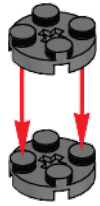

22



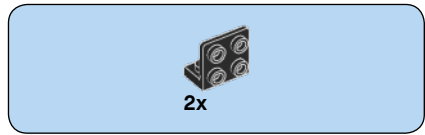

23

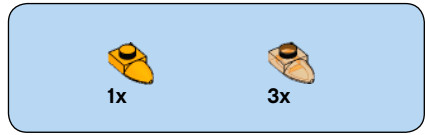
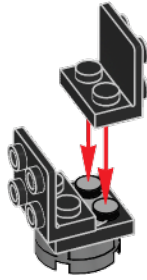

24

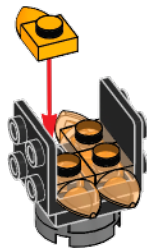

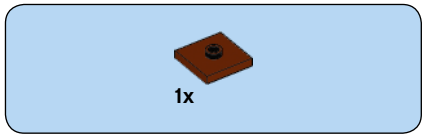

25

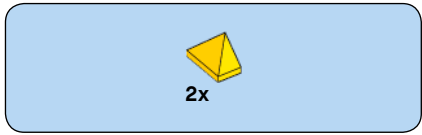
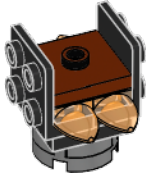

26

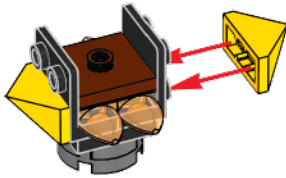



2x

27

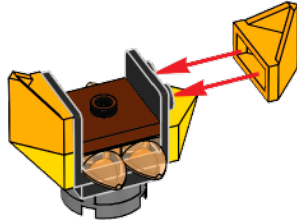

1x

28

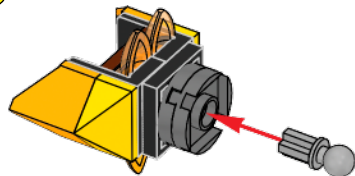

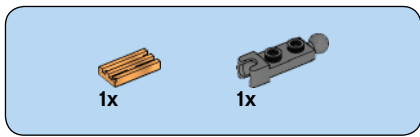

29

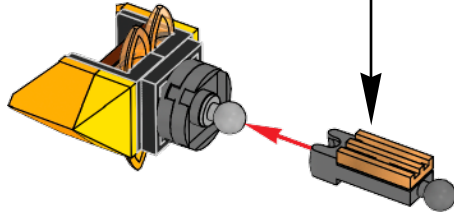
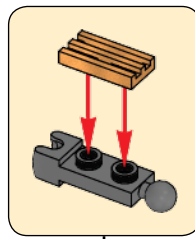

30

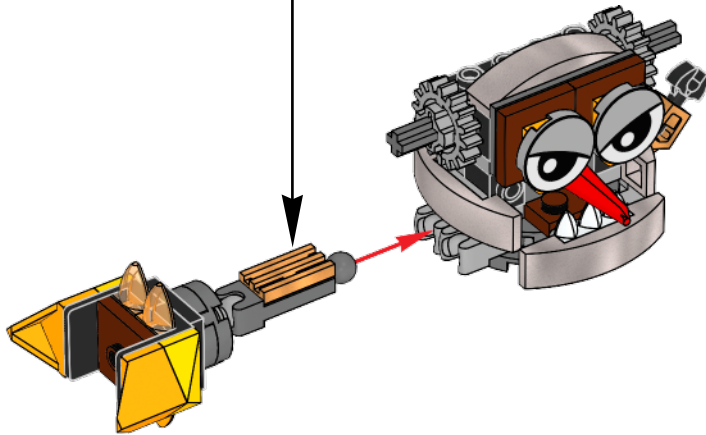

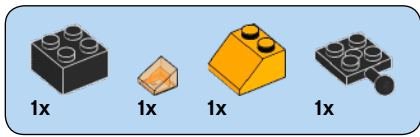

31

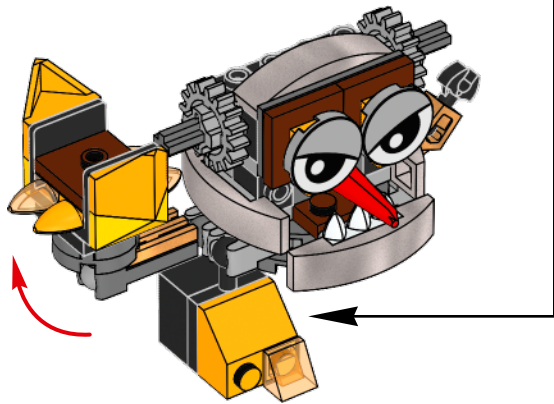
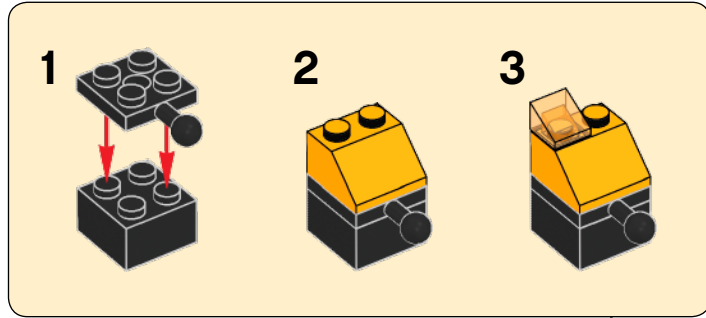

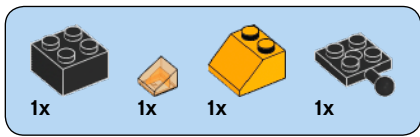

32

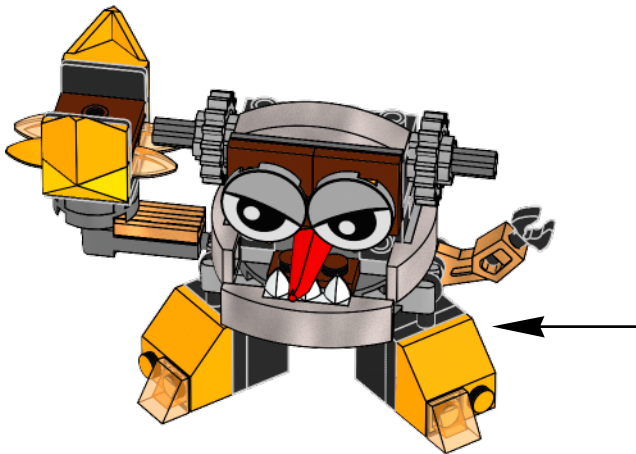
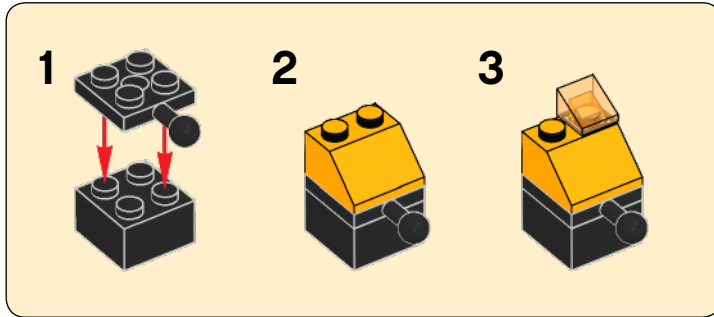



LEGO, the LEGO logo and MIXELS are trademarks of the/sont des marques de commerce du/son marcas registradas de LEGO Group. ©2015 The LEGO Group.

TM & © 2015 Cartoon Network