





[LEGO.com/sustainable-packaging](https://www.lego.com/sustainable-packaging)



 **FR**
DONNEZ
OU
RECYCLEZ

 OU  OU 

ASSOCIATION MAGASIN DÉCHÈTERIE

Adresses sur [quefairedemesdechets.fr](https://www.quefairedemesdechets.fr)

LEGO® VIP

1. SIGN UP
INSCRIVEZ-VOUS
REGÍSTRATE

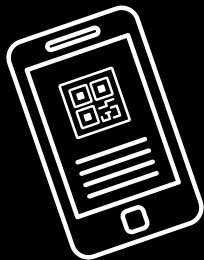

2. EARN POINTS
FOR PURCHASES
GAGNEZ DES
POINTS POUR
VOS ACHATS
GANA PUNTOS
POR TUS COMPRAS



3. REDEEM POINTS FOR REWARDS,
EXPERIENCES, DISCOUNTS & MORE
ÉCHANGEZ DES POINTS CONTRE DES
RÉCOMPENSES, DES EXPÉRIENCES,
DES RÉDUCTIONS ET PLUS ENCORE
CANJEA PUNTOS POR RECOMPENSAS,
EXPERIENCIAS, DESCUENTOS Y
MUCHO MÁS

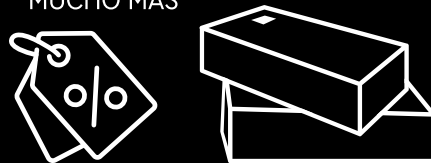

LEGOLAND®





COLTIVA IL TUO DITO CREATIVO

🪴 "Questi semplici ma prolifici vasi di terracotta sono gli ultimi arrivati nella nostra Collezione Botanica LEGO®: tre gruppi di piante iconiche ed esotiche, miniaturizzate per portare il classico fascino LEGO nella tua casa. Dalle piante d'appartamento che amano l'umidità alle piante grasse del deserto, fino agli esemplari carnivori, questo vibrante mix può essere esposto in un unico gruppo o in piccoli sotto-gruppi di tre, per infondere colore e divertimento nella tua abitazione tutto l'anno. Con le istruzioni create per invitare amici o persone care a partecipare alla costruzione, ci auguriamo che potrete godervi insieme il vostro giardino d'inverno!"

THEO BONNER
LEGO® Model Designer





PIANTE TROPICALI

▣ Le foreste pluviali tropicali coprono solo circa il 6% della superficie terrestre, ma ospitano quasi i due terzi di tutte le specie vegetali, comprese piante con proprietà medicinali utilizzate nel trattamento di diverse malattie. Le condizioni calde e umide consentono a migliaia di fiori, alberi e cespugli vibranti e rigogliosi di prosperare e servire da rifugio e nutrimento sia per gli animali sia per gli esseri umani.



(Oxalis triangularis)

OSSALIDE TRIANGOLARE

Pianta perenne originaria dell'Argentina, Bolivia, Brasile, Paraguay e Perù.



(Crassula ovata)

ALBERO DI GIADA

Una grande succulenta originaria del Sud Africa e del Mozambico.



(Anthurium andraeanum)

ANTURIO

Una pianta da fiore originaria della Colombia e dell'Ecuador.

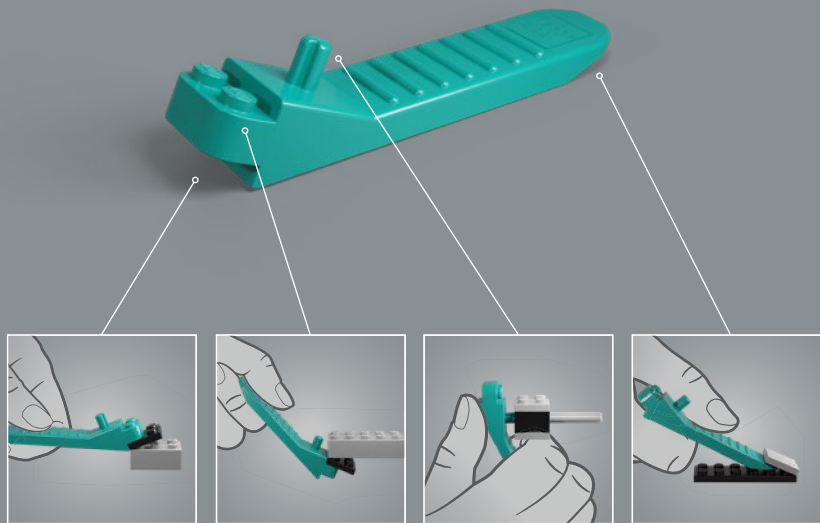



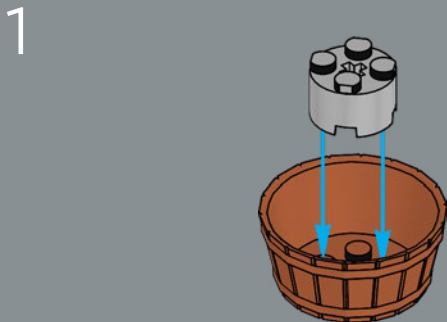
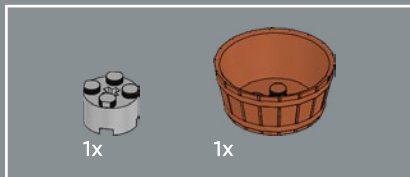

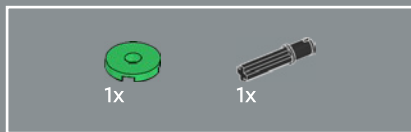

2

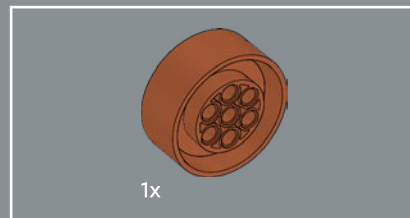
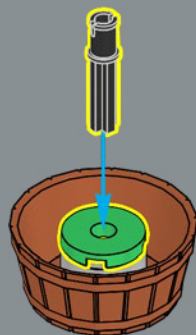

3

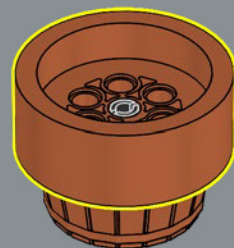



4

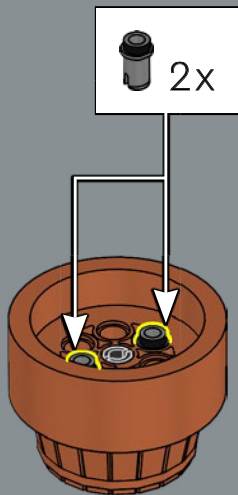

5

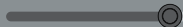

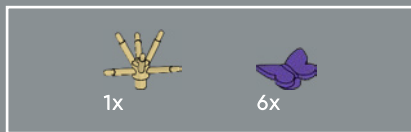

6

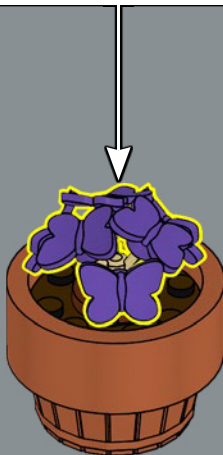
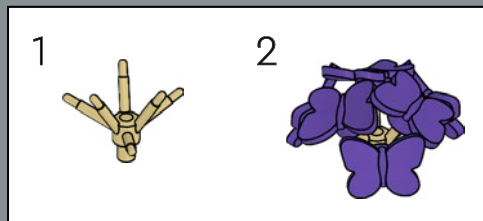

A prima vista, l'*Oxalis triangularis* potrebbe essere confusa con un folto gruppo di farfalle, quindi quale modo migliore per catturare l'aspetto inconfondibile di questa pianta se non utilizzando la farfalla LEGO® in un colore completamente nuovo?

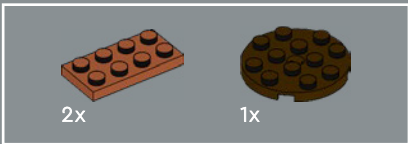
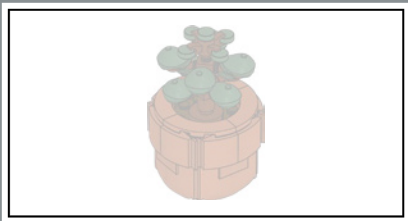

1

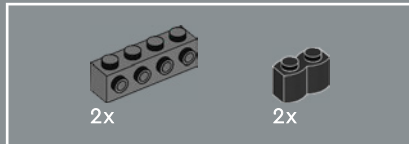
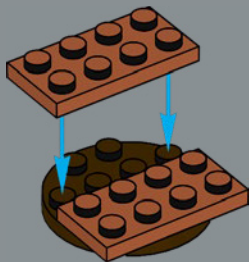

2

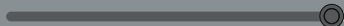
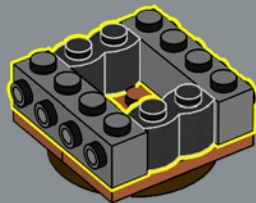

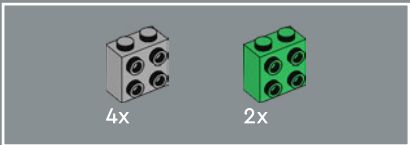

3

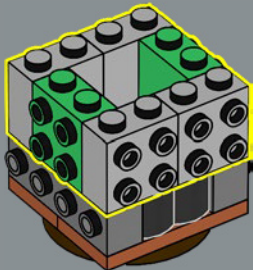

4



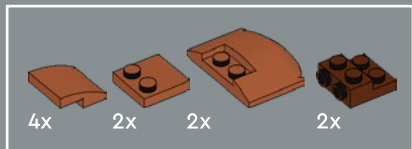

5

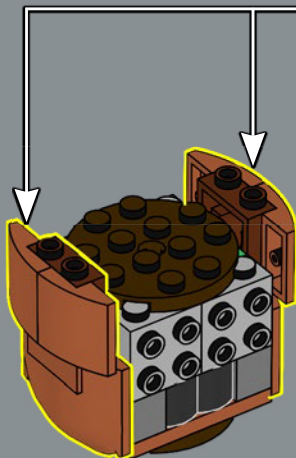
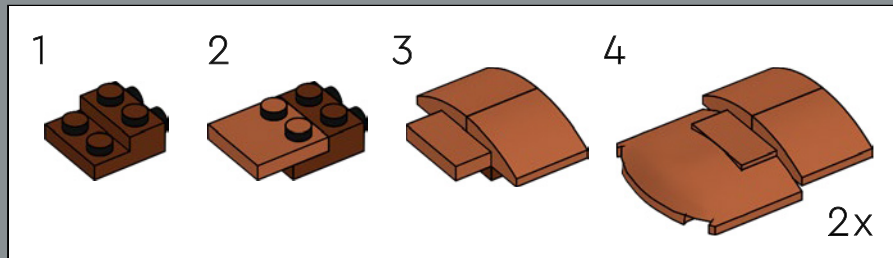

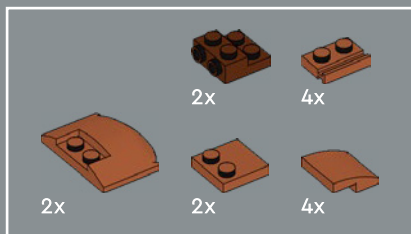

6

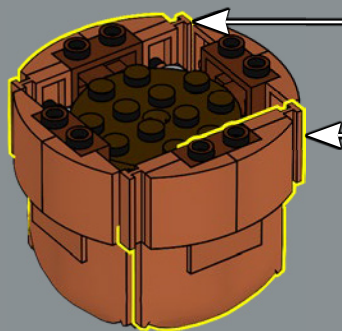
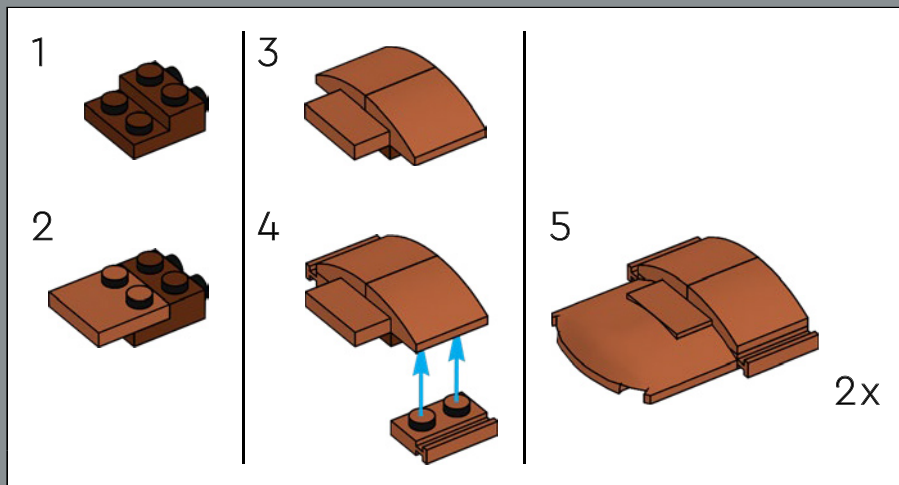

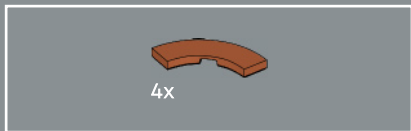

7

Hai mai pensato di imparare l'arte di coltivare alberi bonsai?
Gli alberi di giada crescono rapidamente, sono molto versatili e possono essere facilmente potati, a seconda delle proprie preferenze.

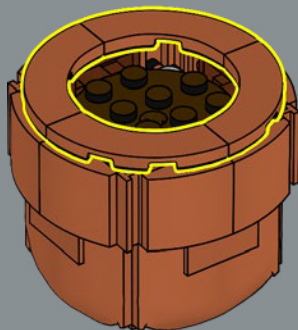



8



9

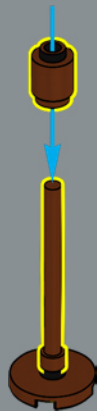



10

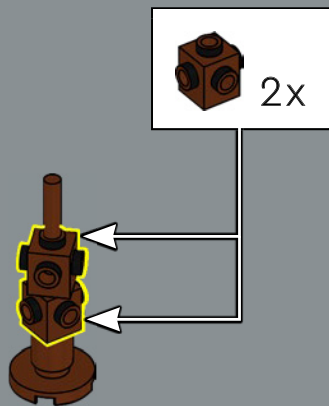

11

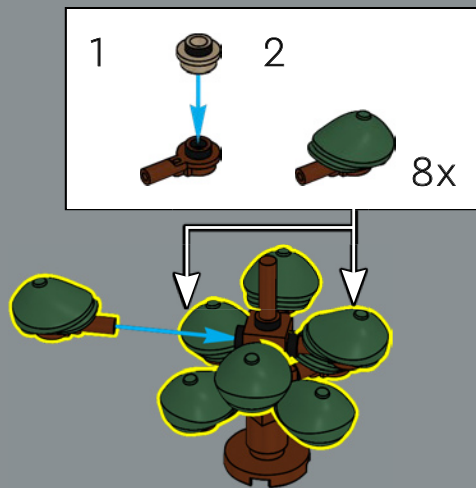



12

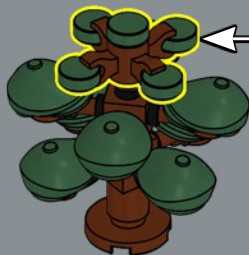

13

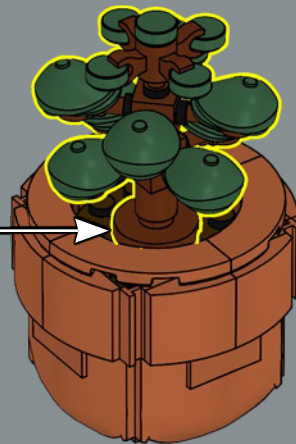

Novità! Novità! Scopri tutto qui! La coppola in un nuovo colore! Per riprodurre le spesse foglie dell'albero di giada, abbiamo utilizzato otto "coppole" LEGO®, usate per la prima volta per la minifigure LEGO da collezione del Ragazzo giornale.

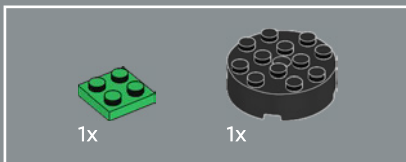
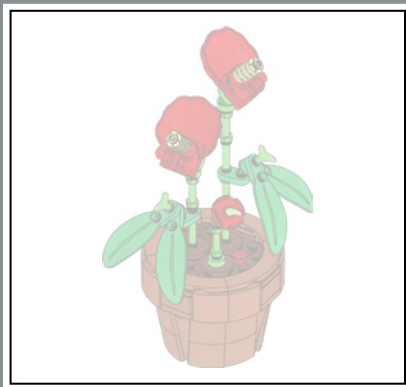

1

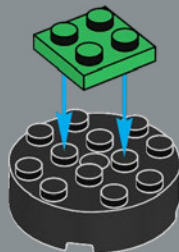

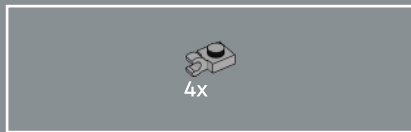

2

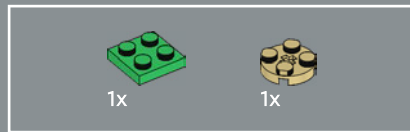
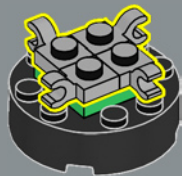

3

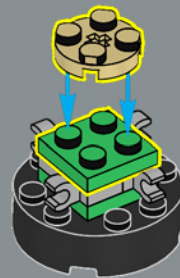

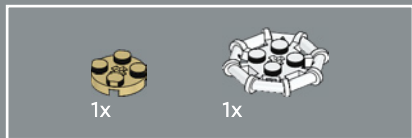

4

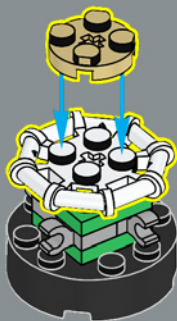

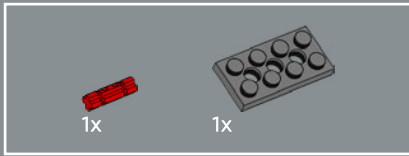

5

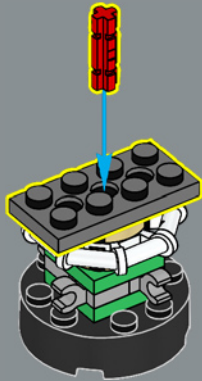

6



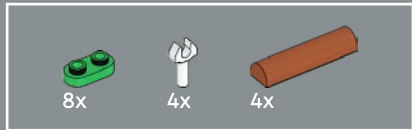

7

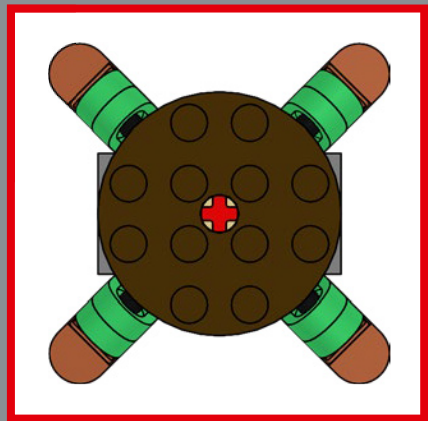
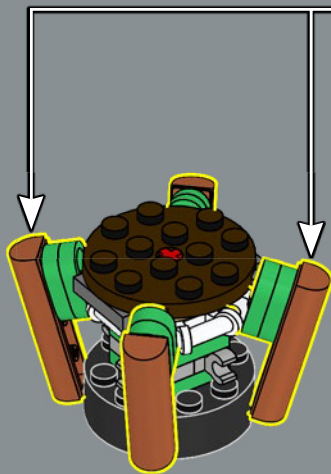
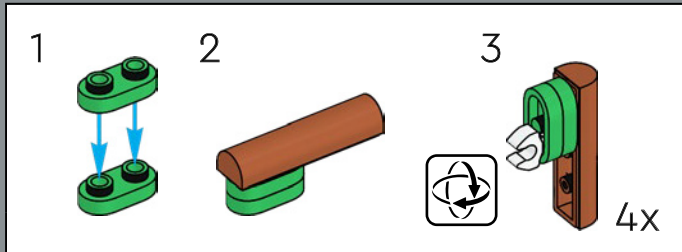

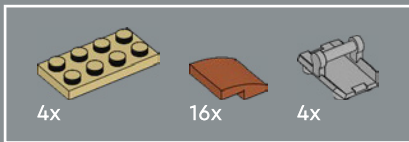

8

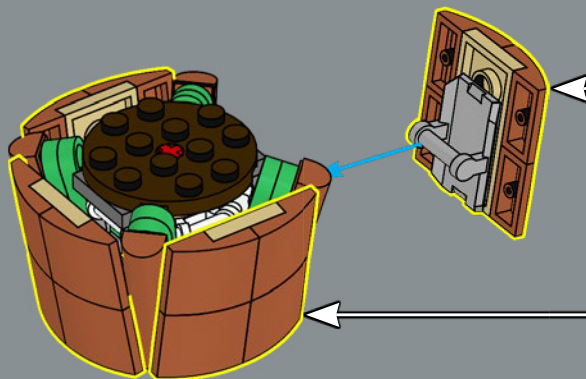
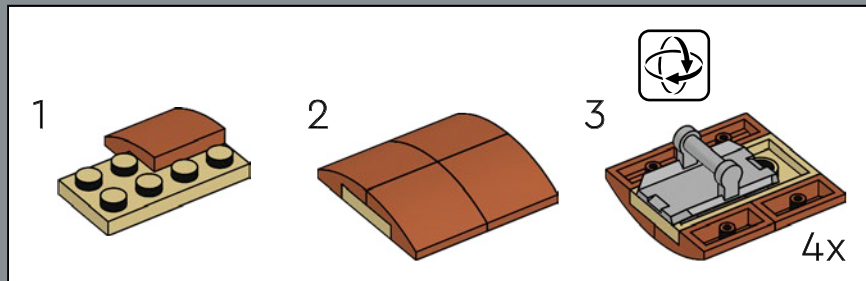

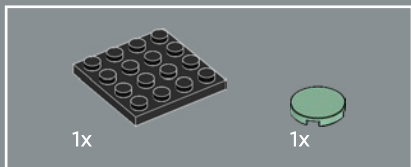
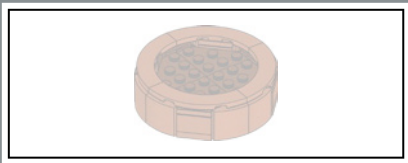

9

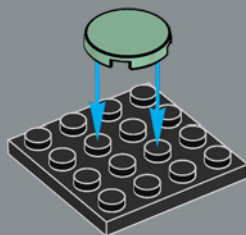



10

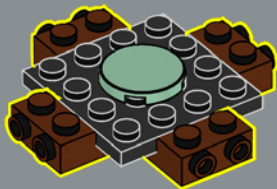

11

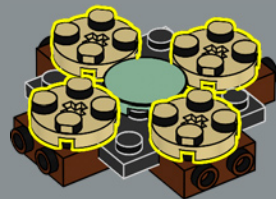



12

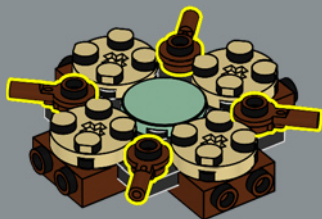

13

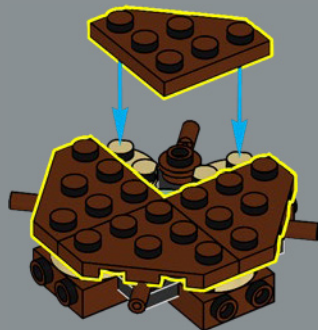

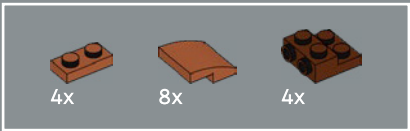

14

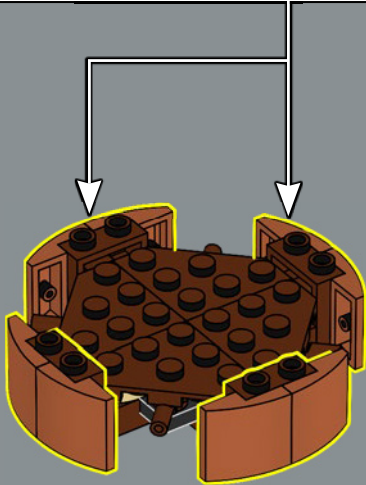
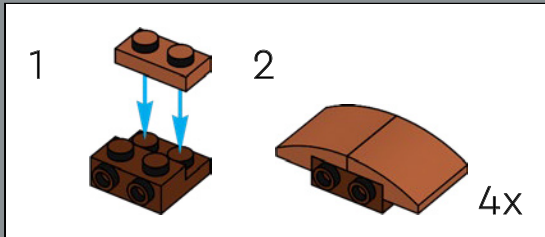



15

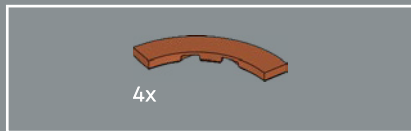
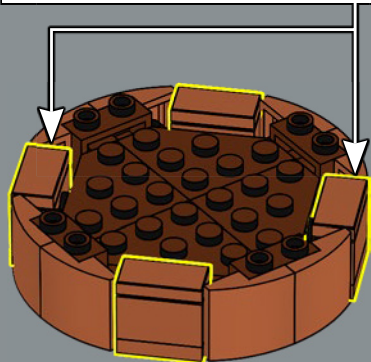
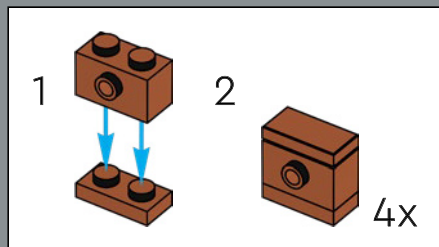

16

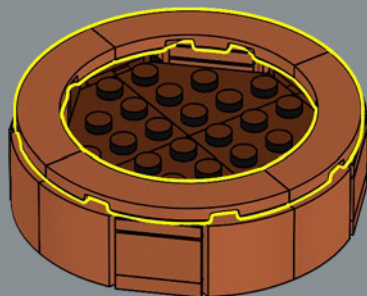

Gli anturi sono sensibili ai parassiti come gli afidi e i ragni rossi, quindi avere una coccinella affamata nel vaso è un buon modo per prenderti cura della tua pianta.

17

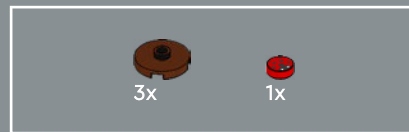
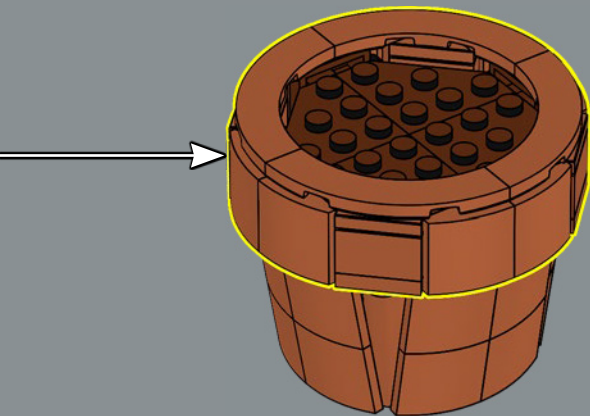

18

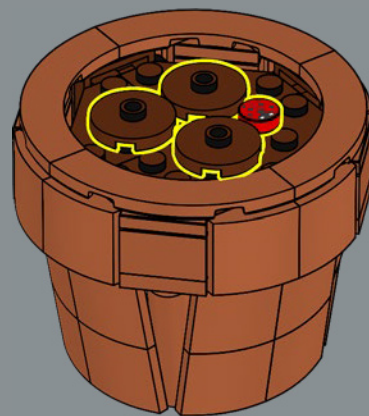

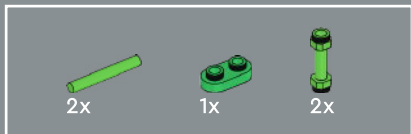

19

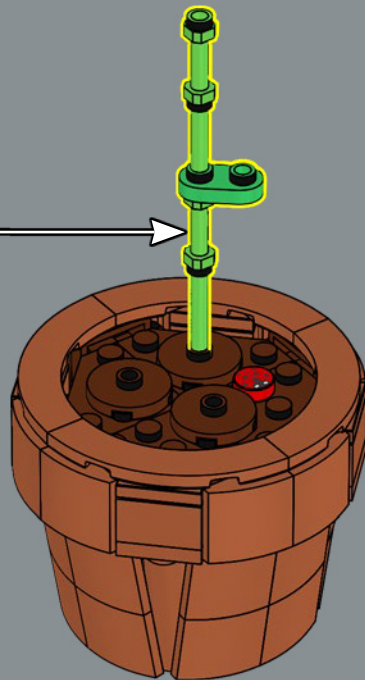
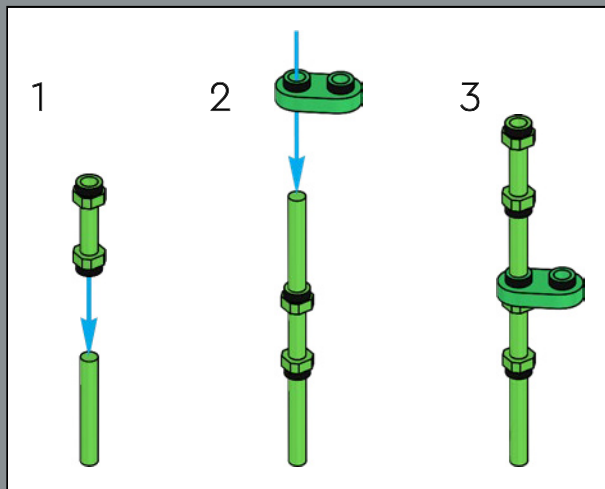

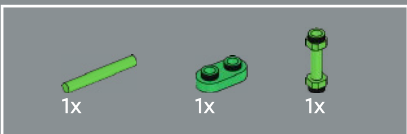

20

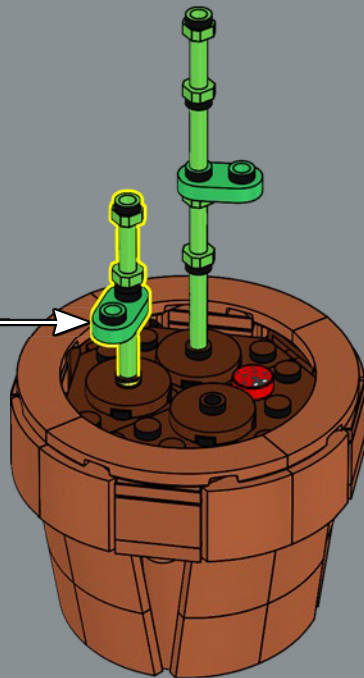
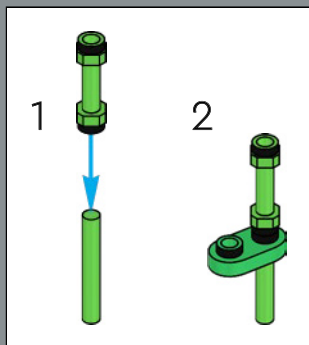

Questa specie è famosa per il suo attraente fiore, che consiste di uno spadice (a forma di pannocchia, il vero e proprio fiore) e una spata, la foglia di colore rosso fiamma. Oggigiorno, sono disponibili numerose specie, con fiori di colore diverso.

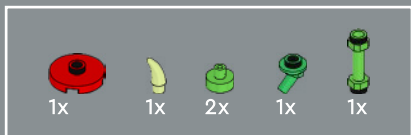

21

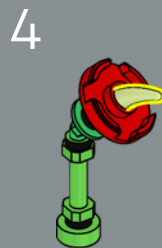
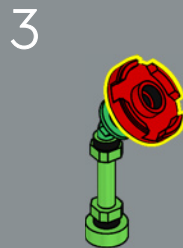
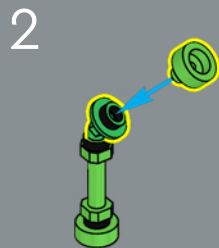
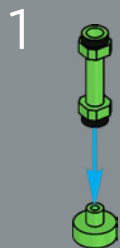

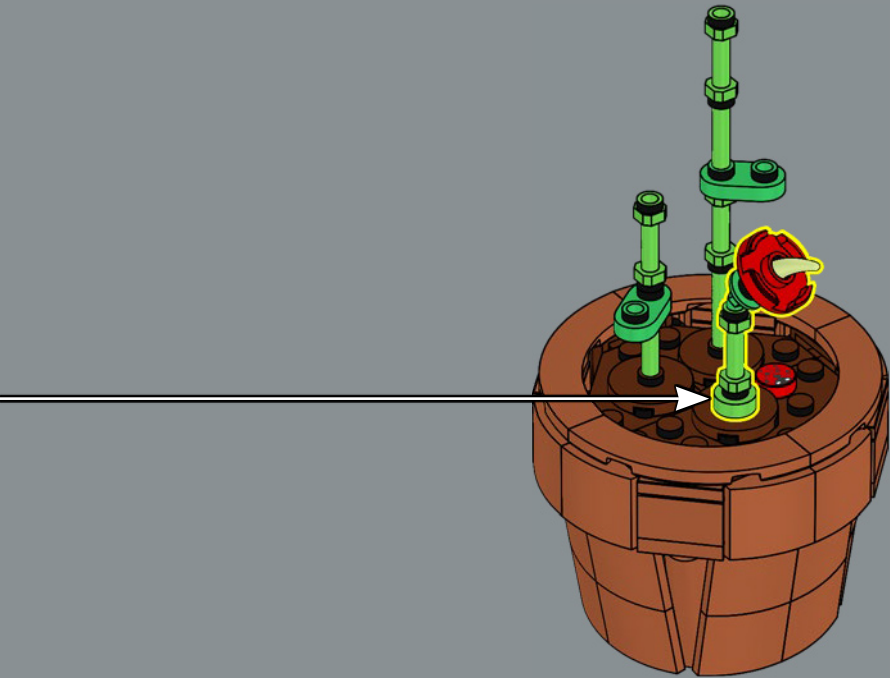

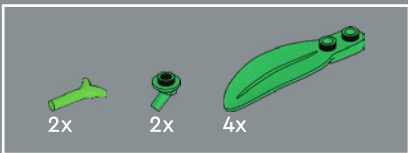

22

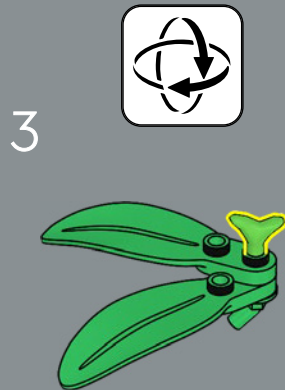
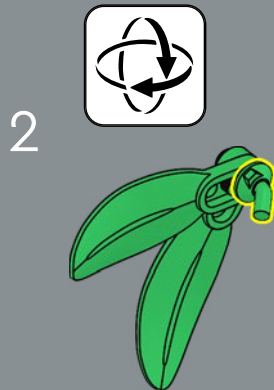
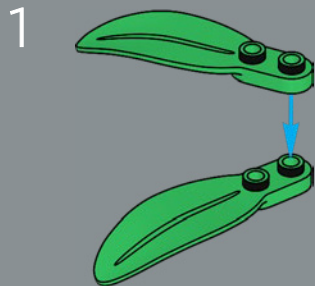

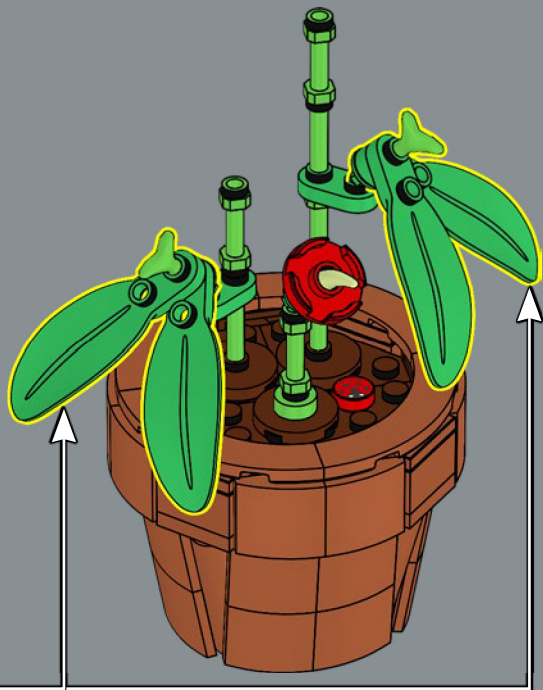

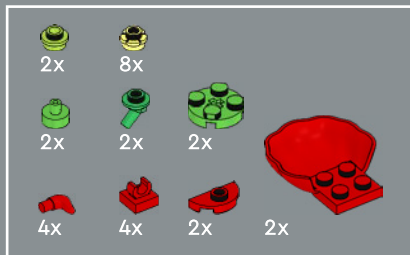
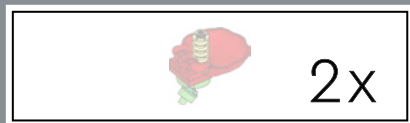

23

1

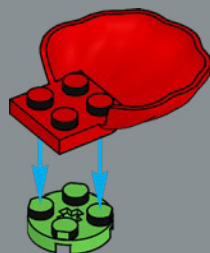

2

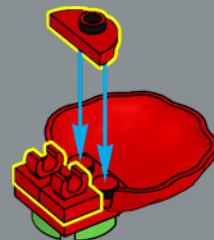

Per riprodurre l'iconico fiore dell'anturio,
abbiamo utilizzato elementi conchiglia LEGO®
in un nuovo colore.

3

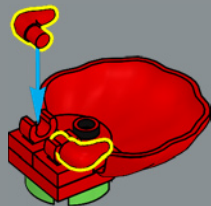

4

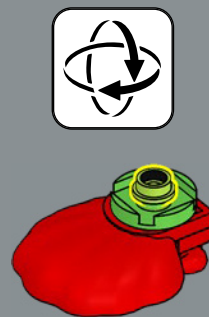

5

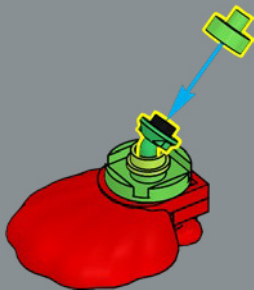

6

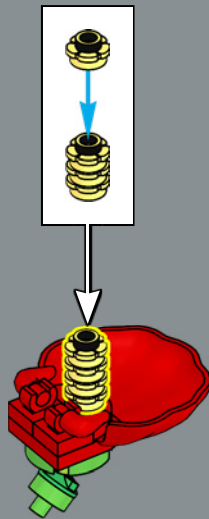

2x

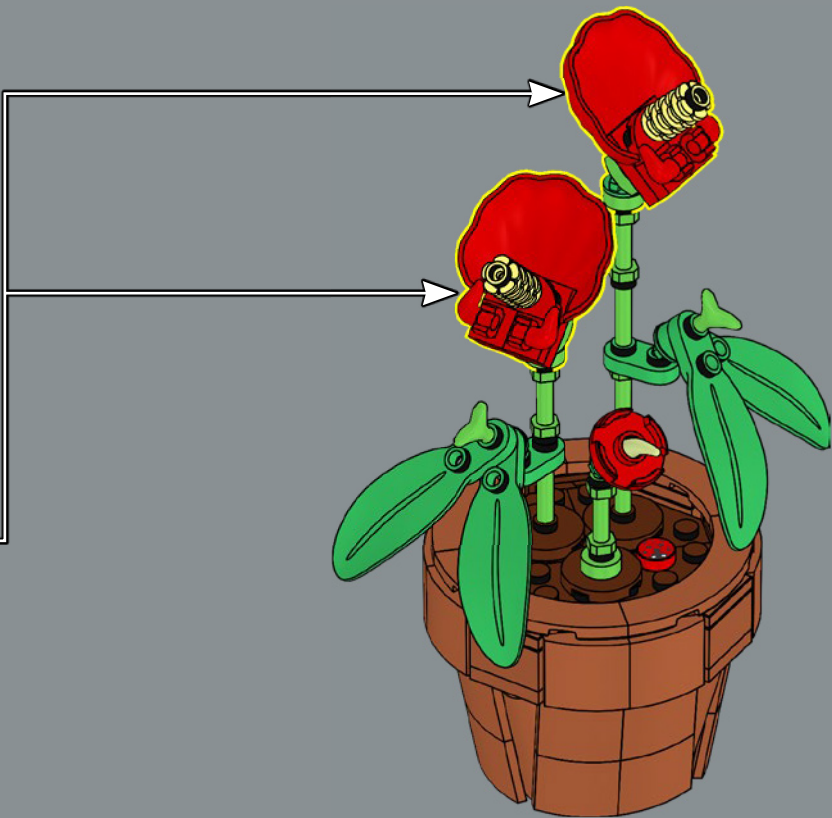



LEGO and the LEGO logo are trademarks of the LEGO Group. ©2024 The LEGO Group.