



CARNIVOROUS PLANTS

LES PLANTES CARNIVORES

PLANTAS CARNÍVORAS

These plants have developed the most cunning ways to lure in and trap their prey. With snares, pitfalls, adhesives, snap traps and other curious contraptions, these captivating creations almost seem like hybrids between flora and fauna. Over 600 different known species can gobble up a veritable buffet of gullible animals, from insects and larvae to crustaceans and even smaller mammals!

Ces plantes ont développé les moyens les plus astucieux pour attirer et piéger leurs proies. Avec des pièges à mucilage, à glu et à mâchoires, ainsi que d'autres étranges mécanismes, ces créations captivantes semblent presque être des hybrides entre la flore et la faune. Plus de 600 espèces différentes connues peuvent engloutir un véritable buffet d'animaux insouciants, des insectes aux larves en passant par les crustacés et même les petits mammifères !

Estas plantas han desarrollado las formas más ingeniosas de atraer y atrapar a sus presas. Con trampas, adhesivos, mecanismos elásticos y otros curiosos artilugios, estas cautivadoras creaciones casi podrían parecer híbridos entre flora y fauna. Más de 600 especies conocidas pueden engullir un auténtico bufet de animales crédulos, ¡desde insectos y larvas hasta crustáceos e incluso mamíferos pequeños!



(Dionaea muscipula)

VENUS FLYTRAP

Native to North Carolina and South Carolina in the United States.

LA DIONÉE ATTRAPE-MOUCHE

Une plante originaire de la Caroline du Nord et de la Caroline du Sud, aux États-Unis.

VENUS ATRAPAMOSCAS

Originaria de Carolina del Norte y Carolina del Sur, en los Estados Unidos.

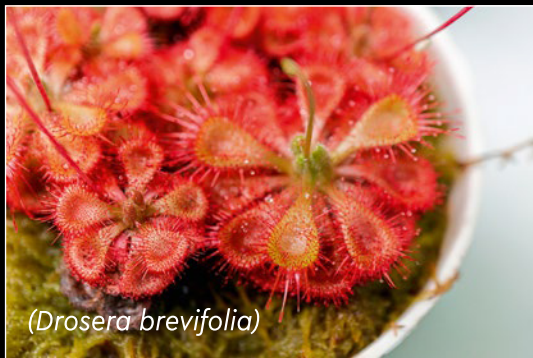

(Drosera brevifolia)

RED SUNDEW

Native to the southeastern United States.

LA PETITE ROSÉE

Originaire du Sud-Est américain.

ROCÍO DE SOL

Originaria del sudeste de Estados Unidos.



(Sarracenia flava)

YELLOW PITCHER PLANT

Native to the southeastern United States.

LA SARRACÉNIE JAUNE

Originaire du Sud-Est américain.

PLANTA CARNÍVORA AMARILLA

Originaria del sudeste de Estados Unidos.



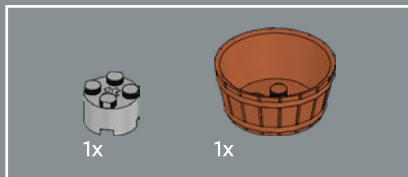

1

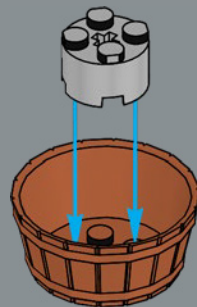

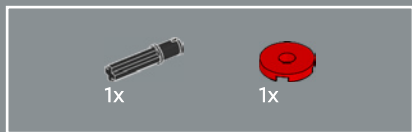

2

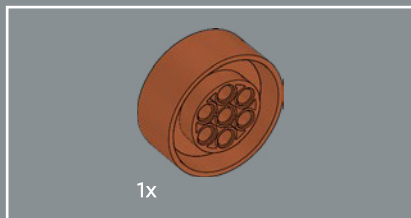
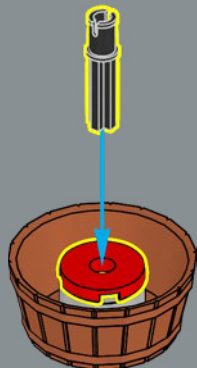

3

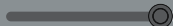
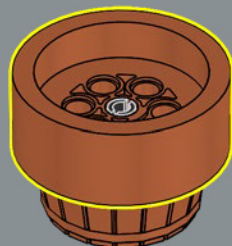



4

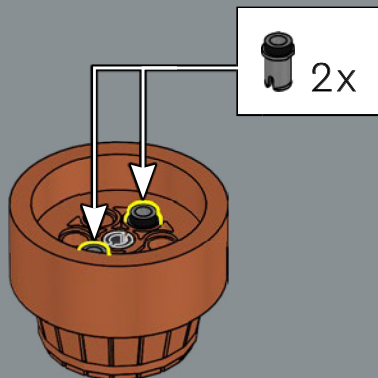

5

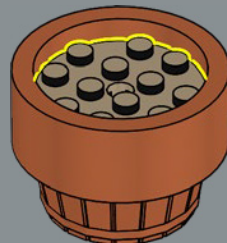

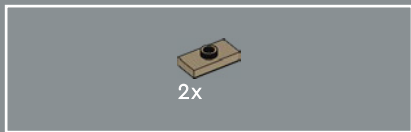

6

The Venus flytrap has sensor hairs around its two leaves that trigger its trap; when an insect touches the hairs, it will cause the jaws to close and capture the prey inside.

La dionée attrape-mouche est dotée de poils capteurs autour de ses deux feuilles qui déclenchent son piège. Lorsqu'un insecte touche les poils, les mâchoires se ferment et la proie est emprisonnée à l'intérieur.

La venus atrapamoscas tiene unos pelos sensores por los bordes de sus dos hojas que activan su trampa; cuando un insecto toca los pelos, las mandíbulas se cierran y capturan a la presa en su interior.

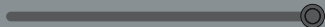
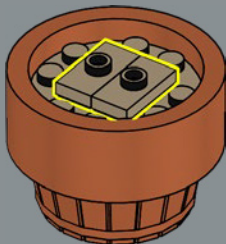



7



8





2x

9

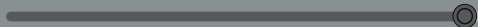

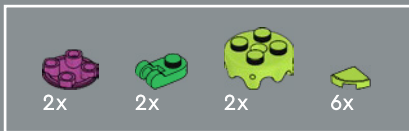

10

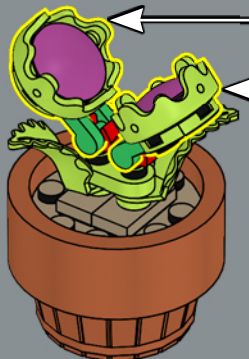
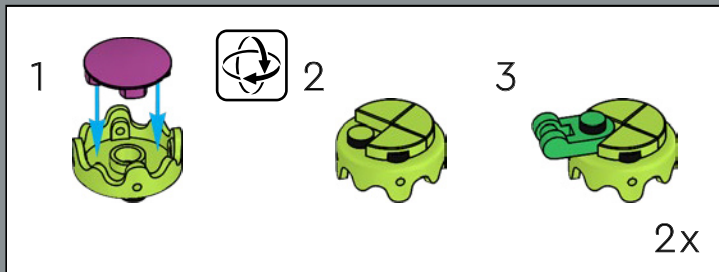

Does this piece used for the jaws of the flytrap remind you of anything? The element was originally designed as frosting for a cake. This is the first time it has been used in lime green.

Cette pièce utilisée pour les mâchoires de la dionée attrape-mouche vous rappelle-t-elle quelque chose ? L'élément a été conçu à l'origine comme glaçage pour un gâteau. C'est la première fois qu'il est utilisé en vert citron.

¿Te acuerdas a algo esta pieza utilizada para las mandíbulas de la atrapamoscas? El elemento se diseñó originalmente como glaseado para un pastel. Es la primera vez que se utiliza en verde lima.

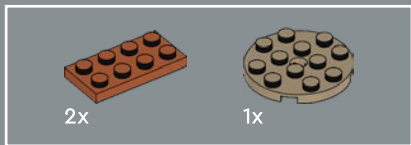
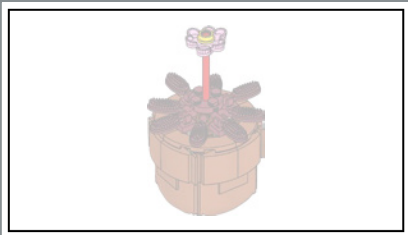

1

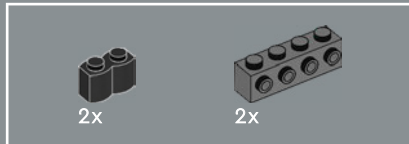
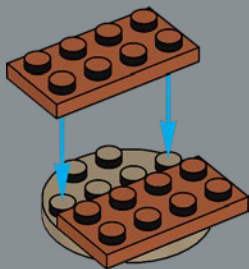

2

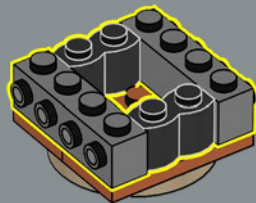

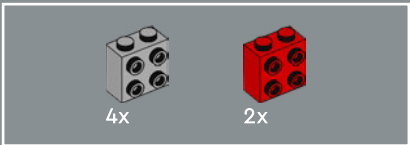

3

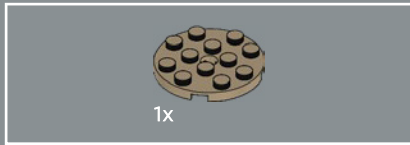
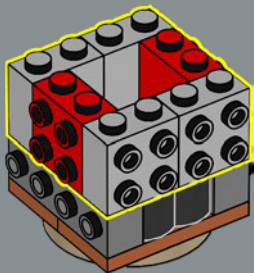

4

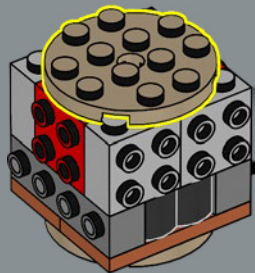

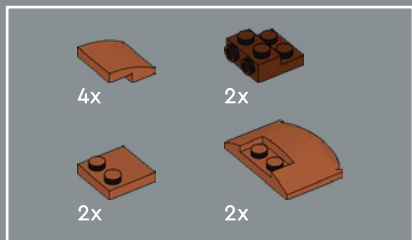

5

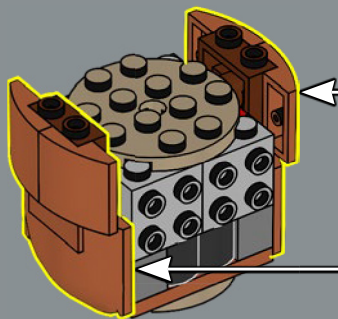
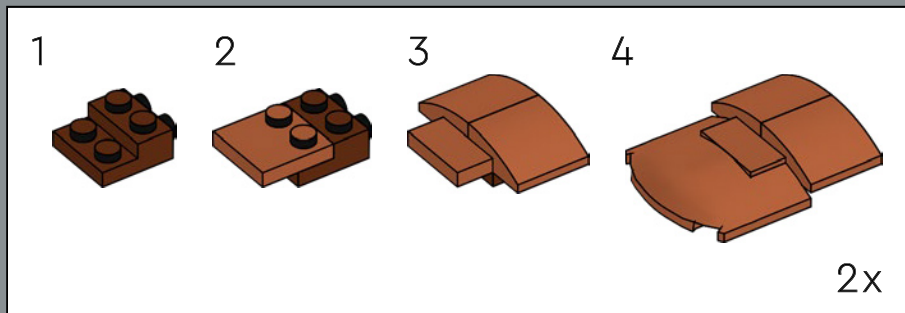

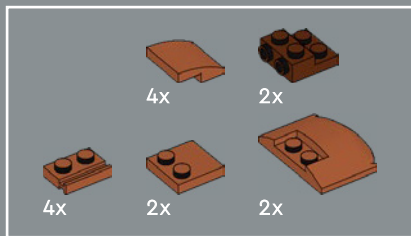

6

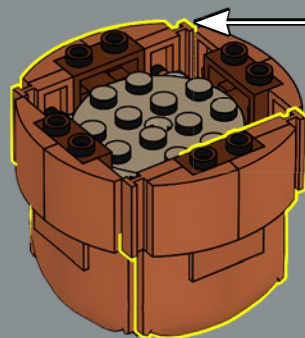
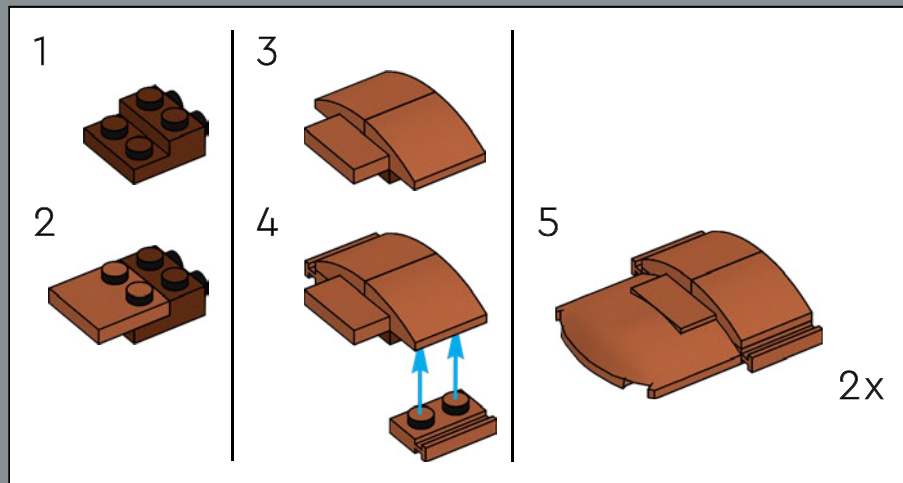

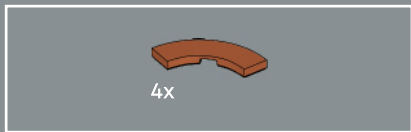

7

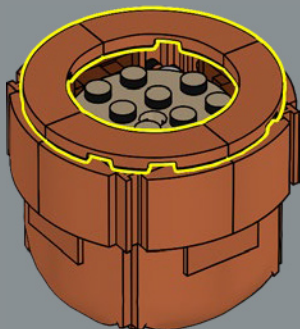

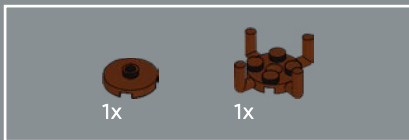

8

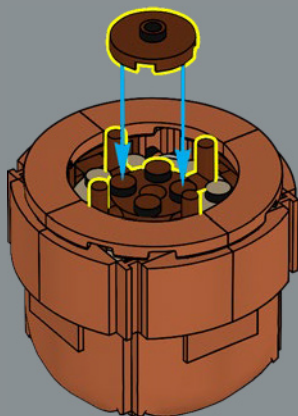

This carnivorous plant uses thousands of tiny hairs, each tipped with a bead of sticky liquid, to trap its prey. Once the insect is stuck to the leaves, they will curl inwards around the unsuspecting little bug.

Cette plante carnivore utilise des milliers de petits poils dont la pointe est recouverte d'un liquide collant pour piéger ses proies. Une fois l'insecte collé à la feuille, cette dernière se recourbe autour de la petite bestiole imprudente.

Esta planta carnívora utiliza miles de pequeños pelos rematados con una gota de líquido pegajoso para atrapar a su presa. Una vez que el insecto está pegado a sus hojas, estas se enrollan hacia adentro envolviendo al desprevenido bicho.



1x



1x

9



1x



1x

10





11

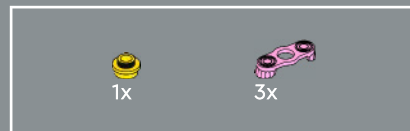
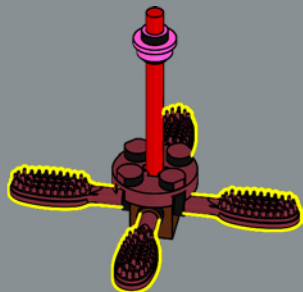

12

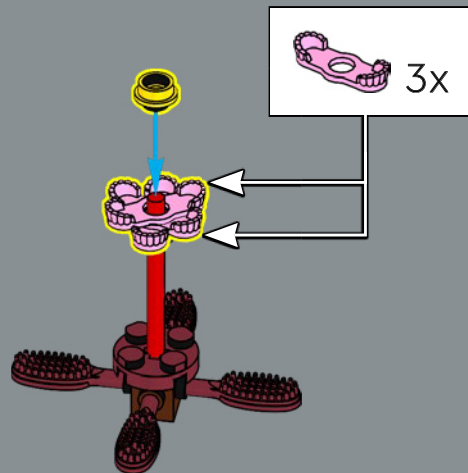

13

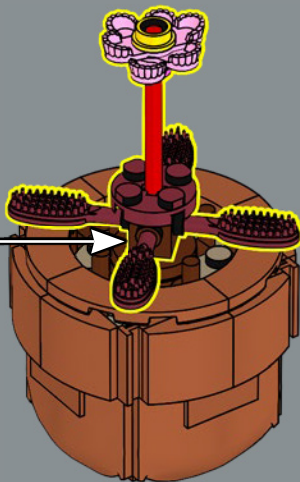

Pink epaulets make the leaves of the sundew flower, a first in this color. If you happen to have a LEGO® Captain Red Beard minifigure, you could turn him into Captain Pink Beard.

Des épaulettes roses, une première dans cette couleur, forment les feuilles de la petite rosée. Si vous possédez la figurine LEGO® du Capitaine Barbe Rouge, vous pouvez la transformer en Capitaine Barbe Rose.

Las hojas de la planta de rocío de sol son de color rosa, una primicia en este color. Si por casualidad tienes una minifigura LEGO® del Capitán Barbarroja, ahora tendrás la oportunidad de convertirlo en el Capitán Barbarrosa.



14

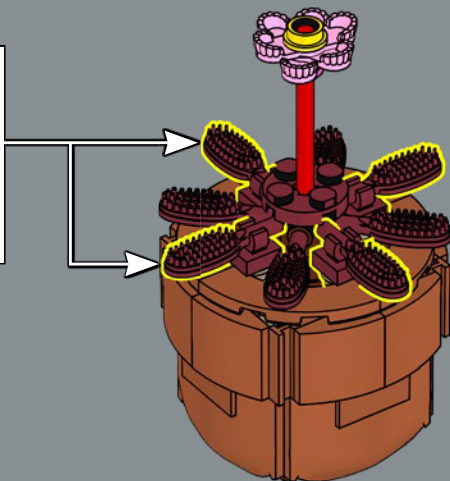
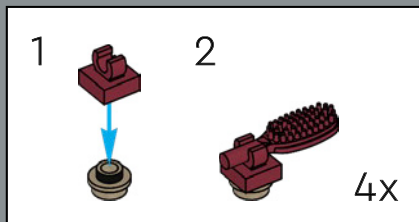

Could it be? Yes, these are actually little LEGO® hairbrushes.

Est-ce que ce sont... ? Oui, il s'agit bien de petites brosses à cheveux LEGO®.

¿Cómo es posible? Sí, en realidad se trata de pequeños cepillos LEGO®.

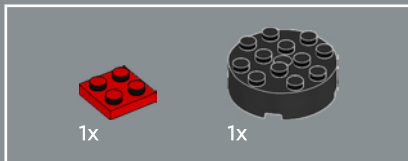
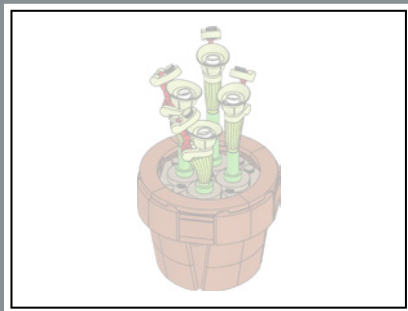

1

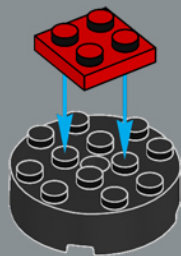



2

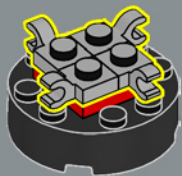

3

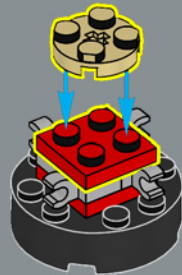

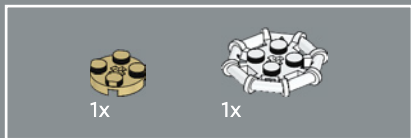

4



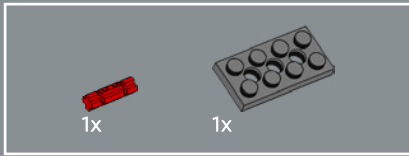

5

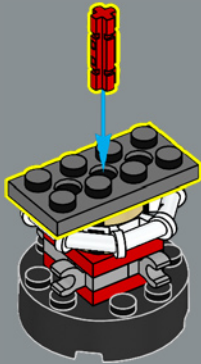

6



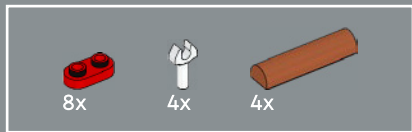

7

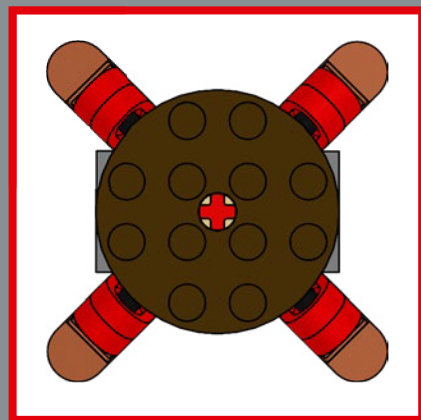
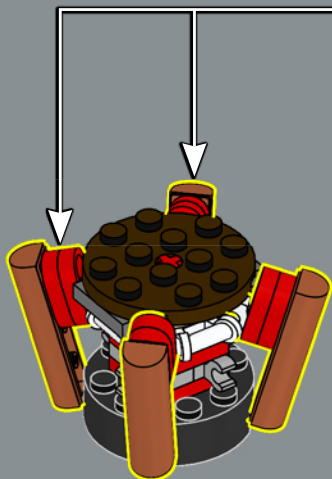
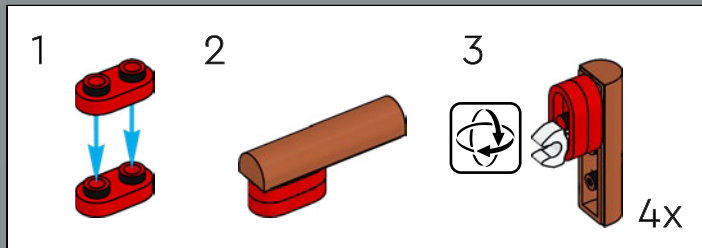

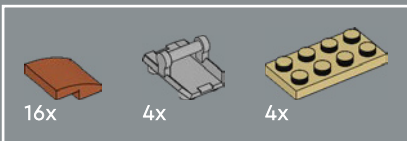

8

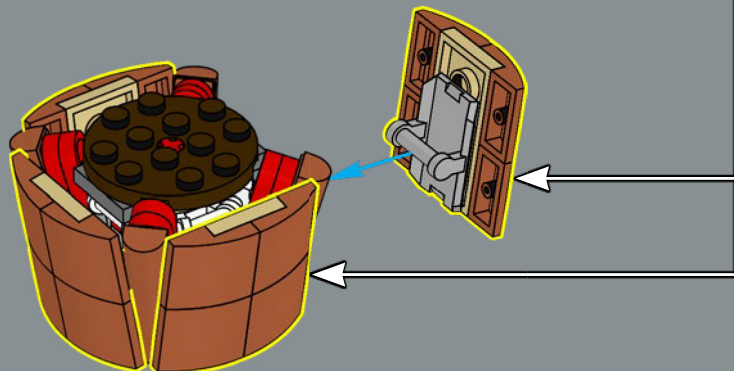
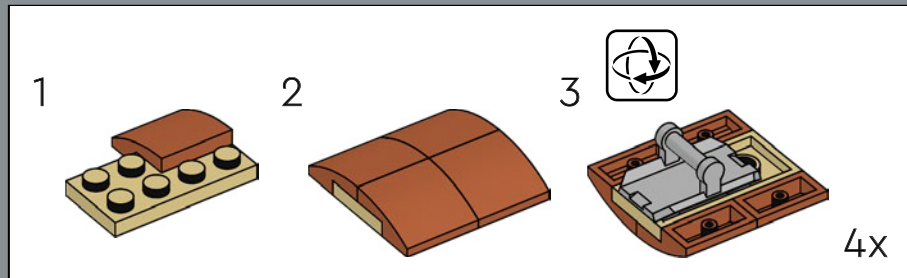

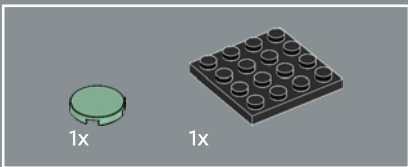
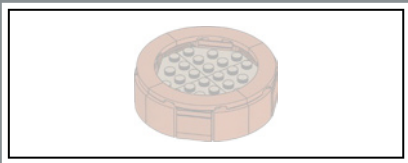

9

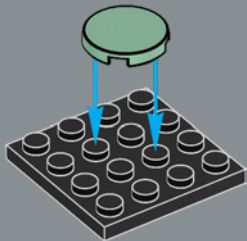



10

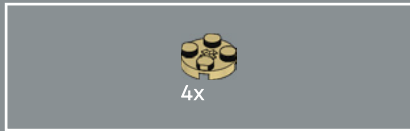
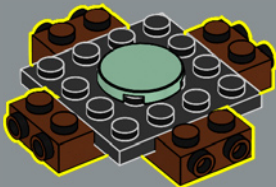

11

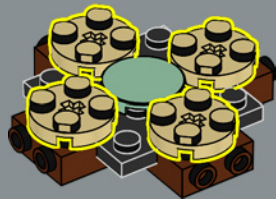



12

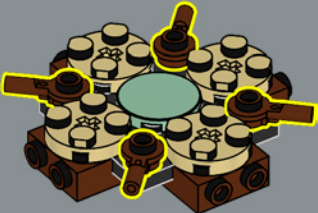

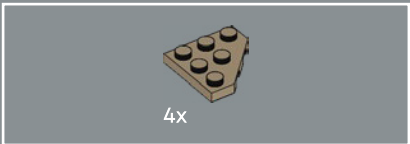

13

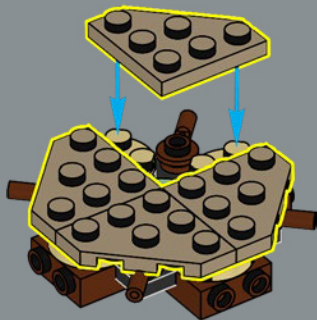



14

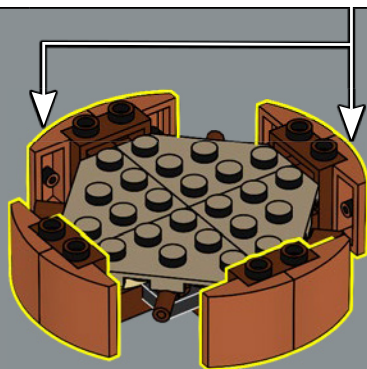
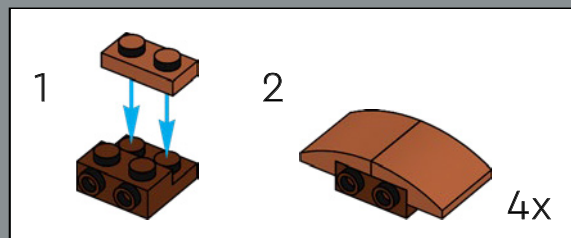

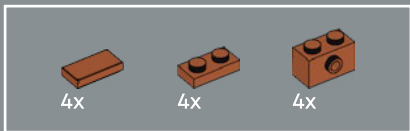

15

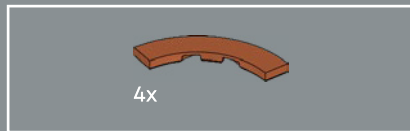
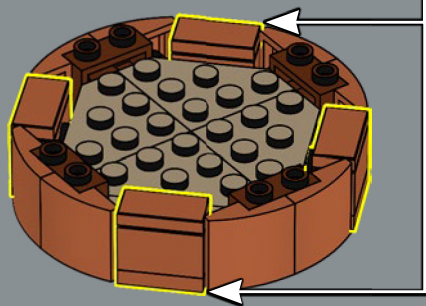
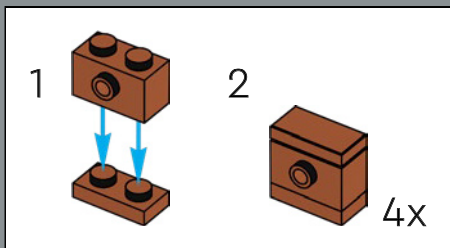

16

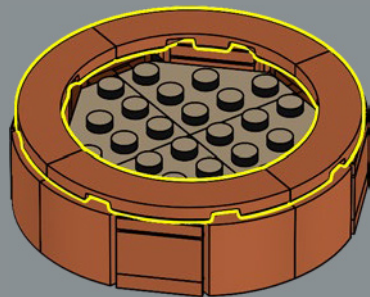

17

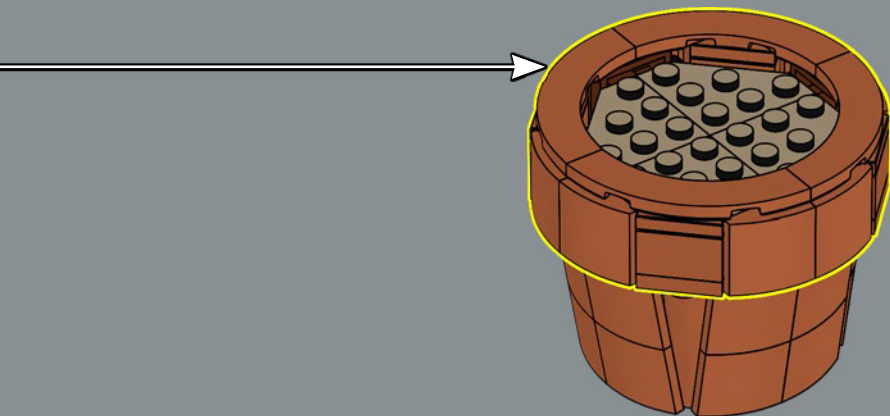

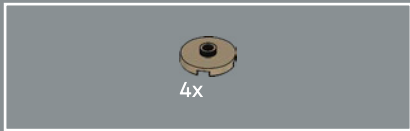

18

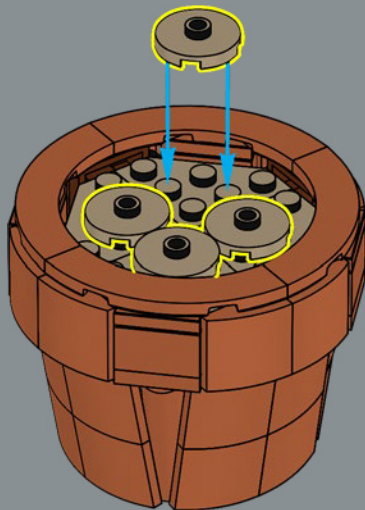



4x

19

Nothing is more refreshing than a pitcher of digestive enzymes!
The cups of these plants are filled with digestive juices to break
down the unfortunate insects that fall in.

Rien de plus rafraîchissant qu'une bonne dose d'enzymes digestives !
Les urnes de ces plantes sont remplies de suc digestifs qui
décomposent les malheureux insectes qui y tombent.

¡No hay nada más refrescante que una jarra de enzimas digestivas!
Las cavidades de las hojas de estas plantas están llenas de jugos
digestivos para descomponer a los desafortunados insectos que
caen en ellas.

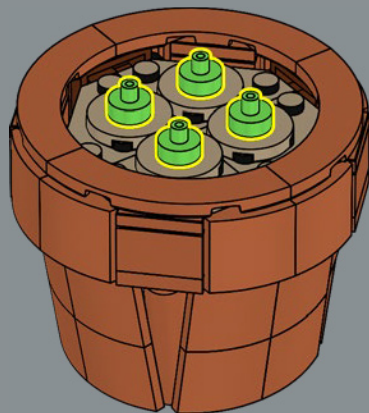



20

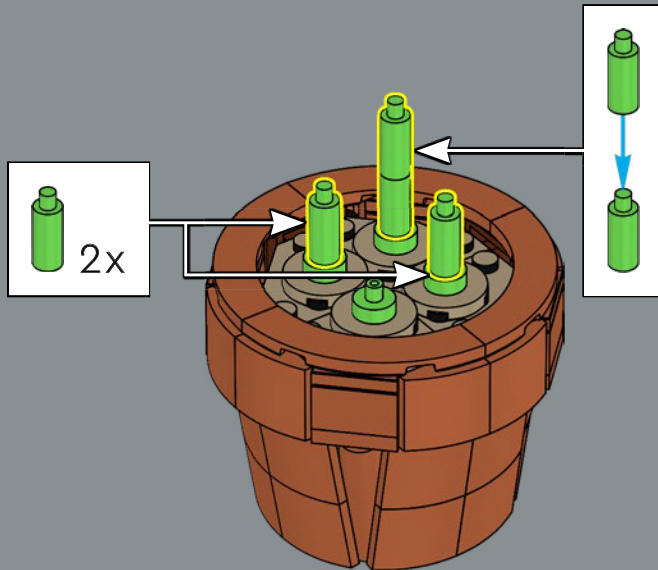

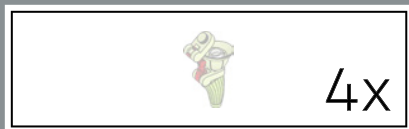

21

1

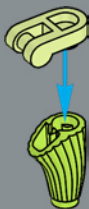

2



3



4



4x

Interesting elements alert: These pitcher plants use an explorer helmet in bright spring green for the opening of the pitcher, and a lime green broom head for the stalk.

Alerte d'éléments intéressants : Ces sarracénies utilisent un casque d'explorateur vert printemps pour l'ouverture de l'urne et une tête de balai vert citron pour la tige.

Alerta de elementos interesantes: En esta planta carnívora, se utilizó un casco de explorador de color verde brillante primaveral para reproducir la abertura de su hoja con forma de jarra y una cabeza de escoba en verde lima para el tallo.

Surprisingly, the leaf that grows above the pitcher cannot move and seal the pitcher. Instead, it prevents rain from entering and diluting the liquid within.

Étonnamment, la feuille qui pousse au-dessus de l'urne ne peut pas bouger et sceller l'urne. Elle empêche plutôt la pluie de pénétrer dans l'urne et de diluer le liquide qu'elle contient.

Sorprendentemente, la hoja que crece por encima de la "jarra" no puede moverse y sellar esta. En cambio, impide que la lluvia entre y diluya el líquido que contiene.

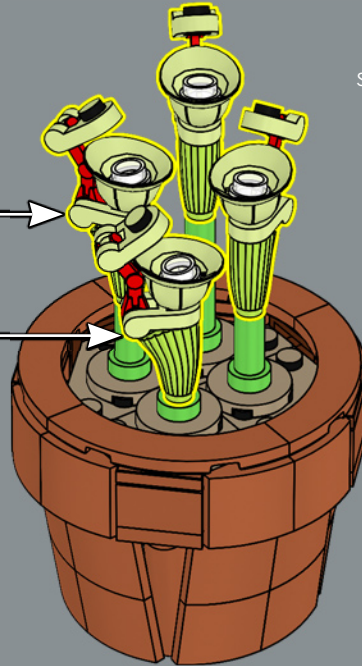



LEGO and the LEGO logo are trademarks of the/son des marques de commerce du/son marcas registradas de LEGO Group.
©2024 The LEGO Group. 6494685