

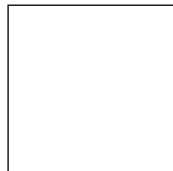

Booklet available in English on  
Livret disponible en français sur  
Folleto disponible en español en





## WE'RE MAKING OUR PACKAGING MORE SUSTAINABLE

We're transitioning from single-use plastic to paper-based packaging. As we progress, you may find a mix of paper and plastic in our boxes.

## NOUS RENDONS NOS EMBALLAGES PLUS DURABLES

Nous passons des emballages en plastique à usage unique aux emballages à base de papier. Durant la transition, vous pourriez trouver un mélange de papier et de plastique dans nos boîtes.

## QUEREMOS HACER MÁS SUSTENTABLES NUESTROS MATERIALES DE EMBALAJE

Estamos cambiando las bolsas de plástico desechables por bolsas con base de papel. Conforme avanzamos en este propósito, puedes encontrar una mezcla de papel y de plástico en nuestras cajas.

[LEGO.com/sustainable-packaging](https://LEGO.com/sustainable-packaging)

# LEGO® VIP

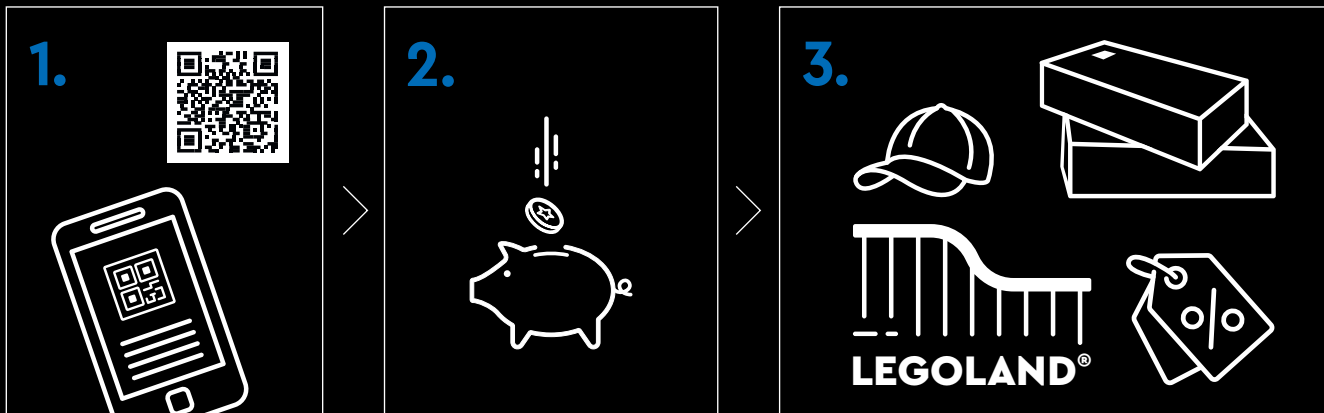

**1.** Sign up **2.** Earn points for purchases **3.** Redeem points for rewards, experiences, discounts & more | **1.** Melde dich an **2.** Sammle Punkte bei jedem Kauf **3.** Löse die Punkte für Belohnungen, Erlebnisse, Rabatte und Ähnliches ein | **1.** Inscrivez-vous **2.** Gagnez des points lors de vos achats **3.** Échangez vos points contre des récompenses, des expériences, des remises et bien plus encore | **1.** Iscriviti **2.** Guadagna punti con i tuoi acquisti **3.** Riscatta punti per premi, esperienze, sconti e altro ancora | **1.** Regístrate **2.** Gana puntos por tus compras **3.** Canjea puntos por recompensas, experiencias, descuentos y mucho más | **1.** Regíste-se **2.** Ganhe pontos em compras **3.** Troque os pontos para prêmios, experiências, descontos e muito mais | **1.** 注册 **2.** 购物赚积分 **3.** 用积分兑换奖励、体验、折扣等 | **1.** Zarejestruj się **2.** Zdobywaj punkty za zakupy **3.** Wymieniaj punkty na rabaty, przygody i inne nagrody | **1.** Zaregistrujte se **2.** Sbírejte body za nákupy **3.** Vyměňujte body za odměny, zážitky, slevy a spoustu dalšího | **1.** Zaregistrujte sa **2.** Získavajte body za nákupy **3.** Uplatnite si body a získajte odmeny, rôzne zážitky, zľavy a ešte viac | **1.** Regisztrálj **2.** Szerez pontokat minden vásárlással **3.** Váltsd be pontjaidat jutalmakra, élményekre, kedvezményekre és egyebekre | **1.** Înscrie-te **2.** Câștigă puncte pentru achiziții **3.** Valorifică puncte pentru recompense, experiențe, reduceri și multe altele | **1.** Регистріруйте се **2.** Получавайте точки за покупки **3.** Използвайте точките за награди, услуги, отстъпки и т.н. | **1.** Reģistrējies **2.** Pelni punktus par pirkumiem **3.** Izmanto punktus, lai saņemtu balvas, izklaides iespējas, atlaides un daudz ko citu | **1.** Registreeru **2.** Teeni ostude eest punkte **3.** Lunasta punktide eest preemiad, elamused, allahindlused ja muu | **1.** Užsiregistruokite **2.** Pelnykite taškus už pirkinius **3.** Panaudokite taškus atlygiui, funkcijoms, nuolaidoms ir ne tik







# CULTIVATE YOUR CREATIVE THUMB

## CULTIVEZ VOTRE POUCE CRÉATIF

### CULTIVA TU DON DE HACER FLORECER LA CREATIVIDAD

 "These humble but prolific terra-cotta pots are the latest addition to our LEGO® Botanical Collection – three groups of iconic and exotic plants, miniaturized to bring classic LEGO charm to your home. From humidity-loving houseplants to desert-dwelling succulents and peculiar carnivores, this vibrant mix of plants works as a group or in smaller sets of three, keeping their color and their fun year-round. With instructions created to make it easy for you to invite friends or loved ones to join, we hope you'll enjoy your conservatory together!"

**THEO BONNER**  
*LEGO® Model Designer*

 « Ces humbles, mais efficaces pots en terre cuite contiennent le dernier ajout à notre collection botanique LEGO® : trois groupes de plantes emblématiques et exotiques, miniaturisées pour insuffler le charme classique de LEGO dans votre maison. Des plantes d'intérieur qui aiment l'humidité aux succulentes qui vivent dans le désert, en passant par les carnivores étranges, ces plantes éclatantes peuvent être présentées ensemble ou par petits groupes de trois, et conservent leurs couleurs et leur attrait tout au long de l'année. Les instructions ont été conçues pour vous permettre de construire avec vos amis ou vos proches. Nous espérons que vous profiterez de votre jardin ensemble ! »

**THEO BONNER**  
*Concepteur de modèles LEGO®*

 "Estas humildes, pero prolíficas macetas de terracota son la incorporación más reciente a nuestra colección LEGO® Botanical: tres grupos de plantas tan emblemáticas como exóticas miniaturizadas para llevar el clásico encanto de LEGO a tu hogar. Incorporando desde plantas para interiores que aman la humedad hasta suculentas que habitan en el desierto y peculiares especímenes carnívoros, esta vibrante mezcla de especies vegetales funciona como un grupo o en conjuntos más pequeños de tres que conservan su color y la diversión todo el año. Con instrucciones creadas para que te resulte fácil invitar a tus amigos o seres queridos a compartir la experiencia, ¡esperamos que disfruten juntos de su baluarte vegetal en miniatura!"

**THEO BONNER**  
*Modelista de LEGO®*



## TROPICAL PLANTS

## LES PLANTES TROPICALES

## PLANTAS TROPICALES

☞ Tropical rainforests cover only around 6% of the Earth's surface, yet they are home to nearly two-thirds of all plant species, including plants with medicinal properties used in the treatment of a variety of illnesses. The warm, humid conditions allow thousands of vibrant, lush flowers, trees and bushes to thrive and serve as shelter and nourishment for animals and humans alike.

☞ Les forêts tropicales humides ne couvrent qu'environ 6 % de la surface de la Terre, mais elles abritent près des deux tiers de toutes les espèces végétales, y compris des plantes aux propriétés médicinales utilisées dans le traitement d'un grand nombre de maladies. Les conditions chaudes et humides permettent à des milliers de fleurs, d'arbres et de buissons vifs et luxuriants de prospérer et de servir d'abri et de nourriture aux animaux comme aux humains.

☞ Las selvas tropicales solo cubren alrededor del 6 % de la superficie de la Tierra, pero albergan casi dos tercios de todas las especies vegetales, incluidas múltiples plantas con propiedades medicinales utilizadas en el tratamiento de diversas enfermedades. La combinación de calor y humedad permite que prosperen miles de flores, árboles y arbustos tan vibrantes como exuberantes que sirven de refugio y alimento a animales y humanos por igual.



*(Oxalis triangularis)*

**FALSE SHAMROCK**

A perennial plant native to Argentina, Bolivia, Brazil, Paraguay and Peru.

**LE FAUX TRÈFLE**

Une plante vivace originaire d'Argentine, de Bolivie, du Brésil, du Paraguay et du Pérou.

**TRÉBOL PÚRPURA**

Planta perenne originaria de Argentina, Bolivia, Brasil, Paraguay y Perú.



*(Crassula ovata)*

**JADE PLANT**

A large succulent native to South Africa and Mozambique.

**L'ARBRE DE JADE**

Une grande succulente originaire d'Afrique du Sud et du Mozambique.

**ÁRBOL DE JADE**

Una enorme succulenta originaria de Sudáfrica y Mozambique.



*(Anthurium andraeanum)*

**LACELEAF**

A flowering plant native to Columbia and Ecuador.

**LA LANGUE DE FEU**

Une plante à fleurs originaire de Colombie et d'Équateur.

**ANTURIO**

Planta con flores originaria de Colombia y Ecuador.

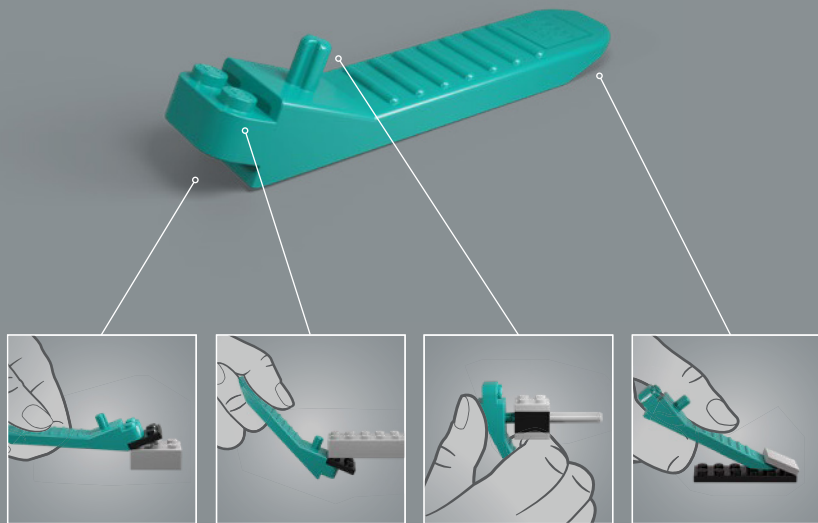





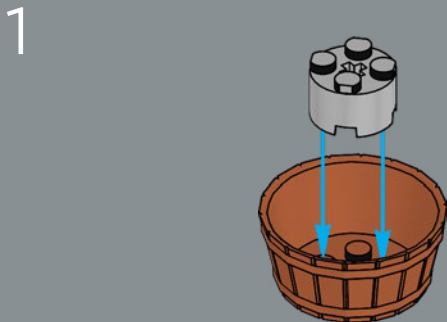
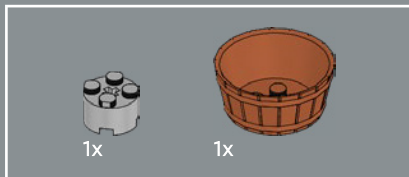

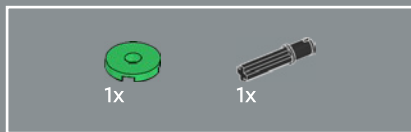

2

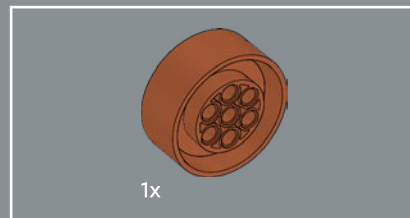
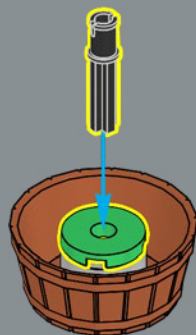

3

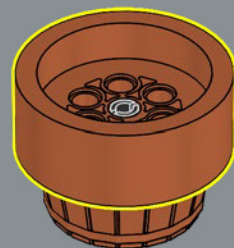



4

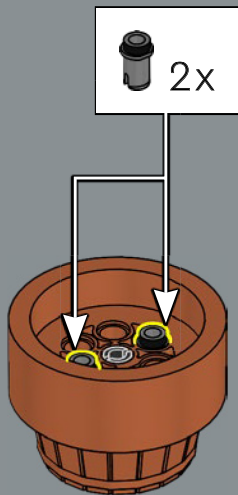

5

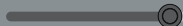



6

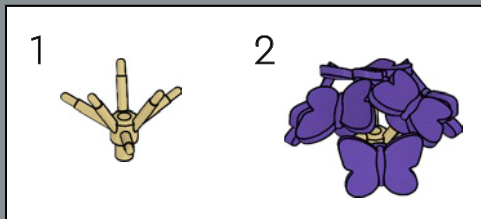

At a glance, *Oxalis triangularis* could be mistaken for a large group of butterflies, so what better way to capture this plant's iconic look than by using the LEGO® butterfly in a brand-new color.

Au premier coup d'œil, l'oxalis pourrait être confondu avec un grand groupe de papillons, alors quoi de mieux que d'utiliser le papillon LEGO® dans une toute nouvelle couleur pour saisir l'aspect emblématique de cette plante ?

A primera vista, el trébol púrpura podría confundirse con un enorme grupo de mariposas, así que qué mejor manera de capturar el icónico aspecto de esta planta que utilizando mariposas LEGO® en un color totalmente nuevo.

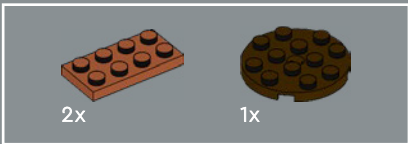
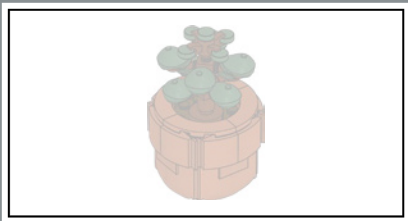

1

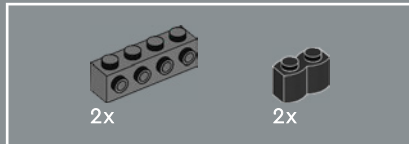
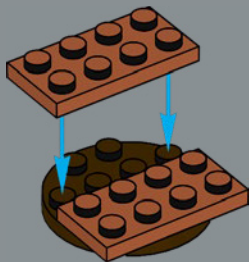

2

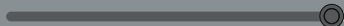
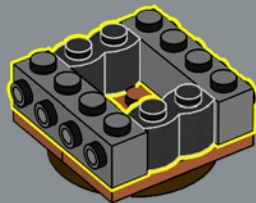

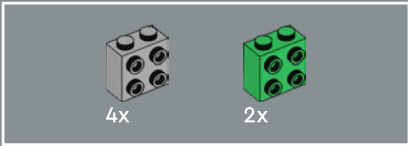

3

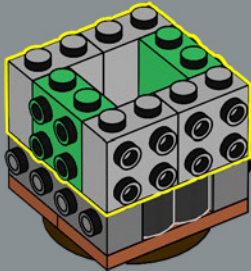

4

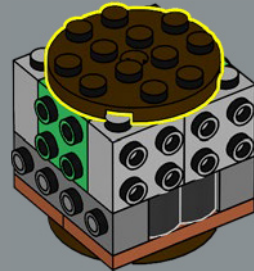

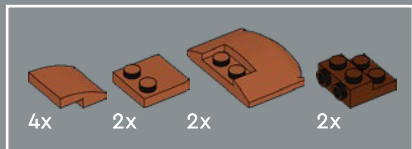

5

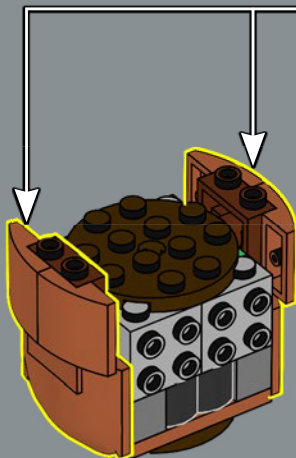
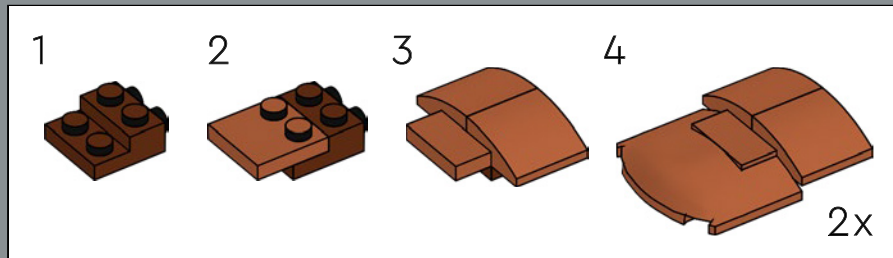



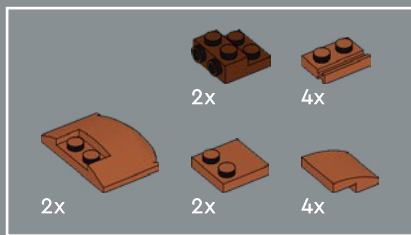

6

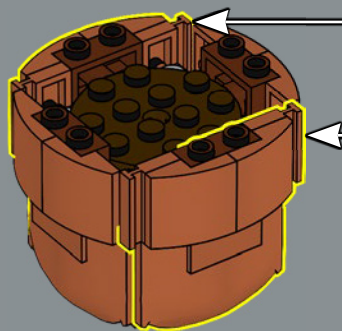
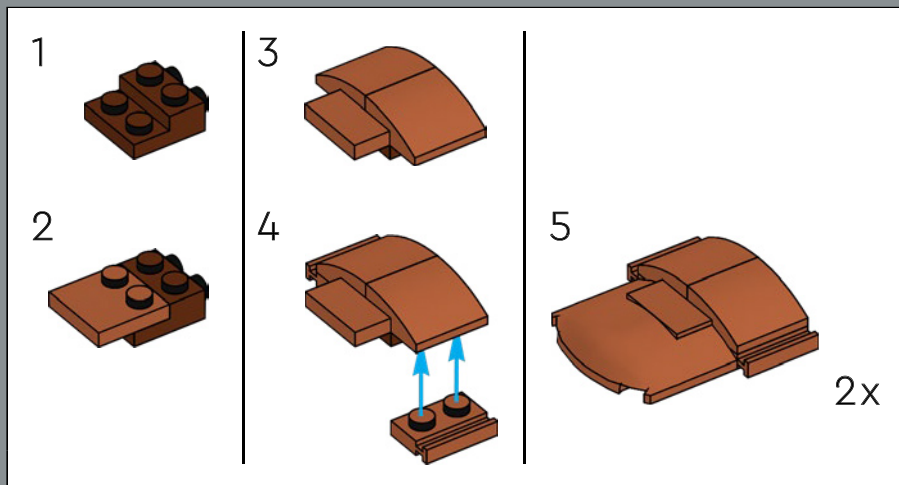

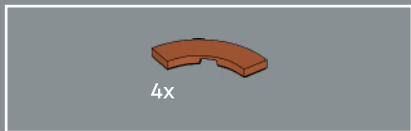

7

Have you ever considered learning the art of growing bonsai trees?  
Jade plants grow fast, are very accommodating and can easily be trimmed to your liking.

Avez-vous déjà envisagé d'apprendre l'art de la culture des bonsaïs ?  
Les arbres de Jade poussent rapidement et sont très dociles. Ils peuvent facilement être taillés à votre convenance.

¿Has pensado alguna vez en aprender el arte de cultivar bonsáis?  
Los árboles de jade crecen rápido y son muy adaptables. Además, puedes recortarlos a tu gusto con facilidad.

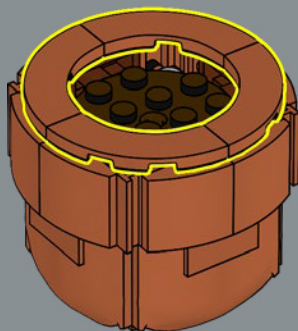



8



9

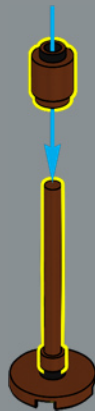



10

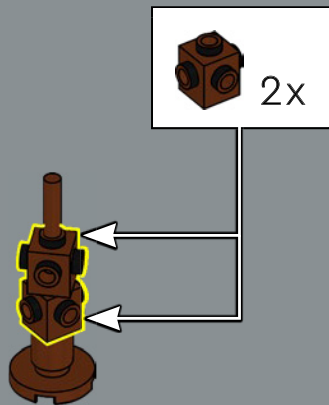

11

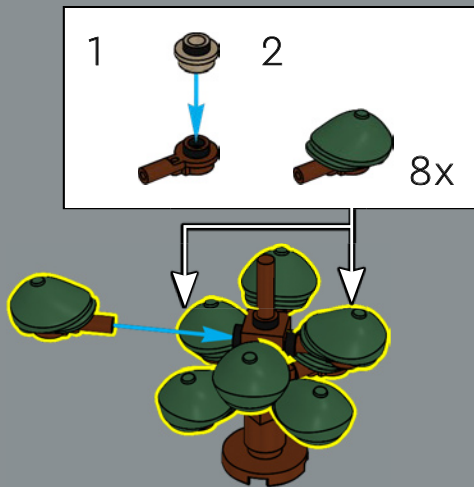

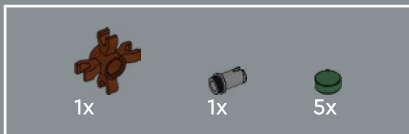

12

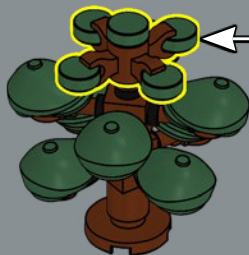

Extra! Extra! Read all about it! Flat cap in a new color! To replicate the thick leaves of the jade plant, we used eight LEGO® flat caps first seen in the Newspaper Kid Collectible LEGO Minifigure.

Oyé ! Oyé ! Découvrez tous les détails ! Casquette plate dans une nouvelle couleur ! Pour reproduire les feuilles épaisses de l'arbre de Jade, nous avons utilisé huit casquettes plates LEGO®, vues la première fois sur la figurine LEGO à collectionner du livreur de journaux.

¡Extra! ¡Extra! ¡Léelo todo! ¡Boina plana en un nuevo color! Para reproducir las gruesas hojas del árbol de jade, utilizamos ocho boinas planas LEGO® vistas por primera vez en la minifigura LEGO coleccionable del Chico de los Periódicos.

13

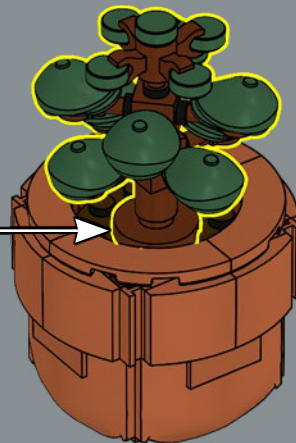

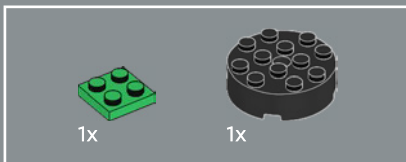
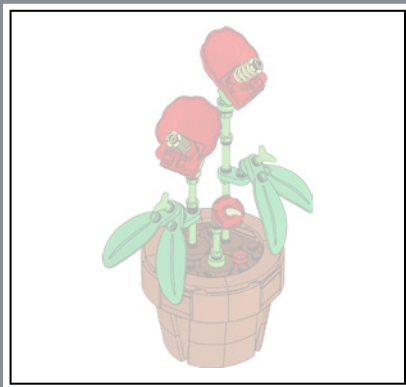

1

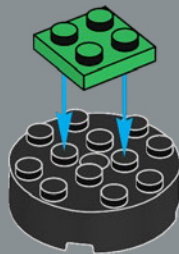

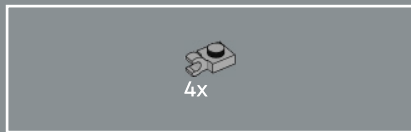

2

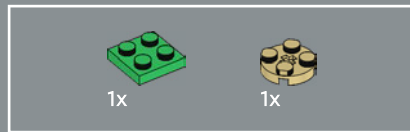
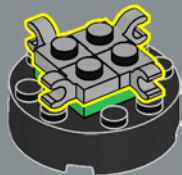

3

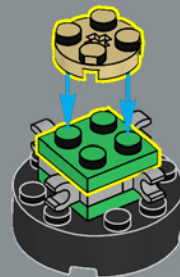

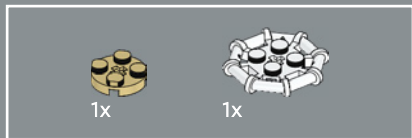

4

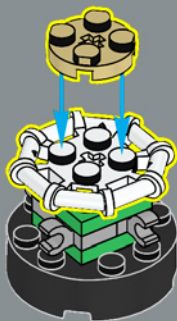



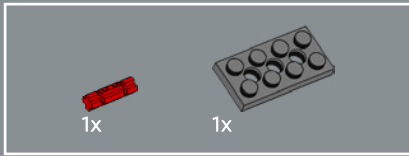

5

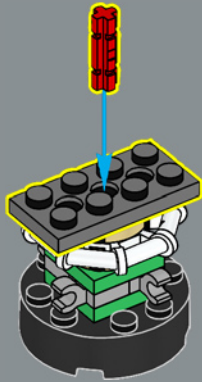

6



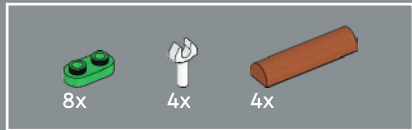

7

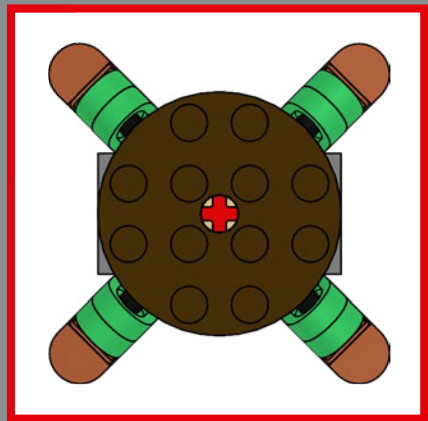
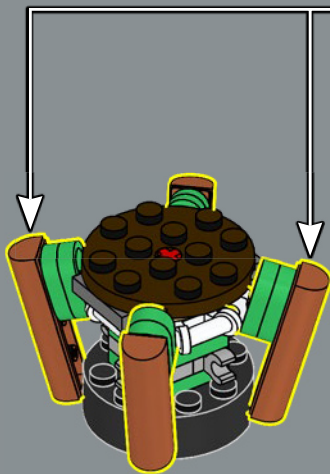
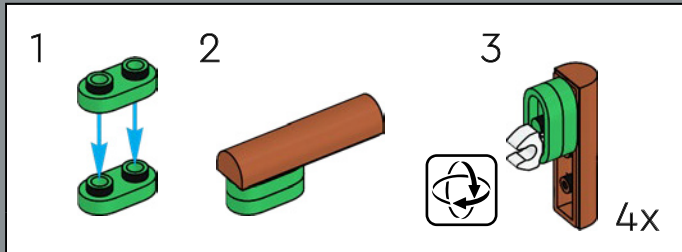

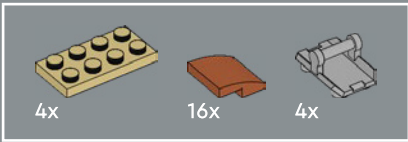

8

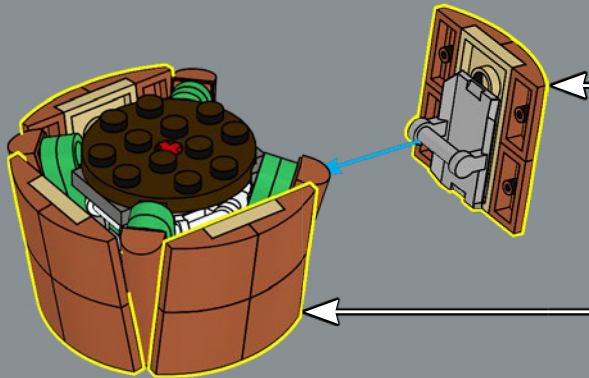
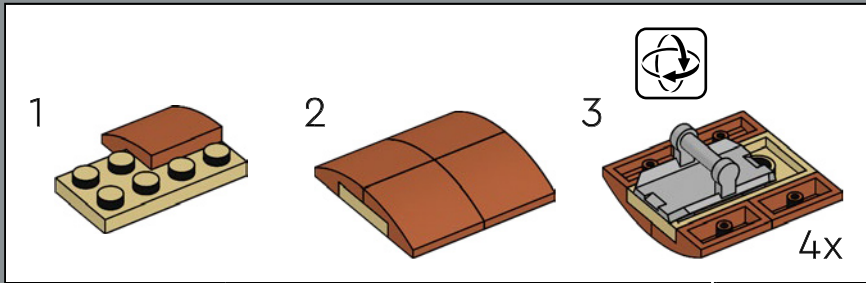

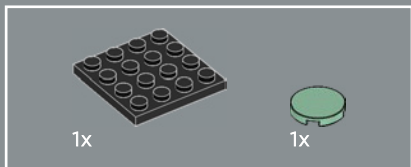
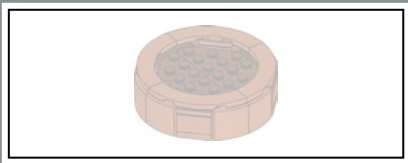

9

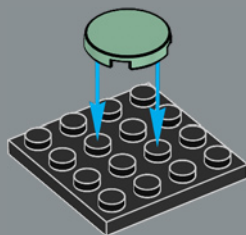



10

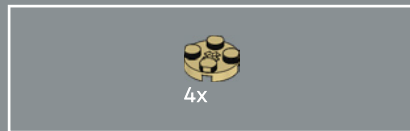
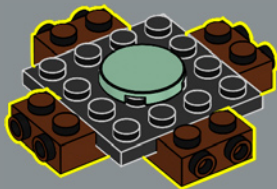

11

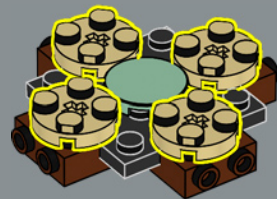



12

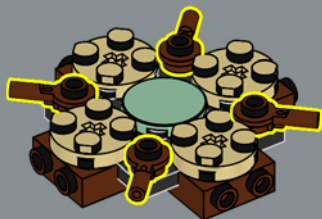

13

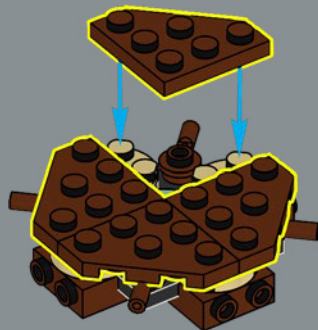



14

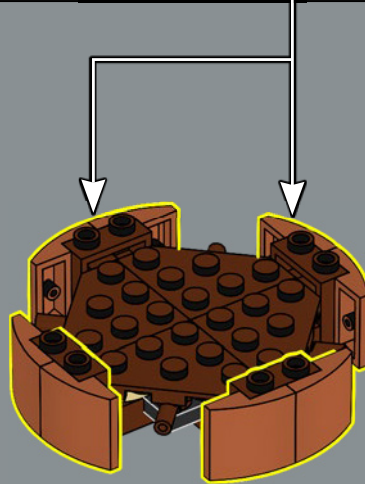
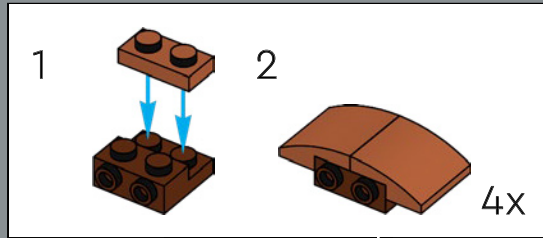

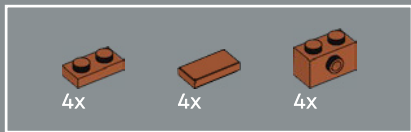

15

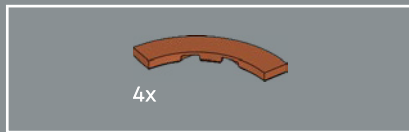
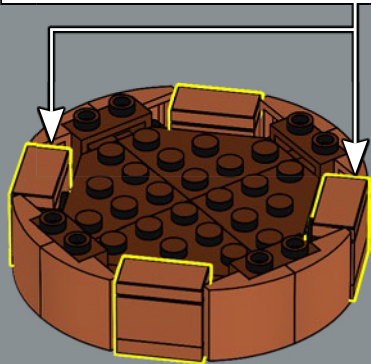
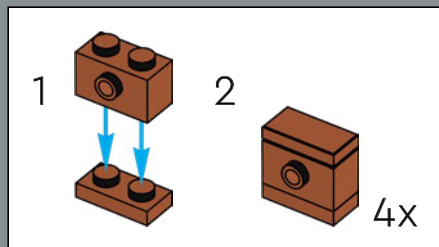

16

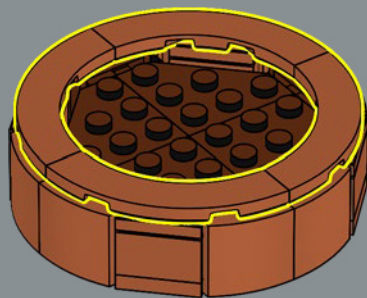



Laceleaves are susceptible to pests like aphids and spider mites, so having a hungry ladybug in the pot is a good way to keep your plant healthy.

Les langues de feu sont vulnérables aux parasites tels que les pucerons et les tétranyques. La présence d'une coccinelle affamée dans le pot est donc un bon moyen de garder la plante en bonne santé.

Los anturios son susceptibles a plagas como los pulgones y los ácaros, así que tener una catarina hambrienta en la maceta es una buena forma de mantener sana tu planta.

17

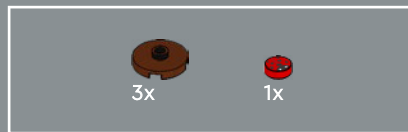
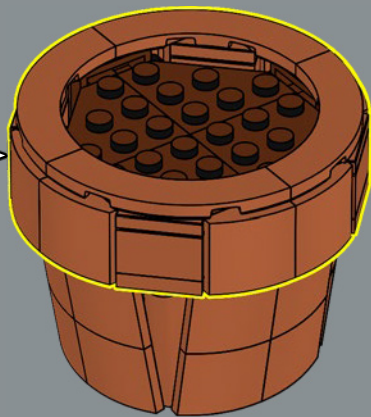

18

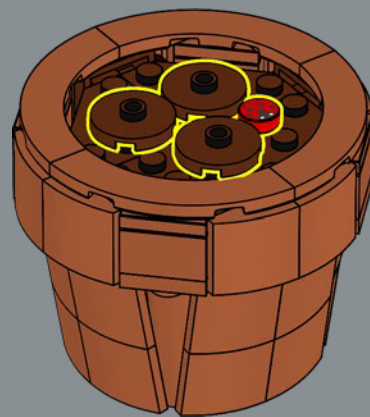



19

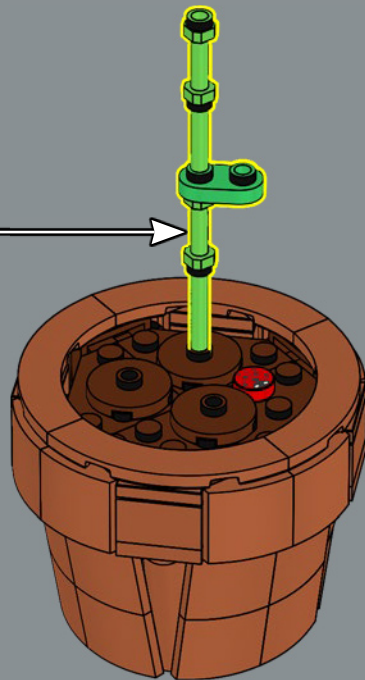
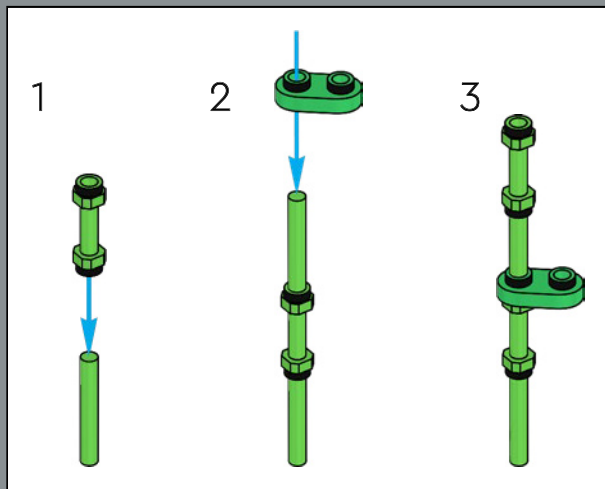

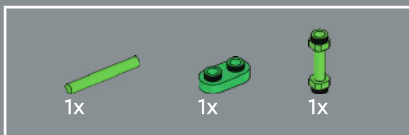

20

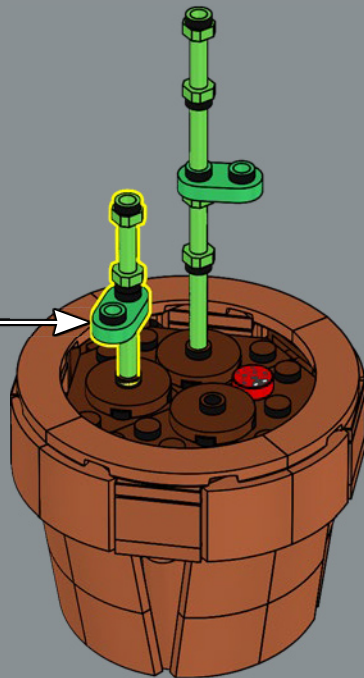
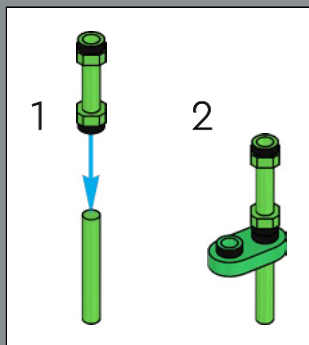

You may also know laceleaf (or Anthurium) by one of its many other names, for example, flamingo flower or painter's palette. We love the abundance of alliteration here!

La langue de feu (ou Anthurium) est aussi connue sous le nom « flamant rose ». Elle porte bien ses noms aussi colorés que ses fleurs !

También es posible que conozcas los anturios por alguno de sus muchos otros nombres como, por ejemplo, flor de flamenco o paleta de pintor. ¡Nos encantan esas aliteraciones!

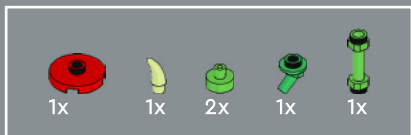

21

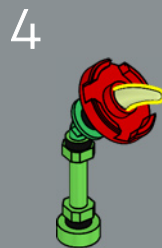
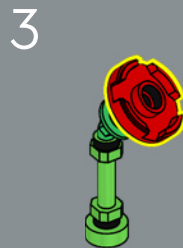
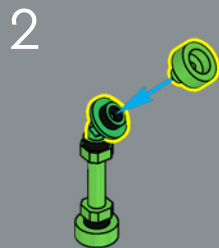
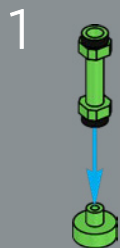

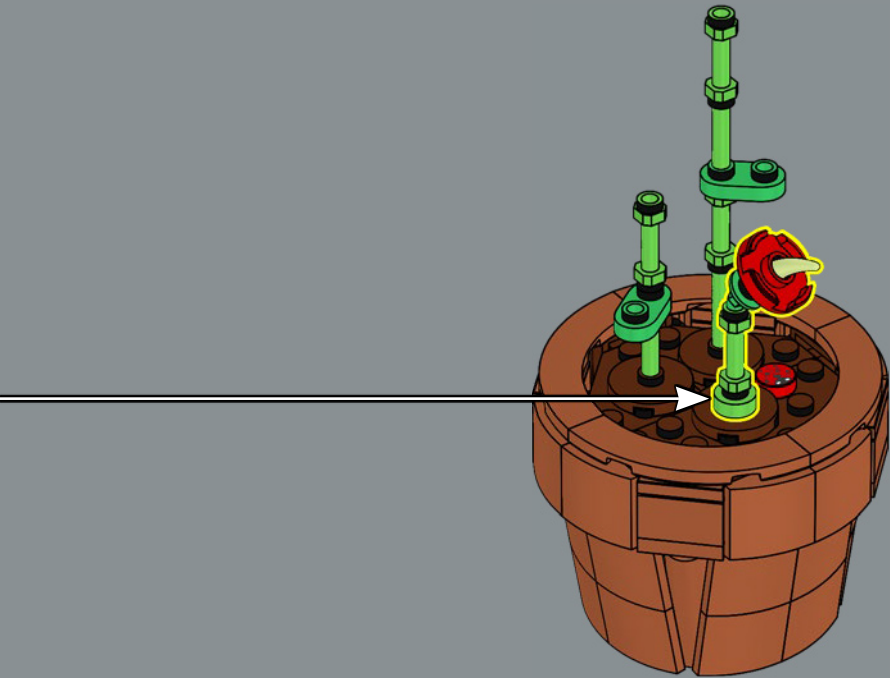

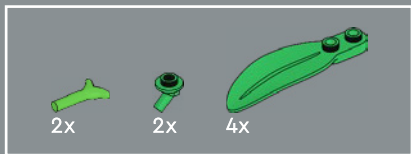

22

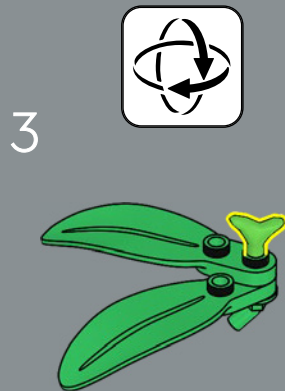
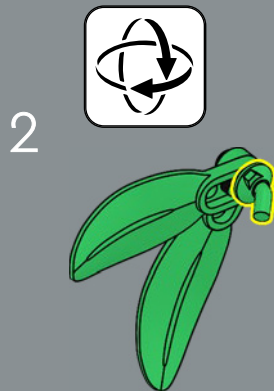
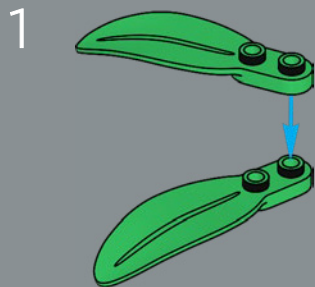

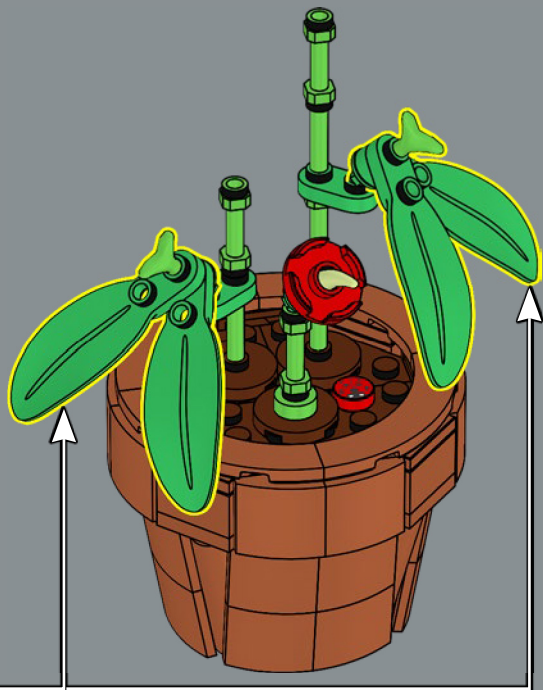



2x



2x



8x



2x



2x



2x



4x



4x



2x



2x

23

1

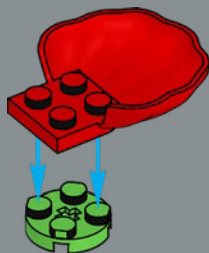

2

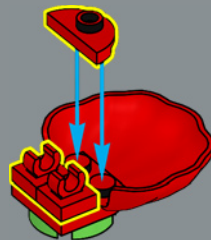



To capture the iconic ridged flower of the laceleaf, we used LEGO® clam shell elements in a new color.

Pour reproduire la fleur nervurée emblématique de la langue de feu, nous avons utilisé des éléments LEGO® de coquille de palourde dans une nouvelle couleur.

Para capturar la icónica flor estriada del anturio, utilizamos elementos LEGO® que representan conchas de almejas en un nuevo color.

3

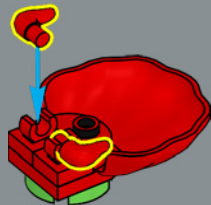

4

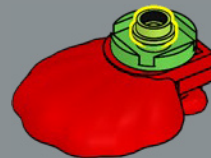

5

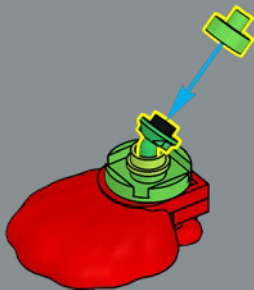

6

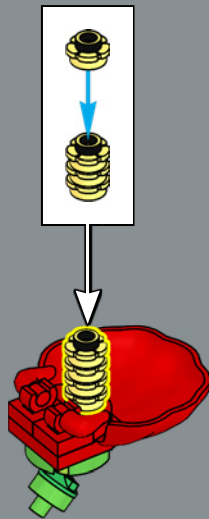

2x

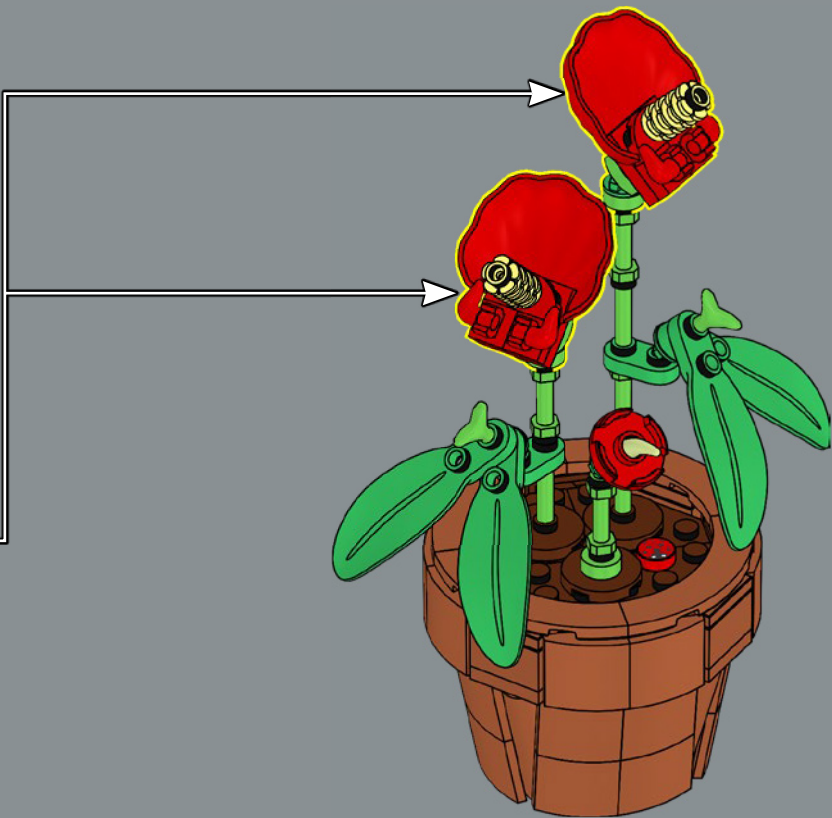



LEGO and the LEGO logo are trademarks of the/son des marques de commerce du/son marcas registradas de LEGO Group.  
©2024 The LEGO Group. 6494684